

COBOT Accessories

Parts Feeder - Pedestals - Mobile Cart - Mobile Base

Parts Feeder

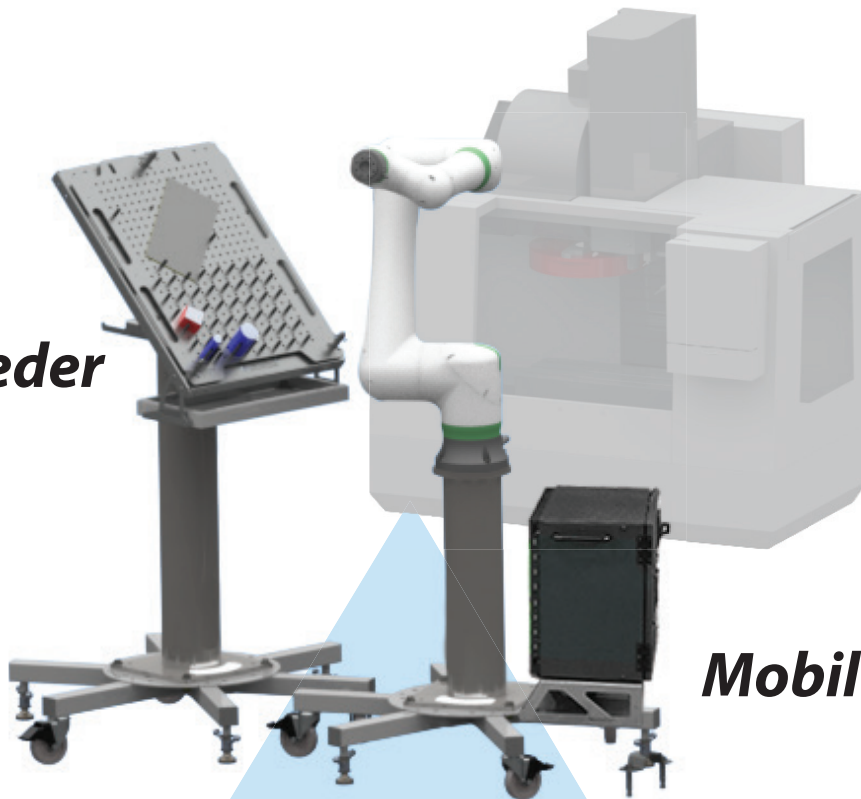

Mobile Base

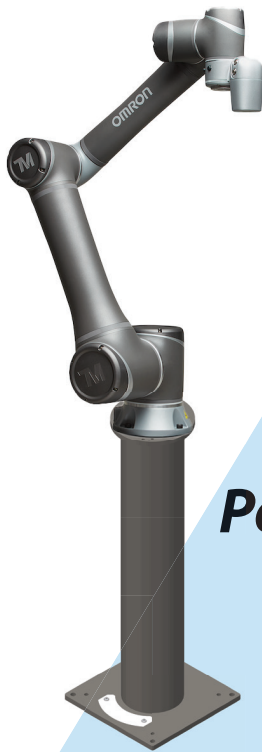

Pedestals



Mobile Cart

COBOT Parts Feeder



45° Parts Feeder Kit

Includes:

- ✓ Parts platform
- ✓ 45° base adapter
- ✓ Template storage rack
- ✓ Catch pan & brackets
- ✓ COBOT pedestal



RB-PPS-12CB200-45KIT - Kit with 12" COBOT Pedestal

RB-PPS-18CB200-45KIT - Kit with 18" COBOT Pedestal

RB-PPS-24CB200-45KIT - Kit with 24" COBOT Pedestal

RB-PPS-30CB200-45KIT - Kit with 30" COBOT Pedestal

RB-PPS-36CB200-45KIT - Kit with 36" COBOT Pedestal

RB-PPS-42CB200-45KIT - Kit with 42" COBOT Pedestal

RB-PPS-48CB200-45KIT - Kit with 48" COBOT Pedestal

COBOT Parts Feeder Add-ons

Parts Feeder Templates

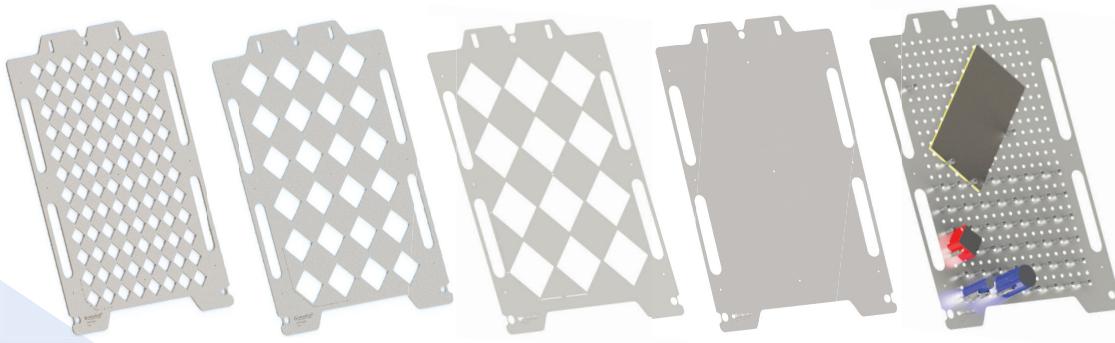

RB-PFT-3096
30mm spacing
holds 96 parts

RB-PFT-6024
60mm spacing
holds 24 parts

RB-PFT-9012
90mm spacing
holds 12 parts

RB-PFT-BLANK
Design your own
or use as spacer

RB-PFT-PB25
Adjustable pegboard

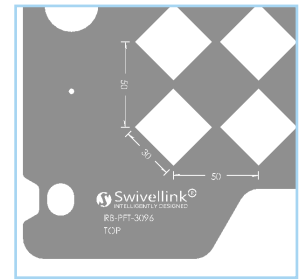

Center-to-center spacing cut
into templates

- ✓ Heavy-duty stainless-steel
- ✓ Set up information cut into template
- ✓ Robot calibration touch off indicators

- ✓ Diamond patterns settle parts into V for precise location
- ✓ Stackable templates to support taller material blanks
- ✓ Precision location to parts feeder base locater pins

Stackable Pins
for use with RB-PFT-PB25



RB-PFT-PEG25

Other Accessories

Catch Pan

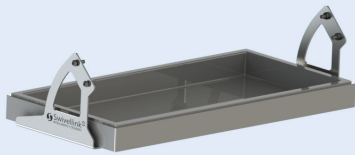

RB-PFT-CATCHPAN-KIT

- Heavy-duty stainless-steel brackets
- Mounting hardware included
- Stain resistant plastic tray
- 1 gallon capacity
- Easy load and removal

Parts Feeder Platforms

- Heavy-duty stainless-steel
- Mounting hardware included



RB-PFT-15BASE-KIT



RB-PFT-45BASE-KIT

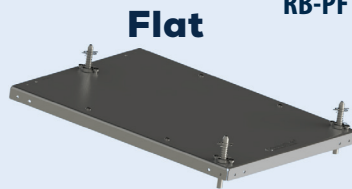

RB-PFT-BASE-KIT

Storage Rack for Templates

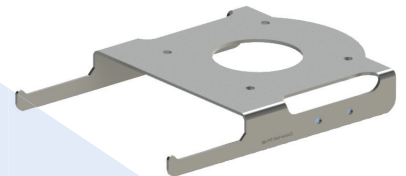

RB-PFT-TMPHANG

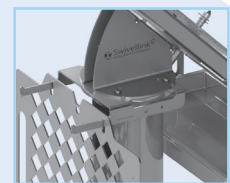

Mobile Base



Mobile Base shown with
COBOT pedestal and anchor,
both sold separately

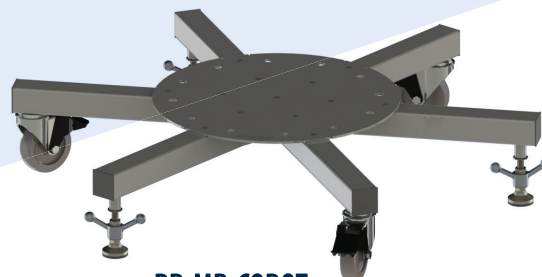

RB-MB-COBOT



RB-MB-ANCHOR
(sold separately)

COBOT Pedestals

height measurement = base to base



- RB-PED-12-CB200** - 12" COBOT Pedestal
- RB-PED-18-CB200** - 18" COBOT Pedestal
- RB-PED-24-CB200** - 24" COBOT Pedestal
- RB-PED-30-CB200** - 30" COBOT Pedestal
- RB-PED-36-CB200** - 36" COBOT Pedestal
- RB-PED-42-CB200** - 42" COBOT Pedestal
- RB-PED-48-CB200** - 48" COBOT Pedestal

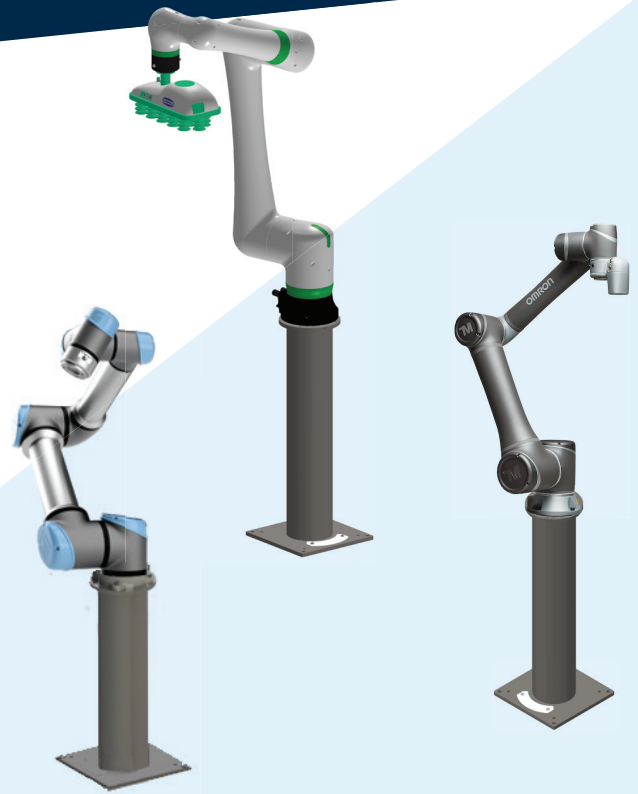

- ✓ CB200 series mounts the UR3, UR3e, UR5, UR5e, UR10, UR10e, UR16, UR16e, FANUC CRX-10iA, CRX-10iA/L, Omron TM5, TM12, TM14
- ✓ Designed with a thru-hole for routing cables, providing a nice clean look
- ✓ Holes for leveling and anchoring
- ✓ RAL7010 Powder Coat Finish
- ✓ Welded Construction

Other Accessories

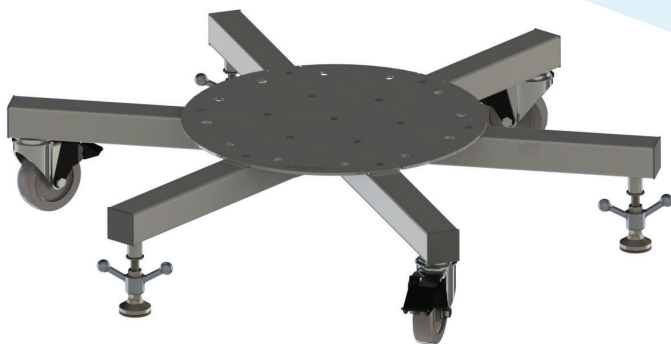

RB-MB-COBOT

Mobile Base

- ✓ Heavy duty welded steel construction
- ✓ Standard gray powder coated finish
- ✓ Total locking swivel and wheel brakes
- ✓ Industrial swivel leveling feet for stability
- ✓ Non-slip pads on each leveling foot
- ✓ Accommodates all Swivellink COBOT pedestals
- ✓ Mounting hardware included
- ✓ Large footprint for stability
- ✓ Base can be locked in 30° increments

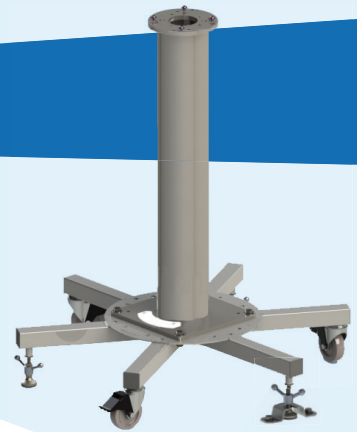

COBOT pedestal shown with Mobile Base, sold separately



RB-MB-ANCHOR
(sold separately)

Controller Bracket

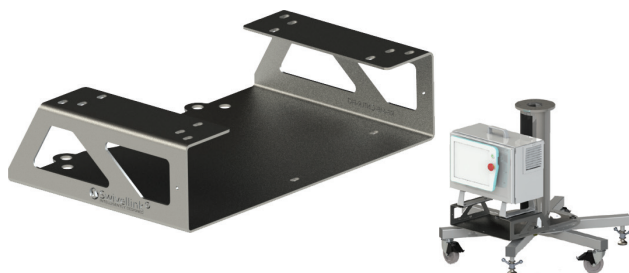

RB-MB-CNTRLR-BKT

45° Base Adapter

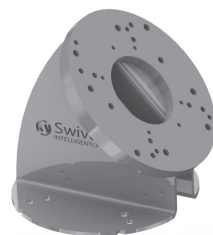

RB-45ADAPTER-CB200

15° Base Adapter

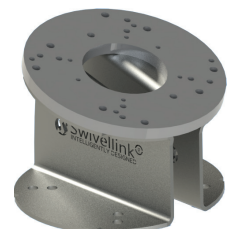

RB-15ADAPTER-CB200

COBOT Mobile Cart



RB-MTC-CB300



RB-MTC-CB300-15KIT
Includes RB-PFT-15BASE-KIT

Both carts include:

- ✓ Table weldment with top plate/COBOT adapter plate
- ✓ 4 casters
- ✓ 4 leveling feet
- ✓ Same hole pattern as CB200 Series COBOT pedestal

Other Accessories

Wings

Fold-down wing
for left side
RB-MTC-LEFTWING



Fold-down wing
for right side
RB-MTC-RIGHTWING

Toolbox



RB-MTC-TOOLBOX

Caster



RB-MTC-CASTER1

Leveling Foot

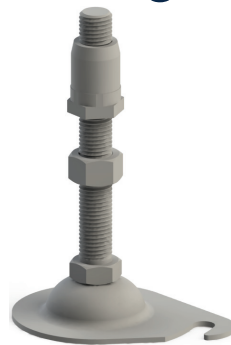

RB-MTC-FOOT

15° Base Kit

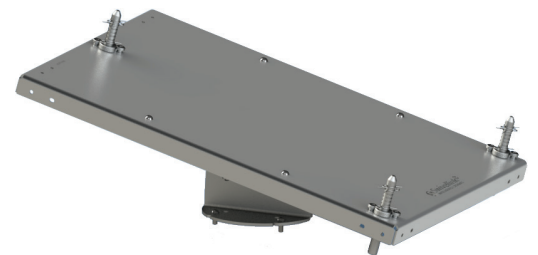

RB-PFT-15BASE-KIT

Contact your Distributor
for More Information