

# Bernoulli Gripper

ø40, ø60

New

For the adsorption transfer of thin cloths, films, printed circuit boards, etc.

Energy saving

Max. **72%** reduction<sup>\*1</sup>

<sup>\*1</sup> Comparison of air consumption to lifting force

High lifting force

**28.3 N**

5.7 times that of the existing model

(Existing model: 5.0 N → ZNC60: 28.3 N)



ZNC40  
Body material: Resin  
30 g



Scan here for applications.

## 3 types of body materials



## With stopper

Prevents workpiece slippage



## With vibration suppression cover

Vibration noise:

Max. **17 dB[A]** reduction

Suppresses the vibration noise of thin workpieces



**ZNC Series**



CAT.ES100-145A

## Basic type (Without vibration suppression cover/stopper)

**When a flat, hard, non-breathable workpiece such as glass is adsorbed, it will be gripped without direct contact.**

As the gripper approaches the workpiece, the flow speed of the air flowing between the gripper and the workpiece increases, creating a vacuum and adsorbing the workpiece. In the case of a flat, hard, non-breathable workpiece such as glass, it will be in a non-contact state. The lifting force of the gripper and the weight of the workpiece is balanced around 0.2 to 0.5 mm.

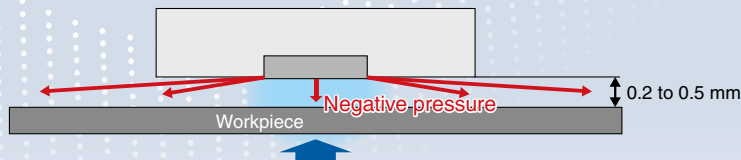

## With stopper

**The rubber stopper prevents the workpiece from sliding.**

By attaching stoppers, the state changes from non-contact to contact and the workpiece is gripped. For flat and hard workpieces such as glass, it is recommended to have stoppers to prevent slipping. When using a soft workpiece such as cloth or paper, it may come into contact with the gripper and generate vibration noise. In this case, it is recommended to have a vibration suppression cover.

- \* Only the rubbers of the stopper can be replaced.
- \* The stopper reduces the lifting force.

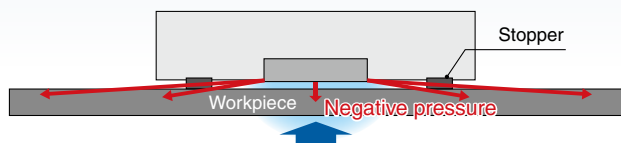

## With vibration suppression cover

**Suppresses the vibration that occurs when a soft workpiece such as cloth or paper is adsorbed**

The vibration suppression cover suppresses the vibration generated when a soft workpiece, such as cloth or paper, comes into contact with the gripper, and reduce the generation of sound. Air flows at high speed in the gap between the vibration suppression cover and the workpiece, enabling stable suction transfer.

- \* With the vibration suppression cover, the status is changed to contact instead of non-contact.
- \* The vibration suppression cover reduces the lifting force.

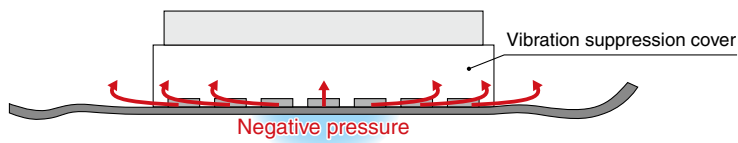

### Application Examples

For the adsorption of printed circuit boards

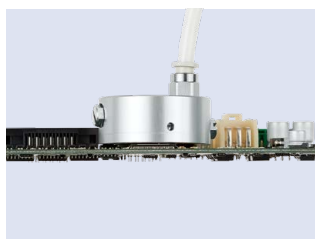

For the adsorption of bubble wrap



For the adsorption of thin cloths



For the adsorption of paper

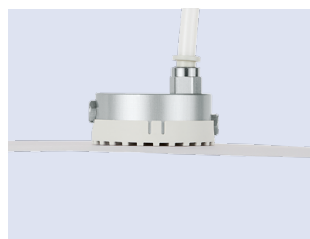

# Construction and working principle

Clean air is discarded from the inside to the outside. There is no clogging of foreign matter.

**Bernoulli gripper construction**

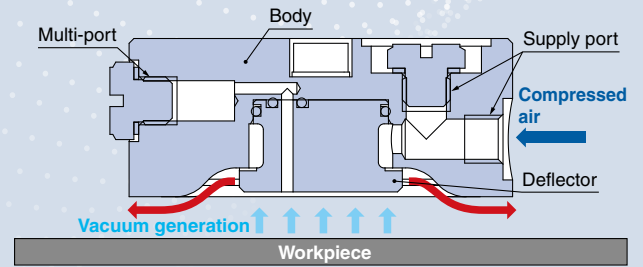

## Piping port

### Multiple ports

Can be used as a sensor port or release port

**Release port**

Workpieces can be removed easily.

Release air OUT

Release air IN

**A pressure sensor option can be selected.**

Detects the presence of a workpiece  
\* Connects to the multi-port



Body material: **Aluminum**

### Air supply port

Piping from the top and side is possible.

**Requires no piping**

Direct porting is possible.

\* The O-ring should be provided by the customer.

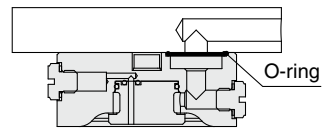

Body material: **Stainless steel**

Anti-corrosive type



Body material: **Resin**

Lightweight type

## Series Variations

Material	Size	Weight [g]	Attachment		Pressure sensor			
			With stopper	With vibration suppression cover				
				Resin		Stainless steel		
Aluminum	40	48	NBR (Improved abrasion resistance)	●	●	With or without		
	60	110		—	●			
Resin	40	30		Silicone rubber (Heat/ozone resistant)	●		—	
	60	67			—		●	
Stainless steel	40	139					—	●
	60	323					—	●

# ZNC Series Model Selection

## Selection Procedure

### [Basic type]

#### Step 1 Calculate the lifting force.

$$W = M \times g \times t \times \frac{1}{n}$$

**W**: Required lifting force [N]

**M**: Workpiece mass [kg]

**g**: Gravitational acceleration [= 9.8 m/s<sup>2</sup>]

**t**: Safety factor (Recommended value: 2 or more)

**n**: Number of Bernoulli grippers [pcs.]

#### Selection example

Workpiece mass: **M** = 0.7 kg

Safety factor: **t** = 2

Number of Bernoulli grippers: **n** = 2 pcs.

Required lifting force: **W** =  $0.7 \times 9.8 \times 2 \times \frac{1}{2} = 6.9 \text{ N}$

#### Basic type

Workpiece: Smooth and non-permeable

Operating pressure: 0.3 MPa

Per lifting force graph for supply pressure

Lifting force of the **ZNC40** > Required lifting force

#### Step 2 Model selection

##### Lifting Force (ZNC40)

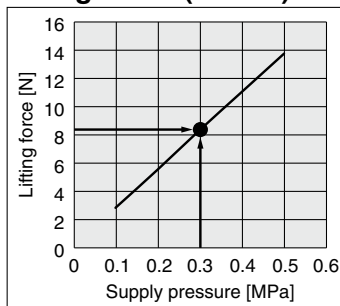

The lifting force changes depending on the shape, size, surface unevenness, breathability, flexibility, etc., of the workpiece. Use the selection result as a reference value and perform verification and confirmation on the actual machine.

### [With stopper/vibration suppression cover]

#### Step 1 Calculate the lifting force.

$$W = M \times g \times t \times \frac{1}{n}$$

**W**: Required lifting force [N]

**M**: Workpiece mass [kg]

**g**: Gravitational acceleration [= 9.8 m/s<sup>2</sup>]

**t**: Safety factor (Recommended value: 2 or more)

**n**: Number of Bernoulli grippers [pcs.]

#### Selection example

Workpiece mass: **M** = 0.25 kg

Safety factor: **t** = 2

Number of Bernoulli grippers: **n** = 1 pc.

Required lifting force: **W** =  $0.25 \times 9.8 \times 2 \times \frac{1}{1} = 4.9 \text{ N}$

#### With stopper

Workpiece: Smooth and non-permeable

Operating pressure: 0.4 MPa

Per lifting force graph for the distance to the workpiece

With stopper: Lifting force is checked at 1 mm.

(With vibration suppression cover: Lifting force is checked at 1.5 mm.)

Lifting force of the **ZNC40** > Required lifting force

#### Step 2 Model selection

##### Lifting Force–Distance from the Workpiece (ZNC40)

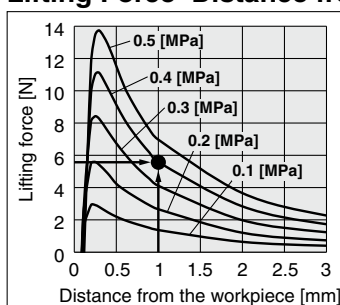

The lifting force changes depending on the shape, size, surface unevenness, breathability, flexibility, etc., of the workpiece. Use the selection result as a reference value and perform verification and confirmation on the actual machine.

# Bernoulli Gripper ZNC Series

## How to Order



ZNC **40**    -      

1  
 2  
 3  
 4

### 1 Body size

<b>40</b>	ø40 mm
<b>60</b>	ø60 mm

### 2 Body material



<b>Nil</b>	Aluminum	
<b>P</b>	Resin	
<b>S</b>	Stainless steel	

### 3 Attachment

<b>Nil</b>	Basic type (Without attachment)	
<b>PN</b>	With stopper	NBR (Black)
<b>PS</b>		Silicone rubber (White)
<b>VP</b>	With vibration suppression cover*1	Resin
<b>VS</b>		Stainless steel



### 4 Pressure sensor

<b>Nil</b>	None	
<b>S</b>	With pressure sensor Part no.: <b>PSE541-M5-X2</b>	

\* The pressure sensor is shipped together with the product but does not come assembled.

- \*1 Refer to the Table 1. With Vibration Suppression Cover for the size and material.
- \* Stopper cannot be added afterward.
- \* Vibration suppression cover can be added to the basic type afterward.
- \* The stopper and vibration suppression cover cannot be used together.

**Table 1. With Vibration Suppression Cover**

Symbol	Material	Body size symbol	Body material		
			Aluminum	Resin	Stainless steel
<b>VP</b>	Resin	40	●	●	—
		60	—	—	—
<b>VS</b>	Stainless steel	40	●	—	●
		60	●	●	●

## Attachments/Part Nos.

### Stopper

ZNCM-**PS** 2

\* With 3 stoppers and 3 spring pins  
For replacement instructions ⇨ Refer to page 10.

#### Material

<b>PN</b>	NBR (Black)
<b>PS</b>	Silicone rubber (White)

### Vibration suppression cover

ZNCM-**40** **VP**

\* With 3 mounting screws for stainless steel

#### Body size

<b>40</b>	ø40 mm
<b>60</b>	ø60 mm

#### Material

<b>VP</b>	Resin
<b>VS</b>	Stainless steel



# ZNC Series



## Specifications

Model		ZNC40	ZNC60	
Lifting force [N]*1		13.8	28.3	
Air consumption [L/min] (ANR)*2		182	182	
Type		Bernoulli		
Fluid		Air		
Operating pressure		0.1 to 0.5 MPa		
Proof pressure		0.75 MPa		
Ambient and operating temperatures*3	Body material	Aluminum	-5 to 80°C (0 to 50°C)	
		Resin	-5 to 40°C (0 to 40°C)	
		Stainless steel	-5 to 80°C (0 to 50°C)	
Grease		Grease-free		
Weight [g]*4	Body material	Aluminum	48	110
		Resin	30	67
		Stainless steel	139	323
Pressure sensor*5		PSE541-M5-X2 (Grease-free) Rated pressure range: 0 to -101 kPa		

\*1 Lifting force of the basic type for max. supply pressure. Values when a flat and non-breathable workpiece is adsorbed

\*2 Air consumption for max. supply pressure

\*3 No freezing or condensation. The values in ( ) are for models with a pressure sensor.

\*4 Weight for the basic type without a plug

\*5 For pressure sensor details, refer to the PSE540 series in the **Web Catalog** and the Operation Manual.

## ZNC40□

### Lifting Force

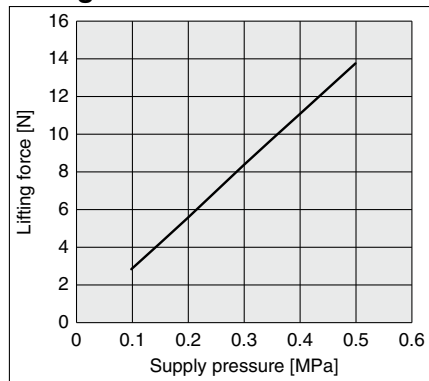

### Consumption Flow Rate

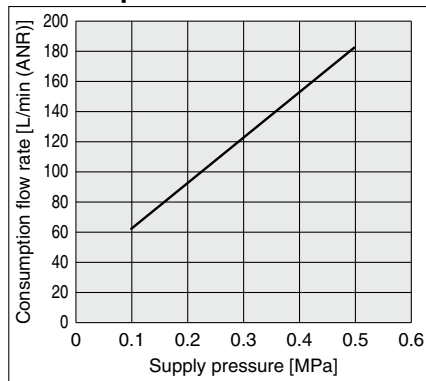

### Lifting Force–Distance from the Workpiece

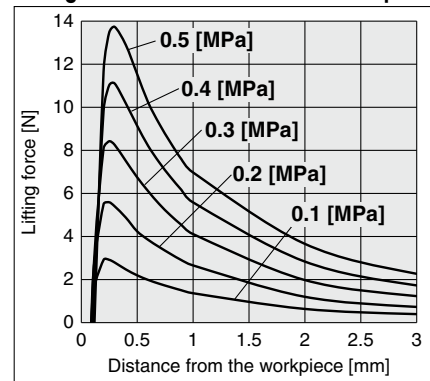

## ZNC60□

### Lifting Force

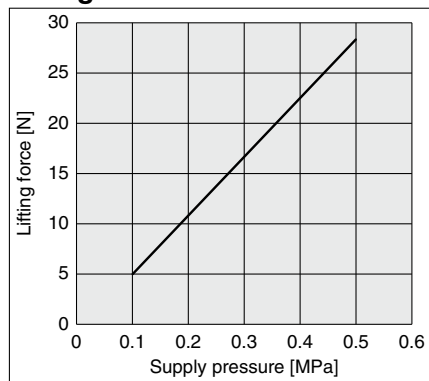

### Consumption Flow Rate

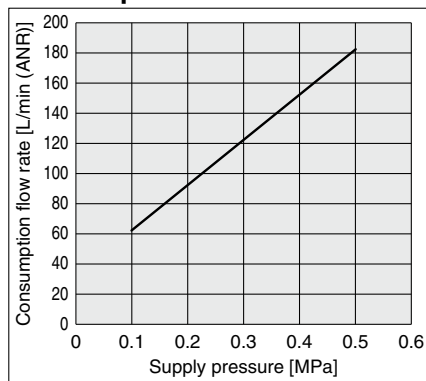

### Lifting Force–Distance from the Workpiece

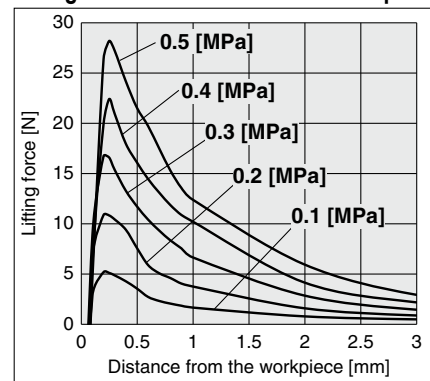

## Construction

Basic type

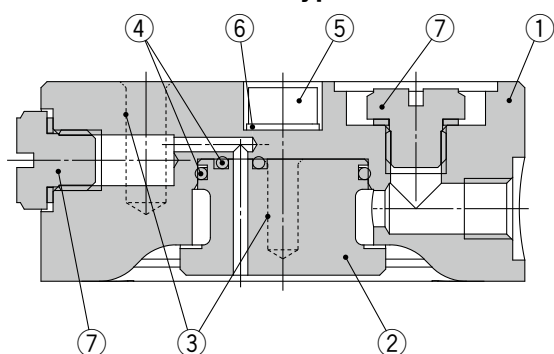

With vibration suppression cover: Resin

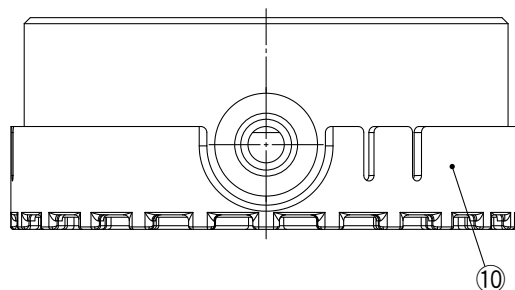

With stopper

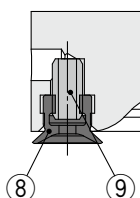

With vibration suppression cover: Stainless steel

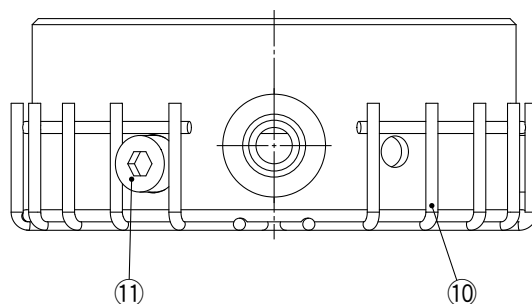

## Component Parts

No.	Description	Material (Surface treatment)	Note	
1	Body	Aluminum alloy (Anodized)	Body material	For aluminum
		Synthetic resin	Body material	For resin
		Stainless steel	Body material	For stainless steel
2	Deflector	Aluminum alloy (Anodized)	Body material	For aluminum
		Synthetic resin	Body material	For resin
		Stainless steel	Body material	For stainless steel
3	Helical insert	Stainless steel	Body material	For resin
4	O-ring	FKM		
5	Hexagon socket head cap screw	Stainless steel		
6	Flat washer	Stainless steel		
7	Plug	Stainless steel/FKM		
8	Stopper	NBR	With stopper	Refer to page 4 for part numbers.
		Silicone rubber*1, *2		
9	Spring pin	Stainless steel	With vibration suppression cover	
10	Vibration suppression cover	Synthetic resin		
		Stainless steel		
11	Hexagon socket head cap screw	Stainless steel		

\*1 Compliant with the FDA's (U.S. Food and Drug Administration) 21CFR§177.2600 dissolution test

\*2 Compliant with the standards for "Rubber apparatus (excluding baby drinking apparatus) and containers/packaging" (D3) (Partial revision: Japanese Ministry of Health, Labour, and Welfare Notification No. 595, 2012) in Section 3 "Apparatus and Containers/Packaging" of the Food Sanitation Act, Article 18 "Specifications and Standards for Food and Food Additives, etc." (Japanese Ministry of Health and Welfare Notification No. 370, 1959)

# ZNC Series

## Dimensions

### Basic type

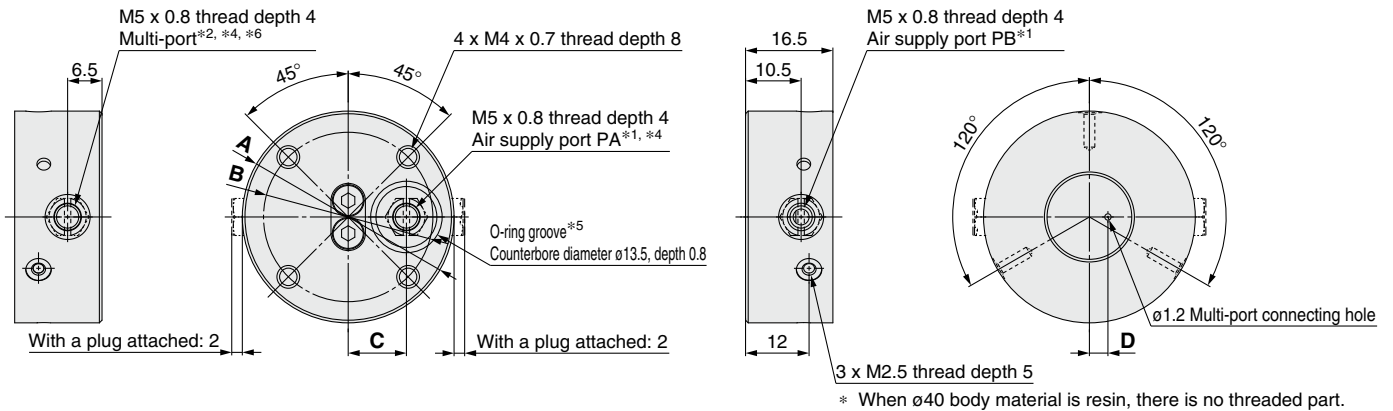

### With stopper

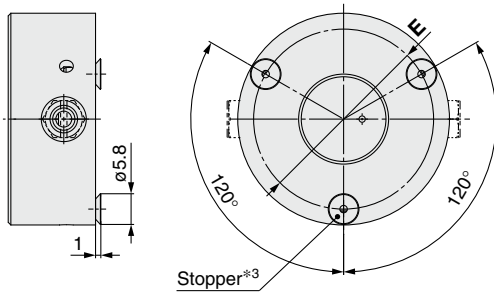

### With vibration suppression cover

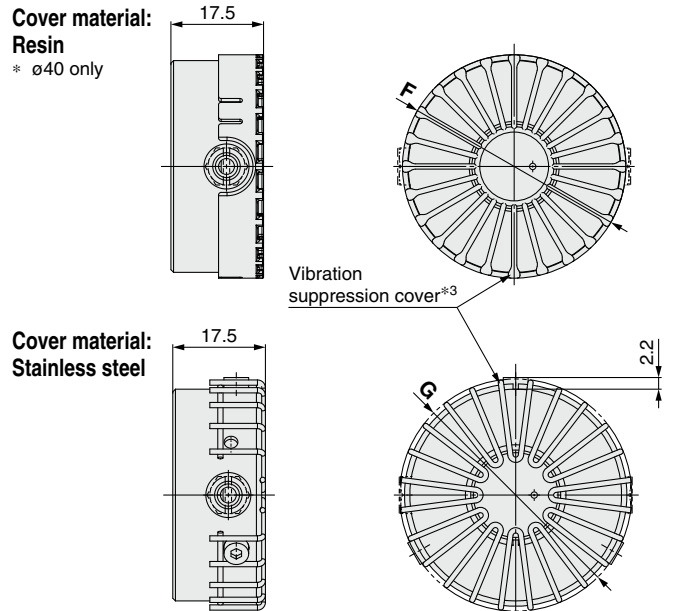

- \*1 Supply air to either air supply port PA or PB. Seal the unused ports with plugs.
- \*2 Seal the multi-port with a plug when not in use.
- \*3 The stopper and cover cannot be used together.
- \*4 The product is shipped with plugs in the air supply port PA and multi-port.  
After determining which port to use, it is recommended to apply adhesive to the threads of the two air supply ports and the multi-port.
- \*5 The O-ring is not included. Attach an O-ring (13.5 x 11.5 x 1) if necessary.

- \*6 Use the multi-port as a sensor mounting or release port.
- \* For pressure sensor details, refer to the PSE540 series in the **Web Catalog** and the Operation Manual.
- \* The pressure sensor is shipped together with the product but does not come assembled.

## Dimensions

Model										[mm]
ZNC	Outer body dia.	Body material	A	B	C	D	E	F	G	Weight [g]*1
	40	40	Nil	40	32	11	3.5	34	42.2	44
P			30							
S			139							
60	60	Nil	60	47	21	10	54	—	64	110
		P								67
		S								323

\*1 The stopper, vibration suppression cover, and plug weights are not included.





# ZNC Series

## Specific Product Precautions 1

Be sure to read this before handling the products.

### Design / Selection

- In the Bernoulli gripper, air flows between the suction surface and the workpiece when the workpiece is adsorbed. The workpiece is then gripped without direct contact, making it easy to slide sideways. Consider an external guide, etc., for safety design.**

The workpiece may fall due to the influence of external force or inertial force during workpiece transportation. This can cause injury or damage the equipment.

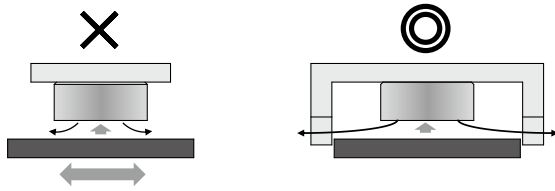

No restraining force in the horizontal direction

Restrain horizontal movement with a guide.

- The product performance of the Bernoulli gripper varies greatly depending on the type of workpiece. Please make your selection carefully.**

The lifting force changes depending on the shape, size, surface unevenness, breathability, flexibility, etc., of the workpiece.

- Select the Bernoulli gripper with sufficient margin for acceleration/deceleration, vibration, shock, and wind pressure during workpiece transportation.**

Ensure a safety factor for the allowable lifting force. The recommended value is 2 or more. If necessary, reduce external force and install a wind pressure prevention cover to design a safe application.

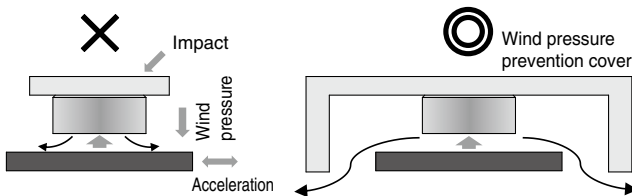

- When adjusting the distance between the Bernoulli gripper and the workpiece, design your application taking the performance characteristics for the distance into consideration.**

The lifting force changes depending on the distance from the workpiece.

- When adsorbing food, take sufficient safety measures. Additionally, please contact us in advance.**

- The product performance described in the catalog is based on the condition that the workpiece is larger than the product suction surface, and the workpiece is smooth and non-breathable.**

If the workpiece is smaller than the product suction surface, the lifting force may be reduced or it may not be possible to lift. Please check with customer's equipment before use.

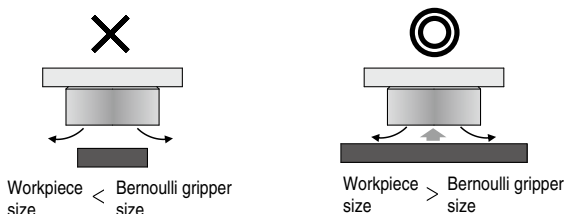

Workpiece size < Bernoulli gripper size

Workpiece size > Bernoulli gripper size

### Mounting

- Be careful not to drop or hit the product to avoid scratches and dents.**

Even slight deformation of the suction surface can decrease product performance.

- When installing the product, tighten it with an appropriate tightening torque.**

If excessive or insufficient tightening torque is applied, sealing failure or loose screws may result. Adhesive is recommended for screws.

#### Body Mounting

Model	Body material	Screw size	Thread length [mm]	Tightening torque [N·m]
ZNC40	Aluminum	M4 x 0.7	8	1.5
ZNC40P	Resin			0.76
ZNC40S	Stainless steel			1.5
ZNC60	Aluminum			1.5
ZNC60P	Resin			0.76
ZNC60S	Stainless steel			1.5

- When installing the stainless steel vibration suppression cover, tighten it with the proper tightening torque.**

If excessive or insufficient tightening torque is applied, loose screws may result. Adhesive is recommended for screws.

#### Vibration Suppression Cover Mounting (Stainless steel type only)

Model	Body material	Screw size	Thread length [mm]	Tightening torque [N·m]
ZNC40	Aluminum	M2.5 x 0.45	5	0.36
ZNC40P	Resin			0.18
ZNC40S	Stainless steel			0.36
ZNC60	Aluminum			0.36
ZNC60P	Resin			0.18
ZNC60S	Stainless steel			0.36

- When installing tube fitting (supply port), pressure sensor (multi-port), and plugs, tighten them with an appropriate tightening torque. Retighten all bolts regularly.**

If excessive or insufficient tightening torque is applied, loose screws may result. Loose bolts may cause air leakage or falling of parts. Retighten them regularly and apply adhesive.

#### Supply Port

Model	Body material	Screw size	Thread length [mm]	Tightening torque [N·m]
ZNC40	Aluminum	M5 x 0.8	4	1 to 1.5
ZNC40P	Resin			0.5 to 1
ZNC40S	Stainless steel			1 to 1.5
ZNC60	Aluminum			1 to 1.5
ZNC60P	Resin			0.5 to 1
ZNC60S	Stainless steel			1 to 1.5



# ZNC Series Specific Product Precautions 2

Be sure to read this before handling the products.

## Mounting

5. When mounting the product directly without piping, smooth the mounting surface and use an appropriate O-ring. (The O-ring should be provided by the customer.)

Installation on a mounting surface with a rough surface, scratches or dents, or mounting an unsuitable O-ring may cause sealing failure.

### Recommended O-ring

Model	Size
ZNC40□	13.5 x 11.5 x 1
ZNC60□	

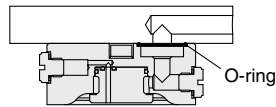

## Air Supply

1. Use compressed air and control the cleanliness.

Install an air filter, air dryer, or a mist separator. A system with a quality grade of No. C or higher in the air preparation equipment model selection guide of Best Pneumatics No. 6 is recommended.

## Handling

1. Depending on the use conditions, the workpiece may come into contact with the main body at the moment of suction even if it is a basic body type. If the product with stopper or with vibration suppression cover is used, it will come into contact with the workpiece.

2. The NBR stopper is not suitable for an ozone environment, so select silicone rubber.

Deterioration is accelerated in ozone environments such as in clean rooms, around ionizers or motor equipment.

3. The stopper and vibration suppression cover cannot be used together.

4. If a thin and soft workpiece is adsorbed, a high frequency sound may be produced. This generation of sound is due to the vibration of the workpiece, and is not a product abnormality.

Sound generation may be reduced by reducing the supply pressure or using the vibration suppression cover type.

5. Depending on the type of workpiece and usage conditions, the pressure sensor may not be able to detect the workpiece or the sensor value may differ.

The vacuum pressure changes depending on the type of workpiece and the conditions of use. Please verify the product with the actual machine before actual operation.

## Handling

6. When arranging the Bernoulli grippers, consider the position of the center of gravity of the workpiece to maintain balance.

If the mounting position of the product and the position of the center of gravity of the workpiece are misaligned, the rotational force acts due to the weight of the workpiece, which may cause it to come off.

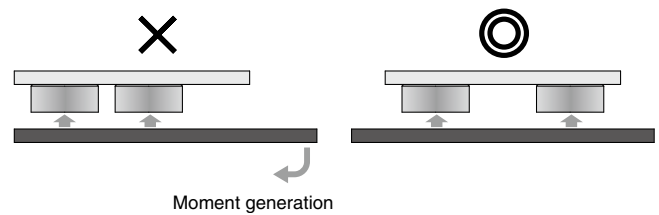

7. When installing the vibration suppression cover (synthetic resin), align the center position of the product name plate and the SMC logo of the vibration suppressor.

If the mounting position is not correct, the vibration suppression cover may interfere with the fittings, etc., resulting in deterioration of product performance and damage to the cover.

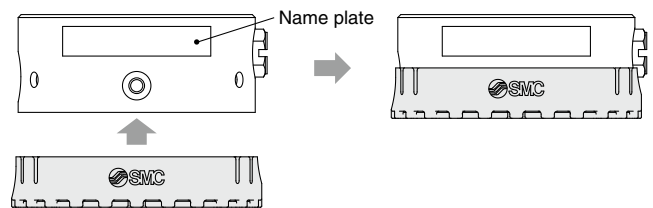

8. Stopper cannot be added afterward.

Since the body shape of the basic type and the stopper type are different, it is not possible to add a stopper to the basic type. If you order the stopper type and then remove the stopper to use it as the basic type, the lifting force will be lower than the basic type.

The vibration suppression cover can be added to the basic type afterward.

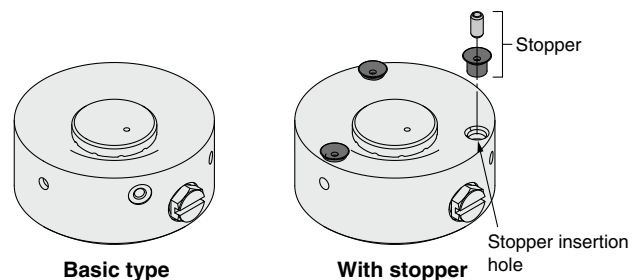



## ZNC Series

# Specific Product Precautions 3

Be sure to read this before handling the products.

### Maintenance

#### 1. Do not disassemble or modify the body of the product.

If the disassembled and/or modified, the functions and performance may not be achieved and the product will not be warranted.

#### 2. In periodical inspections, check the following items and replace the parts if necessary.

- Scratches, gouges, abrasion, corrosion
- Air leakage (Retighten the fitting and plugs.)
- Twisting, crushing, and turning of connected tubes
- Hardening, deterioration, and softening of connected tubes
- Cracks, wear, and deformation of the stopper

#### 3. Replacement of the stopper

If the stopper is not mounted correctly, the product performance may deteriorate and the stopper may be damaged.

1

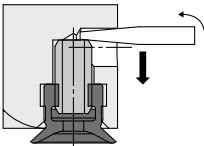

Use a precision screwdriver to push the spring pin out of the side hole in the body and remove the spring pin and stopper.

2

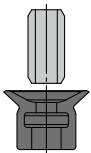

Insert the spring pin to a new stopper.

3

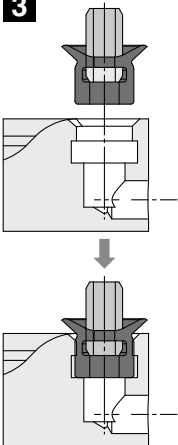

Insert the new stopper with a spring pin to the body.\*1

\*1 Apply alcohol for easier insertion.

4

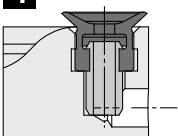



Insert the spring pin to the end.

## Safety Instructions

These safety instructions are intended to prevent hazardous situations and/or equipment damage. These instructions indicate the level of potential hazard with the labels of “**Caution**,” “**Warning**” or “**Danger**.” They are all important notes for safety and must be followed in addition to International Standards (ISO/IEC)\*1), and other safety regulations.

 **Caution:** **Caution** indicates a hazard with a low level of risk which, if not avoided, could result in minor or moderate injury.

 **Warning:** **Warning** indicates a hazard with a medium level of risk which, if not avoided, could result in death or serious injury.

 **Danger:** **Danger** indicates a hazard with a high level of risk which, if not avoided, will result in death or serious injury.

\*1) ISO 4414: Pneumatic fluid power – General rules relating to systems.  
ISO 4413: Hydraulic fluid power – General rules relating to systems.  
IEC 60204-1: Safety of machinery – Electrical equipment of machines.  
(Part 1: General requirements)  
ISO 10218-1: Manipulating industrial robots – Safety.  
etc.

### Warning

#### 1. The compatibility of the product is the responsibility of the person who designs the equipment or decides its specifications.

Since the product specified here is used under various operating conditions, its compatibility with specific equipment must be decided by the person who designs the equipment or decides its specifications based on necessary analysis and test results. The expected performance and safety assurance of the equipment will be the responsibility of the person who has determined its compatibility with the product. This person should also continuously review all specifications of the product referring to its latest catalog information, with a view to giving due consideration to any possibility of equipment failure when configuring the equipment.

#### 2. Only personnel with appropriate training should operate machinery and equipment.

The product specified here may become unsafe if handled incorrectly. The assembly, operation and maintenance of machines or equipment including our products must be performed by an operator who is appropriately trained and experienced.

#### 3. Do not service or attempt to remove product and machinery/equipment until safety is confirmed.

1. The inspection and maintenance of machinery/equipment should only be performed after measures to prevent falling or runaway of the driven objects have been confirmed.
2. When the product is to be removed, confirm that the safety measures as mentioned above are implemented and the power from any appropriate source is cut, and read and understand the specific product precautions of all relevant products carefully.
3. Before machinery/equipment is restarted, take measures to prevent unexpected operation and malfunction.

#### 4. Contact SMC beforehand and take special consideration of safety measures if the product is to be used in any of the following conditions.

1. Conditions and environments outside of the given specifications, or use outdoors or in a place exposed to direct sunlight.
2. Installation on equipment in conjunction with atomic energy, railways, air navigation, space, shipping, vehicles, military, medical treatment, combustion and recreation, or equipment in contact with food and beverages, emergency stop circuits, clutch and brake circuits in press applications, safety equipment or other applications unsuitable for the standard specifications described in the product catalog.
3. An application which could have negative effects on people, property, or animals requiring special safety analysis.
4. Use in an interlock circuit, which requires the provision of double interlock for possible failure by using a mechanical protective function, and periodical checks to confirm proper operation.

### Caution

#### 1. The product is provided for use in manufacturing industries.

The product herein described is basically provided for peaceful use in manufacturing industries.  
If considering using the product in other industries, consult SMC beforehand and exchange specifications or a contract if necessary.  
If anything is unclear, contact your nearest sales branch.

### Limited warranty and Disclaimer/ Compliance Requirements

The product used is subject to the following “Limited warranty and Disclaimer” and “Compliance Requirements”.

Read and accept them before using the product.

#### Limited warranty and Disclaimer

1. The warranty period of the product is 1 year in service or 1.5 years after the product is delivered, whichever is first.\*2)  
Also, the product may have specified durability, running distance or replacement parts. Please consult your nearest sales branch.
2. For any failure or damage reported within the warranty period which is clearly our responsibility, a replacement product or necessary parts will be provided.  
This limited warranty applies only to our product independently, and not to any other damage incurred due to the failure of the product.
3. Prior to using SMC products, please read and understand the warranty terms and disclaimers noted in the specified catalog for the particular products.

##### \*2) Vacuum pads are excluded from this 1 year warranty.

A vacuum pad is a consumable part, so it is warranted for a year after it is delivered.  
Also, even within the warranty period, the wear of a product due to the use of the vacuum pad or failure due to the deterioration of rubber material are not covered by the limited warranty.

#### Compliance Requirements

1. The use of SMC products with production equipment for the manufacture of weapons of mass destruction (WMD) or any other weapon is strictly prohibited.
2. The exports of SMC products or technology from one country to another are governed by the relevant security laws and regulations of the countries involved in the transaction. Prior to the shipment of a SMC product to another country, assure that all local rules governing that export are known and followed.

### Caution

#### SMC products are not intended for use as instruments for legal metrology.

Measurement instruments that SMC manufactures or sells have not been qualified by type approval tests relevant to the metrology (measurement) laws of each country. Therefore, SMC products cannot be used for business or certification ordained by the metrology (measurement) laws of each country.

## Safety Instructions

Be sure to read the “Handling Precautions for SMC Products” (M-E03-3) and “Operation Manual” before use.