

Stainless Steel 316 Fittings

Series *KQG2*

Compact and Light

RoHS

Dimensions **Approx. 30%** Shorter
* KQG2L06-01S

Weight **Approx. 62%** Lighter
* KQG2L06-01S

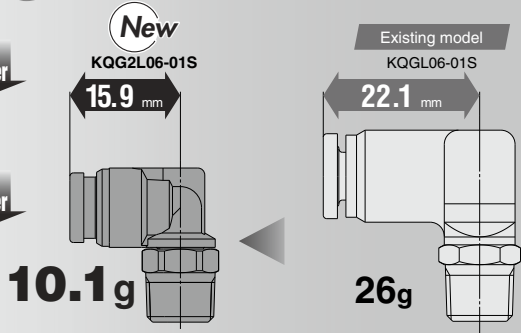

- More configuration variations
17 models ◀ **9 models**
- Tubing size:
Ø3.2 and Ø16 have been added.

Material

Stainless steel 316

Seal parts: Special FKM

Fluid temperature

-5 to 150°C

Applicable tubing

Metric size, Inch size

Connection thread

M, R, Rc, UNF, NPT

○ Grease-free/Can be used with steam.

○ Certified to meet current Food Sanitation Law standards.

(Component materials have met apparatuses and container-packages standards.)

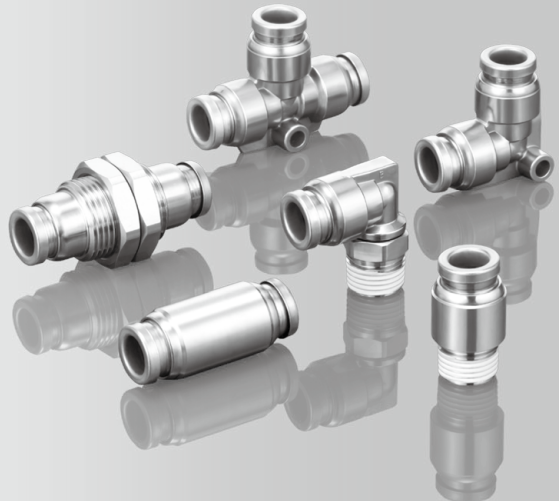

KQ2

KQB2

KS
KX

KM

KF

M

H/DL
L/LL

KC

KK

KK130

DM

KDM

KB

KR

KA

KQG2

KG

KFG2

MS

KKA

KP

LQ

MQR

T

Stainless Steel 316 One-touch Fittings Series KQG2

Compact and light

Dimensions: Approx. **30%** shorter

Weight: Approx. **62%** lighter

* Comparison with KQGL06-01S

More configuration variations

17 models < **9** models

More tubing sizes added

Ø3.2 and Ø16 have been added.

Material

Metal parts: **Stainless steel 316**

Seal parts: **Special FKM**

Applicable tubing material

FEP • PFA • Nylon • Soft nylon
Polyurethane • Polyolefin

Fluid temperature: -5 to 150°C

Grease-free

Can be used with steam.

New

KQG2L06-01S

15.9 mm

Weight
10.1 g

Existing model

KQGL06-01S

22.1 mm

Weight
26 g

All Stainless steel 316 except seal parts

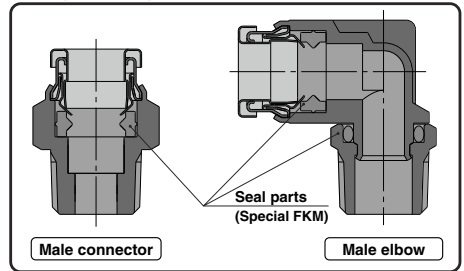

Applicable tubing	Connection thread	Page
Metric size	M, R, Rc	P.242 to 247
Inch size	UNF, NPT	P.248 to 253



Conventional model

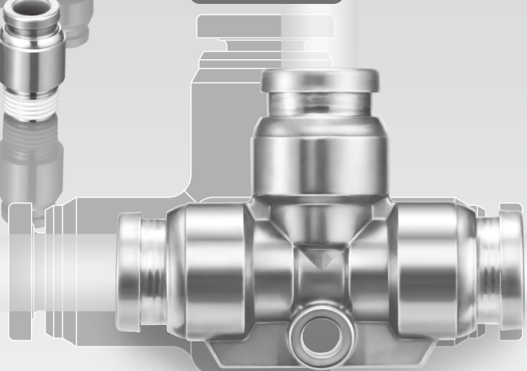

Certified to meet current
Food Sanitation Law standards.
(Component materials have
met apparatuses and container-
packages standards.)

Stainless Steel 316 One-touch Fittings *Series KQG2*

Variations

Male Connector **KQG2H**



MetricP. 243
InchP. 249

Hexagon Socket Head Male Connector **KQG2S**



MetricP. 243
InchP. 249

Straight Union **KQG2H**



MetricP. 243
InchP. 249

Male Elbow **KQG2L**



MetricP. 244
InchP. 250

Male Branch Tee **KQG2T**



MetricP. 244
InchP. 250

Union Elbow **KQG2L**



MetricP. 244
InchP. 250

Bulkhead Union **KQG2E**



MetricP. 245
InchP. 251

Union Tee **KQG2T**



MetricP. 245
InchP. 251

Union "Y" **KQG2U**



MetricP. 245
InchP. 251

Different Diameter Tee **KQG2T**



MetricP. 245
InchP. 251

Plug-in Reducer **KQG2R**



MetricP. 245
InchP. 251

Different Diameter Straight **KQG2H**



MetricP. 246
InchP. 252

Different Diameter Union "Y" **KQG2U**



MetricP. 246
InchP. 252

Bulkhead Connector **KQG2E**



MetricP. 246
InchP. 252

Extended Male Elbow **KQG2W**



MetricP. 247
InchP. 252

Female Connector **KQG2F**



MetricP. 247
InchP. 253

Plug **KQG2P**



MetricP. 247
InchP. 253

KQ2

KQB2

KS
KX

KM

KF

M

H/DL
L/LL

KC

KK

KK130

DM

KDM

KB

KR

KA

KQG2

KG

KFG2

MS

KKA

KP

LQ

MQR

T

Stainless Steel 316 One-touch Fittings

Applicable Tubing: Metric Size, Connection Thread: M, R, Rc

Series **KQG2**

RoHS



Applicable Tubing

Tubing material	FEP, PFA, Nylon, Soft nylon ^{Note 1)} , Polyurethane, Polyolefin
Tubing O.D.	ø3.2, ø4, ø6, ø8, ø10, ø12, ø16

Specifications

Fluid	Air, Water, Steam ^{Note 2)}
Operating pressure range ^{Note 3)}	-100 kPa to 1 MPa ^{Note 4)}
Proof pressure	3.0 MPa
Ambient and fluid temperature ^{Note 5)}	-5 to 150°C (No freezing) ^{Note 4)}
Lubricant	Grease-free specification
Seal on the threads	With sealant

Note 1) For soft nylon tubing, water cannot be used.

Note 2) Consult with SMC regarding applicable tube separately.

Note 3) Avoid using in a vacuum holding application such as a leak tester, since there is leakage.

Note 4) Check the operating pressure range and operating temperature range of the tubing.

Note 5) It is recommended that you use the inner sleeve in the following conditions (Except ø3.2):

- When using in an environment where the fluid temperature changes drastically.
- When using at a high temperature.

* Temperature Condition of Mounting the Inner Sleeve

Tubing	Temperature
FEP tubing/Series TH	80°C or more
Super PFA tubing/Series TL	120°C or more

Spare Parts

Description	Tubing O.D.	Part no.	Material
Gasket	—	M-5G3	Stainless steel 316, Special FKM
Bulkhead nut	ø3.2, ø4	KQG223-P01	Stainless steel 316
	ø6	KQG206-P01	
	ø8	KQG208-P01	
	ø10	KQG210-P01	
	ø12	KQG212-P01	
	ø16	KQG216-P01	

Cross Reference Table of the Inner Sleeve

Tubing O.D.	Tubing material			Applicable inner sleeve	
	TUS (Soft polyurethane)	TH/TH (FEP)	TL/TIL (Super PFA)	Part no.	Length
ø4	—	TH0402	—	TJG-0402	18
	TUS0425	TH0425	—	TJG-0425	18
ø6	—	—	TL0403	TJG-0403	18
	TUS0604	TH0604	TL0604	TJG-0604	19
ø8	TUS0805	—	—	TJG-0805	20.5
	—	TH0806	TL0806	TJG-0806	20.5
ø10	TUS1065	—	—	TJG-1065	23
	—	TH1075	—	TJG-1075	23
	—	TH1008	TL1008	TJG-1008	23
ø12	TUS1208	—	—	TJG-1208	24
	—	TH1209	—	TJG-1209	24
	—	TH1210	TL1210	TJG-1210	24

* Stainless steel 316 is used for the TJG series.

Construction

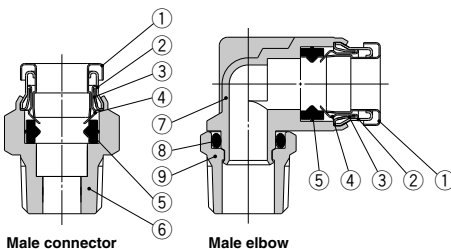

Component Parts

No.	Description	Material
1	Release button	Stainless steel 316
2	Guide 1	Stainless steel 316
3	Guide 2	Stainless steel 316
4	Chuck	Stainless steel 316
5	Seal	Special FKM (Fluoro coated)
6	Male connector body	Stainless steel 316
7	Male elbow body	Stainless steel 316
8	O-ring	Special FKM (Fluoro coated)
9	Stud	Stainless steel 316

Stainless Steel 316 One-touch Fittings *Series KQG2*

Applicable Tubing: Metric Size, Connection Thread: M, R, Rc

Dimensions

Male Connector: KQG2H



Applicable tubing O.D. (mm)	Connection thread R, M	Model	H (Width across flat)	Note 1) ϕD	L	A*	M	Note 2) Effective area (mm ²)	Weight (g)	
$\phi 3.2$	M5 x 0.8	KQG2H23-M5	8	8	16.5	13.5	12	3	3.3	
	1/8	KQG2H23-01S	10		15.4	12.3		3.4	5.7	
	1/4	KQG2H23-02S	14		21	16.3		16.9		
$\phi 4$	M5 x 0.8	KQG2H04-M5	8	8.7	17.1	14.1	12.6	4	5	
	1/8	KQG2H04-01S	10		15.3	12.2		5.6	4.7	
	1/4	KQG2H04-02S	14		20.9	16.2		15.8		
$\phi 6$	M5 x 0.8	KQG2H06-M5	12	11.1	19.1	16.1	13.6	4	7.7	
	1/8	KQG2H06-01S	12		18.1	15		7		
	1/4	KQG2H06-02S	14		20.8	16.1		13.1	14.5	
	3/8	KQG2H06-03S	17		23	17.9		27.3		
	1/8	KQG2H08-01S	14		24.5	21.4		16.1	12.8	
$\phi 8$	1/4	KQG2H08-02S	14	13.4	22.3	17.6	16.1	26.1	12.9	
	3/8	KQG2H08-03S	17		23.7	18.6		24.7		
	1/8	KQG2H10-01S	12		25.5	22.4		26.1	18.9	
	1/4	KQG2H10-02S	17		27.9	23.2		41.5	21.6	
	3/8	KQG2H10-03S	22		23	17.9		20.6	20.6	
$\phi 10$	1/2	KQG2H10-04S	22	16.4	28.6	22.2	17		51.1	
	1/4	KQG2H12-02S	19		30.5	25.8		27.4		
	3/8	KQG2H12-03S	22		24.7	19.6		18.6	58.3	20.5
	1/2	KQG2H12-04S	22		28.7	22.3		44.6		
	3/8	KQG2H16-03S	24		33.6	28.5		20.8	81	46
$\phi 16$	1/2	KQG2H16-04S	24	24.6	29.5	23.1	20.8	113	37.4	

* Reference dimensions after installation of R thread
 Note 1) ϕD is maximum diameter.
 Note 2) Value of FEP tubing.
 Value of nylon tubing for $\phi 16$ only.

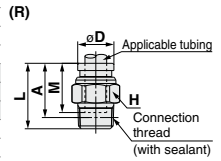
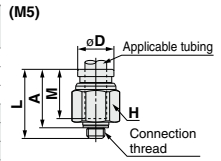

- KQ2
- KQB2
- KS
- KX
- KM
- KF
- M
- H/DL
- L/LL
- KC
- KK
- KK130
- DM
- KDM
- KB
- KR
- KA
- KQG2
- KG
- KFG2
- MS
- KKA
- KP
- LQ
- MQR
- T

Hexagon Socket Head Male Connector: KQG2S



Applicable tubing O.D. (mm)	Connection thread R, M	Model	H (Width across flat)	Note 1) ϕD	L	A*	M	Note 2) Effective area (mm ²)	Weight (g)
$\phi 3.2$	M5 x 0.8	KQG2S23-M5	2	9	16.5	13.5	12	3	3.8
	1/8	KQG2S04-01S	3	10	19.6	16.5	12.6	4.1	7.6
$\phi 4$	M5 x 0.8	KQG2S06-M5	2	12	19.6	16.6	13.6	4	7.4
	1/8	KQG2S06-01S	4		20.6	17.5		10	8.7
	1/4	KQG2S06-02S	4		14	20.6		15.9	10.7
$\phi 6$	1/8	KQG2S08-01S	5	14	24.7	21.6	16.1	17.2	12.3
	1/4	KQG2S08-02S	6		22.9	18.2		23.3	12.8
	3/8	KQG2S08-03S	6		17	23.1		18	22.8
$\phi 8$	1/8	KQG2S10-01S	5	17	25.6	22.5	17	17.2	17.7
	1/4	KQG2S10-02S	8		27.5	22.8		19.1	
	3/8	KQG2S10-03S	8		24	18.9		39	20.9
	1/2	KQG2S10-04S	22		24	17.6		37.2	
	1/4	KQG2S12-02S	8		19	30.6		25.9	46
$\phi 10$	3/8	KQG2S12-03S	10	19	24.9	19.8	18.6	60	19.3
	1/2	KQG2S12-04S	22		24.9	18.5		33.6	
	3/8	KQG2S16-03S	10		24.6	33.2		28.1	81
$\phi 16$	1/2	KQG2S16-04S	12	24.6	29.4	23	20.8	113	38.4

* Reference dimensions after installation of R thread
 Note 1) ϕD is maximum diameter.
 Note 2) Value of FEP tubing.
 Value of nylon tubing for $\phi 16$ only.

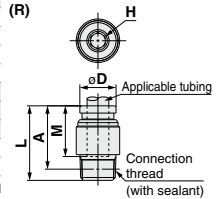
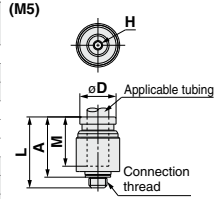

Straight Union: KQG2H



Applicable tubing O.D. (mm)	Model	ϕD Note 1)	L	M	Note 2) Effective area (mm ²)	Weight (g)
$\phi 3.2$	KQG2H23-00	9	25	12	3.4	6.5
$\phi 4$	KQG2H04-00	9	26.2	12.6	5.6	6.5
$\phi 6$	KQG2H06-00	12	28.2	13.6	13.1	11.5
$\phi 8$	KQG2H08-00	14	33.2	16.1	26.1	16.6
$\phi 10$	KQG2H10-00	17	35	17	41.5	26
$\phi 12$	KQG2H12-00	19	38.2	18.6	58.3	32.2
$\phi 16$	KQG2H16-00	24.6	42.6	20.8	113	53.7

Note 1) ϕD is maximum diameter.
 Note 2) Value of FEP tubing.
 Value of nylon tubing for $\phi 16$ only.

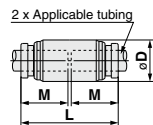

Series KQG2

Applicable Tubing: Metric Size, Connection Thread: M, R, Rc

Dimensions

Male Elbow: KQG2L



Applicable tubing O.D. (mm)	Connection thread R, M	Model	H (With across flat)	Note 1) ϕD	L1	L2	A*	M	Note 2) Effective area (mm ²)	Weight (g)		
$\phi 3.2$	M5 x 0.8	KQG2L23-M5	8	8.3	13.1	14.8	16	12	2.6	6.3		
	1/8	KQG2L23-01S	10		13.6	14.9	15.9					
	1/4	KQG2L23-02S	14		18.7	18.1	3				16	
$\phi 4$	M5 x 0.8	KQG2L04-M5	8	9.1	13.7	15.2	16.8	12.6	3.5	6.9		
	1/8	KQG2L04-01S	10		14.4	15.3	16.7					
	1/4	KQG2L04-02S	14		19.1	18.9	4.2				16.8	
$\phi 6$	M5 x 0.8	KQG2L06-M5	8	11.4	14.7	16.3	19	13.6	3.5	8.8		
	1/8	KQG2L06-01S	10		16.4							
	1/4	KQG2L06-02S	14		20.2	21.2	11.4				10.1	
$\phi 8$	3/8	KQG2L06-03S	14	13.7	21.6	22.2		16.1	21.6	20.3		
	1/8	KQG2L08-01S	12		18.6	18.3	22				14.6	
	1/4	KQG2L08-02S	14		19.1	21.5	23.6				16.1	21.6
$\phi 10$	3/8	KQG2L08-03S	17	16.6	22.9	24.6		17	35.2	33.6		
	1/8	KQG2L10-01S	12		20	19.7	24.9				21.6	20.2
	1/4	KQG2L10-02S	14		22.9	26.5					17	23.3
$\phi 12$	3/8	KQG2L10-03S	17	18.7	24.3	27.5		18.6	50.2	33.7		
	1/2	KQG2L10-04S	22		28.5	30.4					27.1	
	1/4	KQG2L12-02S	14		22.6	24	28.6				18.6	50.2
$\phi 16$	3/8	KQG2L12-03S	17	24.6	23.6	25.3	29.5	20.8	71	46.3		
	1/2	KQG2L12-04S	22		29.5	32.4					58.7	
	3/8	KQG2L16-03S	19		26.3	28	34.5				100	61.3
1/2	KQG2L16-04S	22	27.3	31.8	37							

* Reference dimensions after installation of R thread
Note 1) ϕD is maximum diameter.

Note 2) Value of FEP tubing.
Value of nylon tubing for $\phi 16$ only.

(M5)

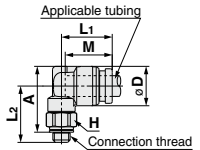

(R)

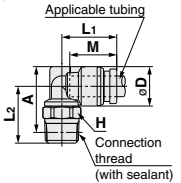

Male Branch Tee: KQG2T



Applicable tubing O.D. (mm)	Connection thread R, M	Model	H (With across flat)	Note 1) ϕD	L1	L2	A*	M	Note 2) Effective area (mm ²)	Weight (g)	
$\phi 3.2$	M5 x 0.8	KQG2T23-M5	8	8.3	13.1	14.8	16	12	3.2	8.1	
	1/8	KQG2T23-01S	10		13.6	14.9	15.9				
	1/4	KQG2T23-02S	14		18.7	18.1	3.4				9.4
$\phi 4$	M5 x 0.8	KQG2T04-M5	8	9.1	13.7	15.2	16.8	12.6	4.5	9	
	1/8	KQG2T04-01S	10		14.4	15.3	16.7				
	1/4	KQG2T04-02S	14		19.1	18.9	6				10.4
$\phi 6$	M5 x 0.8	KQG2T06-M5	8	11.4	14.7	16.3	19	13.6	4.5	11.9	
	1/8	KQG2T06-01S	10		16.4						
	1/4	KQG2T06-02S	14		20.2	21.2	13.9				21.8
$\phi 8$	3/8	KQG2T06-03S	14	13.7	21.6	22.2		16.1	26.3	33.3	
	1/8	KQG2T08-01S	12		18.6	18.3	22				20
	1/4	KQG2T08-02S	14		19.1	21.5	23.6				16.1
$\phi 10$	3/8	KQG2T08-03S	17	16.6	22.9	24.6		17	40.8	36.8	
	1/8	KQG2T10-01S	12		20	19.7	24.9				28.4
	1/4	KQG2T10-02S	14		22.9	26.5					17
$\phi 12$	3/8	KQG2T10-03S	17	18.7	24.3	27.5		18.6	57.2	39.3	
	1/2	KQG2T10-04S	22		28.5	30.4					68
	1/4	KQG2T12-02S	14		22.6	24	28.6				18.6
$\phi 16$	3/8	KQG2T12-03S	17	24.6	23.6	25.3	29.5	20.8	71	63.7	
	1/2	KQG2T12-04S	22		29.5	32.4					68.8
	3/8	KQG2T16-03S	19		26.3	28	34.5				100
1/2	KQG2T16-04S	22	27.3	31.8	37						

* Reference dimensions after installation of R thread
Note 1) ϕD is maximum diameter.

Note 2) Value of FEP tubing.
Value of nylon tubing for $\phi 16$ only.

(M5)

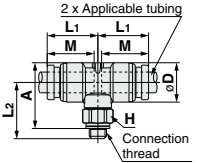

(R)

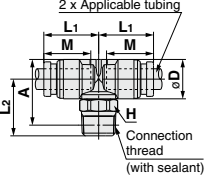

Union Elbow: KQG2L



Applicable tubing O.D. (mm)	Model	Note 1) ϕD	L	A	Q	M	ϕN	ϕO	Note 2) Effective area (mm ²)	Weight (g)
$\phi 3.2$	KQG2L23-00	8.3	13.6	19.3	2.9	12	3.2	5.6	3	6.3
$\phi 4$	KQG2L04-00	9.1	14.6	20.5	3.1	12.6	3.2	5.6	4.2	7.4
$\phi 6$	KQG2L06-00	11.4	16.6	23	3.6	13.6	3.2	5.6	11.4	11
$\phi 8$	KQG2L08-00	13.7	20.1	29.1	5	16.1	4.2	8	21.6	20.2
$\phi 10$	KQG2L10-00	16.6	22	31.7	5.7	17	4.2	8	35.2	29.6
$\phi 12$	KQG2L12-00	18.7	24.6	35	6.4	18.6	4.2	8	50.2	37.1
$\phi 16$	KQG2L16-00	24.6	28.8	40.5	7.7	20.8	4.2	8	100	59.7

Note 1) ϕD is maximum diameter.

Note 2) Value of FEP tubing.
Value of nylon tubing for $\phi 16$ only.

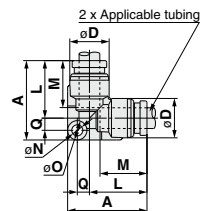

Stainless Steel 316 One-touch Fittings *Series KQG2*

Applicable Tubing: Metric Size, Connection Thread: M, R, Rc

Dimensions

Bulkhead Union: KQG2E



Applicable tubing O.D. (mm)	Model	T (M)	H (Width across flat)	L	Mounting hole	M	Note 2) Effective area (mm ²)	Weight (g)
ø3.2	KQG2E23-00	M10 x 1	12	32.2	11	12	3.4	14
ø4	KQG2E04-00	M10 x 1	12	32.4	11	12.6	5.6	14
ø6	KQG2E06-00	M14 x 1	17	33.6	15	13.6	13.1	25.8
ø8	KQG2E08-00	M15 x 1	19	36.4	16	16.1	26.1	30.4
ø10	KQG2E10-00	M18 x 1	21	37.2	19	17	41.5	40.3
ø12	KQG2E12-00	M20 x 1	24	39.2	21	18.6	58.3	49.9
ø16	KQG2E16-00	M27 x 1	30	42.6	28	20.8	113	87.3

Mounting plate thickness 7 mm or smaller
2 x Applicable tubing

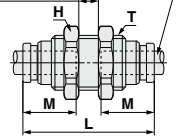

Note 1) Value of FEP tubing.
Value of nylon tubing for ø16 only.

Union Tee: KQG2T



Applicable tubing O.D. (mm)	Model	Note 1) øD	L	A	Q	M	øN	øO	Note 2) Effective area (mm ²)	Weight (g)
ø3.2	KQG2T23-00	8.3	13.6	20.5	4.1	12	3.2	5.6	3.4	7.9
ø4	KQG2T04-00	9.1	14.6	21.8	4.4	12.6	3.2	5.6	6.4	9.5
ø6	KQG2T06-00	11.4	24.6	24.6	5.2	13.6	3.2	5.6	13.4	14.2
ø8	KQG2T08-00	13.7	20.1	31.1	7	16.1	4.2	8	25.6	24.4
ø10	KQG2T10-00	16.6	22	34	8	17	4.2	8	40	36.8
ø12	KQG2T12-00	18.7	24.6	37.7	9.1	18.6	4.2	8	57.4	46.9
ø16	KQG2T16-00	24.6	28.8	43.4	10.6	20.8	4.2	8	100	75.5

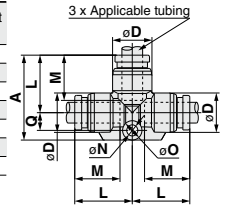

Note 1) øD is maximum diameter.
Note 2) Value of FEP tubing.
Value of nylon tubing for ø16 only.

Union "Y": KQG2U



Applicable tubing O.D. (mm)	Model	Note 1) øD	W	L1	L2	P	M	øN	øO	Note 2) Effective area (mm ²)	Weight (g)
ø3.2	KQG2U23-00	8.3	16.4	29	11	8.1	12	3.2	5.6	3.4	9.2
ø4	KQG2U04-00	9.1	18.2	30.4	11.3	9.1	12.6	3.2	5.6	4.2	11.1
ø6	KQG2U06-00	11.4	22.9	34.9	12.2	11.5	13.6	3.2	5.6	13.4	18.8
ø8	KQG2U08-00	13.7	28.3	40.1	14.1	14.6	16.1	4.2	8	25.6	29.7
ø10	KQG2U10-00	16.6	34.2	44	14.4	17.6	17	4.2	8	40	47.4
ø12	KQG2U12-00	18.7	38.5	48.4	15.8	19.8	18.6	4.2	8	57.4	62.1
ø16	KQG2U16-00	24.6	49.3	56.6	17.3	26	20.8	4.2	8	113	110.2

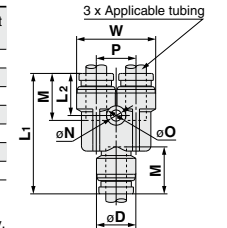

Note 1) øD is maximum diameter.
Note 2) Value of FEP tubing.
Value of nylon tubing for ø16 only.

Different Diameter Tee: KQG2T



Applicable tubing O.D. (mm)	Model	Note 1) øD1	Note 1) øD2	L1	L2	L3	Q	M1	M2	øN	øO	Note 2) Effective area (mm ²)	Weight (g)
ø3.2 ø4	KQG2T23-04	9.1	8.3	14.2	14.1	21.1	4.1	12.6	12	3.2	5.6	3.8	8.5
ø4 ø6	KQG2T04-06	11.4	9.1	15.6	15.7	22.8	4.4	13.6	12.6	3.2	5.6	7.1	11.5
ø6 ø8	KQG2T06-08	13.7	11.4	19.1	17.7	29.5	6.4	16.1	13.6	4.2	8	16.4	20
ø8 ø10	KQG2T08-10	16.6	13.7	21	21.2	32.1	7.1	17	16.1	4.2	8	36	29.8
ø10 ø12	KQG2T10-12	18.7	16.6	23.6	23.1	35.7	8.1	18.6	17	4.2	8	56	41.3
ø12 ø16	KQG2T12-16	24.6	18.7	26.8	26.7	39.9	9.1	20.8	18.6	4.2	8	108.5	58

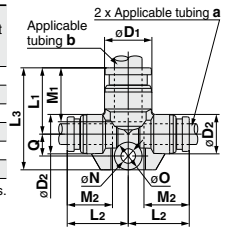

Note 1) øD1, øD2 are maximum diameters.
Note 2) Value of FEP tubing.

Plug-in Reducer: KQG2R



Applicable tubing O.D. (mm)	Applicable fitting size ød	Model	Note 1) øD	L	A	M	Note 2) Effective area (mm ²)	Weight (g)
ø3.2	ø4	KQG2R23-04	9	32.9	20.3	12	3.4	4.7
ø4	ø6	KQG2R04-06	9	34.4	20.8	12.6	5.6	6.7
ø6	ø8	KQG2R06-08	12	38.2	22.3	13.6	13.1	12.1
ø8	ø10	KQG2R08-10	14	41.9	24.9	16.1	26.1	18.3
ø10	ø12	KQG2R10-12	17	44.8	26.2	17	41.5	26.5
ø12	ø16	KQG2R12-16	19	42.9	22.1	18.6	58.3	35.4

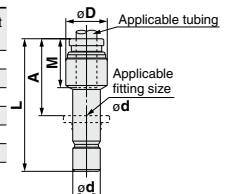

Note 1) øD is maximum diameter.
Note 2) Value of FEP tubing.

- KQ2
- KQB2
- KS
- KX
- KM
- KF
- M
- H/DL
- L/L
- KC
- KK
- KK130
- DM
- KDM
- KB
- KR
- KA
- KQG2
- KG
- KFG2
- MS
- KKA
- KP
- LQ
- MQR
- T

Series KQG2

Applicable Tubing: Metric Size, Connection Thread: M, R, Rc

Dimensions

Different Diameter Straight: KQG2H



Applicable tubing O.D. (mm)		Model	Note 1) ϕD	L	M ₁	M ₂	Note 2) Effective area (mm ²)	Weight (g)
a	b							
$\phi 3.2$	$\phi 4$	KQG2H23-04	9	25.6	12	12.6	3.4	6.5
$\phi 4$	$\phi 6$	KQG2H04-06	12	27.2	12.6	13.6	5.6	11.6
$\phi 6$	$\phi 8$	KQG2H06-08	14	30.7	13.6	16.1	13.1	16.3
$\phi 8$	$\phi 10$	KQG2H08-10	17	34.1	16.1	17	26.1	26
$\phi 10$	$\phi 12$	KQG2H10-12	19	36.6	17	18.6	41.5	33.3
$\phi 12$	$\phi 16$	KQG2H12-16	24.6	40.4	18.6	20.8	58.3	54.7

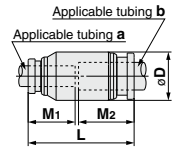

Note 1) ϕD is maximum diameter.

Note 2) Value of FEP tubing.

Different Diameter Union "Y": KQG2U



Applicable tubing O.D. (mm)		Model	Note 1) ϕD	L ₁	L ₂	P	W	M ₁	M ₂	ϕN	ϕO	Note 2) Effective area (mm ²)	Weight (g)
a	b												
$\phi 3.2$	$\phi 4$	KQG2U23-04	9.1	27	10.8	8.1	16.4	12	12.6	3.2	5.6	3.2	8.5
$\phi 4$	$\phi 6$	KQG2U04-06	11.4	29.3	11.2	9.1	18.2	12.6	13.6	3.2	5.6	4.2	11.9
$\phi 6$	$\phi 8$	KQG2U06-08	13.7	33.7	12.2	11.5	22.9	13.6	16.1	4.2	8	13.4	19.3
$\phi 8$	$\phi 10$	KQG2U08-10	16.6	38.3	13.8	14.6	28.3	16.1	17	4.2	8	25.6	31.6
$\phi 10$	$\phi 12$	KQG2U10-12	18.7	43	14	17.6	34.2	17	18.6	4.2	8	40	47.6
$\phi 12$	$\phi 16$	KQG2U12-16	24.6	47.4	15.6	19.8	38.5	18.6	20.8	4.2	8	57.4	67.6

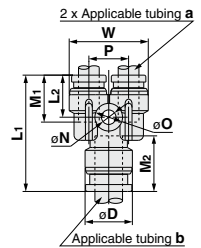

Note 1) ϕD is maximum diameter.

Note 2) Value of FEP tubing.

Bulkhead Connector: KQG2E



Applicable tubing O.D. (mm)	Connection thread Rc	Model	T (M)	Width across flat		L ₁	L ₂	Mounting hole	M	Note 2) Effective area (mm ²)	Weight (g)
				H ₁	H ₂						
$\phi 3.2$	1/4	KQG2E23-02	M10 x 1	17	12	31	14.8	11	12	3.4	26.1
	1/8	KQG2E04-01	M10 x 1	14	12	25.8	9.7				16
$\phi 4$	1/4	KQG2E04-02	M10 x 1	17	12	30.9	14.8	11	12.6	5.6	25.6
	1/8	KQG2E06-01	M14 x 1	17	17	24.2	7				24.4
$\phi 6$	1/4	KQG2E06-02	M14 x 1	19	17	30.9	13.7	15	13.6	13.1	30.9
	3/8	KQG2E06-03	M14 x 1	19	19	32.1	14.9				32
$\phi 8$	1/8	KQG2E08-01	M15 x 1	17	19	26.3	8.1				28
	1/4	KQG2E08-02	M15 x 1	19	19	31.3	13.1	16	16.1	26.1	31.2
$\phi 10$	3/8	KQG2E08-03	M15 x 1	19	19	32.8	14.6				32.7
	1/4	KQG2E10-02	M18 x 1	19	21	31.6	13	19	17	41.5	42.8
$\phi 12$	3/8	KQG2E10-03	M18 x 1	19	21	33	14.4				37.5
	1/2	KQG2E12-03	M20 x 1	21	24	34	14.4	21	18.6	58.3	50.3
$\phi 16$	1/2	KQG2E12-04	M20 x 1	24	24	39.3	19.7				60.7
	3/8	KQG2E16-03	M27 x 1	29	30	35.3	13.3	28	20.8	96	107.8
	1/2	KQG2E16-04	M27 x 1	29	30	40.6	18.6			113	114.6

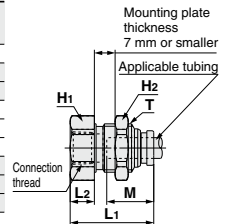

Note) Value of FEP tubing.

Value of nylon tubing for $\phi 16$ only.

Stainless Steel 316 One-touch Fittings *Series KQG2*

Applicable Tubing: Metric Size, Connection Thread: M, R, Rc

Dimensions

Extended Male Elbow: KQG2W

Applicable tubing O.D. (mm)	Connection thread R, M	Model	H (Width across flat)	Note 1) ϕD	L ₁	L ₂	A*	M	Note 2) Effective area (mm ²)	Weight (g)
$\phi 3.2$	M5 x 0.8	KQG2W23-M5	8	8.3	13.1	31.2	32.4	12	2.8	13
	1/8	KQG2W23-01S	10		13.6	31.3	32.3			14.7
	1/4	KQG2W23-02S	14							33.1
$\phi 4$	M5 x 0.8	KQG2W04-M5	8	9.1	13.7	31.6	33.2	12.6	3	13.6
	1/8	KQG2W04-01S	10		14.4	31.7	33.1			15.6
	1/4	KQG2W04-02S	14							33.9
$\phi 6$	M5 x 0.8	KQG2W06-M5	8	11.4	14.7	32.7	35.4	13.6	3	15.5
	1/8	KQG2W06-01S	10			32.8				17.2
	1/4	KQG2W06-02S	14		15.9	36.6	37.6			35.5
$\phi 8$	3/8	KQG2W06-03S	17	13.7		38	38.6	16.1	20.5	57.4
	1/8	KQG2W08-01S	12		18.6	37	40.7			28
	1/4	KQG2W08-02S	14		19.1	40.2	42.3			37.7
$\phi 10$	3/8	KQG2W08-03S	17	16.6		41.6	43.3	17	33.5	60.9
	1/4	KQG2W10-02S	14		21	46.6	50.2			40.7
	3/8	KQG2W10-03S	17			45.9	49.1			61.9
$\phi 12$	1/2	KQG2W10-04S	22	18.7		50.1	52	18.6	47.7	117.3
	1/4	KQG2W12-02S	14		22.6	47.7	52.3			44.6
	3/8	KQG2W12-03S	17			49	53.2			56.3
$\phi 16$	1/2	KQG2W12-04S	22	24.6		53.2	56.1	20.8	71	112.9
	3/8	KQG2W16-03S	19		26.3	57.6	64.1			86.6
	1/2	KQG2W16-04S	22			27.3	61.4			66.6

* Reference dimensions after installation of R thread
 Note 1) ϕD is maximum diameter.
 Note 2) Value of FEP tubing.
 Value of nylon tubing for $\phi 16$ only.

(M5)

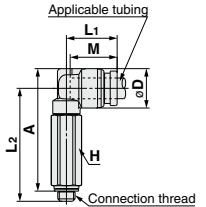

(R)

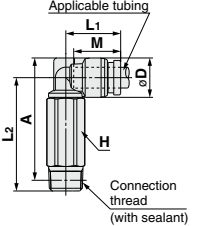

Female Connector: KQG2F

Applicable tubing O.D. (mm)	Connection thread Rc	Model	H (Width across flat)	Note 1) ϕD	L ₁	L ₂	M	Note 2) Effective area (mm ²)	Weight (g)	
$\phi 3.2$	1/8	KQG2F23-01	12	8	23.3	9.8	12	3.4	8.9	
	1/4	KQG2F04-02	17						9.2	
$\phi 4$	1/8	KQG2F04-01	12	8.7	28.7	13.2	12.6	5.6	21.6	
	1/4	KQG2F06-01	12			24.2			10	10.5
$\phi 6$	1/4	KQG2F06-02	17	11.1	29.2	13.4	13.6	13.1	23.1	
	3/8	KQG2F06-03	19			30.6			14.2	24.5
	1/8	KQG2F08-01	14			26.3			9.6	16.3
$\phi 8$	1/4	KQG2F08-02	17	13.4	31.3	13.7	16.1	26.1	25.5	
	3/8	KQG2F08-03	19			32.7			14.4	27
	1/4	KQG2F10-02	17			31.6			13.9	28.8
$\phi 10$	3/8	KQG2F10-03	19	16.4		33	17	41.5	30.4	
	1/4	KQG2F12-02	14			32.6			14.7	37.5
	3/8	KQG2F12-03	19			34			14.7	32.3
$\phi 12$	1/2	KQG2F12-04	24	18.5		39.3	18.4	58.3	50.2	
	3/8	KQG2F16-03	24			35.3			13.5	59.7
	1/2	KQG2F16-04	24			40.6			18.8	57

Note 1) ϕD is maximum diameter.
 Note 2) Value of FEP tubing.
 Value of nylon tubing for $\phi 16$ only.

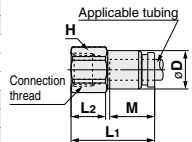

Plug: KQG2P

Applicable fitting size ϕd	Model	ϕD	L	A	Weight (g)
$\phi 3.2$	KQG2P-23	5	28.9	16.9	2.7
$\phi 4$	KQG2P-04	6	29.6	17	4.1
$\phi 6$	KQG2P-06	8	30.8	17.2	8.5
$\phi 8$	KQG2P-08	10	33.7	17.6	15.5
$\phi 10$	KQG2P-10	12	34.6	17.6	24.1
$\phi 12$	KQG2P-12	14	36.5	17.9	35.8
$\phi 16$	KQG2P-16	18	38.6	17.8	65.5

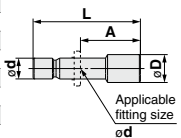

KQ2

KQB2

KS
KX

KM

KF

M

H/DL
L/LL

KC

KK

KK130

DM

KDM

KB

KR

KA

KQG2

KG

KFG2

MS

KKA

KP

LQ

MQR

T

Stainless Steel 316 One-touch Fittings

Applicable Tubing: Inch Size, Connection Thread: UNF, NPT

Series **KQG2**

RoHS



Applicable Tubing

Tubing material	FEP, PFA, Nylon, Soft nylon ^{Note 1)} , Polyurethane, Polyolefin
Tubing O.D.	ø1/8", ø5/32", ø1/4", ø5/16", ø3/8", ø1/2"

Specifications

Fluid	Air, Water, Steam ^{Note 2)} ^{Note 3)}
Operating pressure range ^{Note 4)}	-100 kPa to 1 MPa ^{Note 5)}
Proof pressure	3.0 MPa
Ambient and fluid temperature ^{Note 6)}	-5 to 150°C (No freezing) ^{Note 5)}
Lubricant	Grease-free specification
Seal on the threads	With sealant

Note 1) For soft nylon tubing, water cannot be used.

Note 2) Consult with SMC regarding applicable tubing separately.

Note 3) Using special FKM that is resistant even when steam is used.

Note 4) Avoid using in a vacuum holding application such as a leak tester, since there is leakage.

Note 5) Check the operating pressure range and operating temperature range of the tubing.

Note 6) It is recommended that you use the inner sleeve in the following conditions (Except ø1/8"):

- When using in an environment where the fluid temperature changes drastically.
- When using at a high temperature.

* Temperature Condition of Mounting the Inner Sleeve

Tubing	Temperature
FEP tubing/Series TH	80°C or more
Super PFA tubing/Series TL	120°C or more

Spare Parts

Description	Tubing O.D.	Part no.	Material
Gasket	—	M-5G3	Stainless steel 316, Special FKM
Bulkhead nut	ø1/8", ø5/32"	KQG201-P01	Stainless steel 316
	ø1/4"	KQG207-P01	
	ø5/16"	KQG209-P01	
	ø3/8"	KQG211-P01	
	ø1/2"	KQG213-P01	

Cross Reference Table of the Inner Sleeve

Tubing O.D.	Tubing material		Applicable inner sleeve	
	TH/THI (FEP)	TL/TIL (Super PFA)	Part no.	Length
ø5/32"	TH0402	—	TJG-0402	18
	TH0425	—	TJG-0425	18
	—	TL0403	TJG-0403	18
ø1/4"	TIHB07	TIL07	TJG-0604	19
	TIHA07	—	TJG-0746	19
ø5/16"	TH0806	TL0806	TJG-0806	20.5
ø3/8"	TIHB11	TIL11	TJG-1065	23
	TIHA11	—	TJG-1107	23
ø1/2"	TIH13	TIL13	TJG-1395	24

* Stainless steel 316 is used for the TJG series.

Construction

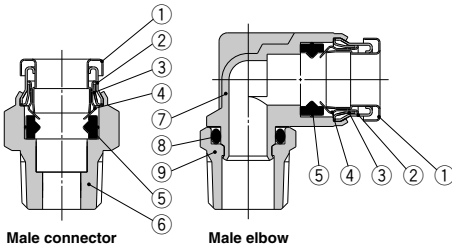

Component Parts

No.	Description	Material
1	Release button	Stainless steel 316
2	Guide 1	Stainless steel 316
3	Guide 2	Stainless steel 316
4	Chuck	Stainless steel 316
5	Seal	Special FKM (Fluoro coated)
6	Male connector body	Stainless steel 316
7	Male elbow body	Stainless steel 316
8	O-ring	Special FKM (Fluoro coated)
9	Stud	Stainless steel 316

Stainless Steel 316 One-touch Fittings **Series KQG2**

Applicable Tubing: Inch Size, Connection Thread: UNF, NPT

Dimensions

Male Connector: KQG2H



Applicable tubing O.D. (inch)	Connection thread UNF, NPT	Model	H (Width across flat)	Note 1) ϕD	L	A*	M	Note 2) Effective area (mm ²)	Weight (g)
$\phi 1/8"$	10-32UNF	KQG2H01-32	8	8	16.5	13.5	12	3	3.3
	1/8	KQG2H01-N01S	12		17.1	13.9		3.4	8.1
	1/4	KQG2H01-N02S	14		20.9	16.5		16.9	
$\phi 5/32"$	10-32UNF	KQG2H03-32	10	8.7	17.1	14.1	12.6	4	5
	1/8	KQG2H03-N01S	12		17	13.8		5.6	7.6
	1/4	KQG2H03-N02S	14		20.9	16.5		16.4	
$\phi 1/4"$	10-32UNF	KQG2H07-32	12	11.2	19	16	13.5	4	7.5
	1/8	KQG2H07-N01S	12		20	16.8		8.6	
	1/4	KQG2H07-N02S	14		20.6	16.2		14.2	
	3/8	KQG2H07-N03S	19		23.8	19.1		31.4	
	1/8	KQG2H09-N01S	14		24.2	21		12.6	
$\phi 5/16"$	1/4	KQG2H09-N02S	14	13.4	23.1	18.7	16.1	26.1	13.9
	3/8	KQG2H09-N03S	19		24.6	19.9		28.9	
	1/8	KQG2H11-N01S	17		25	21.8		26.1	19.4
$\phi 3/8"$	1/4	KQG2H11-N02S	17	16	26.3	21.9	16.6	41.5	20.3
	3/8	KQG2H11-N03S	19		23.6	18.9		25.2	
	1/2	KQG2H11-N04S	22		28.3	21.9		51.8	
	1/4	KQG2H13-N02S	17		30.5	26.1		36.7	
	3/8	KQG2H13-N03S	19		28.4	23.7		34.4	
$\phi 1/2"$	3/8	KQG2H13-N03S	19	19.3	28.4	23.7	18.5	58.3	34.4
	1/2	KQG2H13-N04S	22		28.4	22		43.4	

* Reference dimensions after installation of NPT thread
Note 1) ϕD is maximum diameter.
Note 2) Value of FEP tubing.

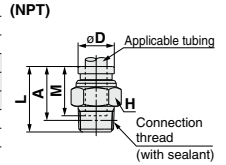
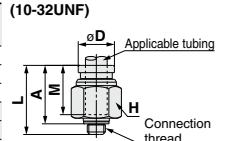

Hexagon Socket Head Male Connector: KQG2S



Applicable tubing O.D. (inch)	Connection thread UNF, NPT	Model	H (Width across flat)	Note 1) ϕD	L	A*	M	Note 2) Effective area (mm ²)	Weight (g)				
$\phi 1/8"$	10-32UNF	KQG2S01-32	2	9	16.5	13.5	12	3	3.8				
	10-32UNF	KQG2S03-32	2	9	17.1	14.1	12.6	4	3.7				
$\phi 5/32"$	10-32UNF	KQG2S03-N01S	2.78	11	19.6	16.4	12.6	4.1	8.5				
	10-32UNF	KQG2S07-32	2	12	19.5	16.5		4	7.2				
$\phi 1/4"$	1/8	KQG2S07-N01S	4.76	14	20.5	16.1	13.5	10	8.1				
	1/4	KQG2S07-N02S	18					10.7	13.4				
	3/8	KQG2S07-N03S	18					15.8	22.6				
$\phi 5/16"$	1/8	KQG2S09-N01S	5.56	14	24.7	21.5	16.1	17.2	12				
	1/4	KQG2S09-N02S	6.35					18	23.1	18.7	23.3	12.8	
	3/8	KQG2S09-N03S	18								18.4	23.5	
$\phi 3/8"$	1/8	KQG2S11-N01S	5.56	17	25.2	22	16.6	17.2	17.8				
	1/4	KQG2S11-N02S	6.35					18	27.1	22.7	21.2		
	3/8	KQG2S11-N03S	18								23.6	18.9	23.8
	1/2	KQG2S11-N04S	22								23.6	17.2	38.6
	$\phi 1/2"$	1/4	KQG2S13-N02S					8	20	30.5	26.1	18.5	46
3/8		KQG2S13-N03S	9.53	22	29.4	24.7	60	29					
1/2		KQG2S13-N04S	22				25.5	19.1					34.8

* Reference dimensions after installation of NPT thread
Note 1) ϕD is maximum diameter.
Note 2) Value of FEP tubing.

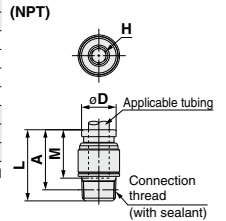
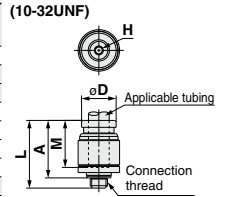

Straight Union: KQG2H



Applicable tubing O.D. (inch)	Model	ϕD Note 1)	L	M	Note 2) Effective area (mm ²)	Weight (g)
$\phi 1/8"$	KQG2H01-00	9	25	12	3.4	6.5
$\phi 5/32"$	KQG2H03-00	9	26.2	12.6	5.6	6.5
$\phi 1/4"$	KQG2H07-00	12	28	13.5	13.1	11
$\phi 5/16"$	KQG2H09-00	14	33.2	16.1	26.1	16.6
$\phi 3/8"$	KQG2H11-00	16	34.2	16.6	41.5	22.7
$\phi 1/2"$	KQG2H13-00	20	38	18.5	58.3	35.5

Note 1) ϕD is maximum diameter.
Note 2) Value of FEP tubing.

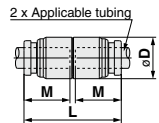

KQ2

KQB2

KS
KX

KM

KF

M

H/DL
L/LL

KC

KK

KK130

DM

KDM

KB

KR

KA

KQG2

KG

KFG2

MS

KKA

KP

LQ

MQR

T

Series KQG2

Applicable Tubing: Inch Size, Connection Thread: UNF, NPT

Dimensions

Male Elbow: KQG2L

Applicable tubing O.D. (inch)	Connection thread UNF, NPT	Model	H (With across flat)	Note 1) øD	L1	L2	A*	M	Note 2) Effective area (mm ²)	Weight (g)		
ø1/8"	10-32UNF	KQG2L01-32	8	8.3	13.1	14.8	16	12	2.6	6.3		
	1/8	KQG2L01-N01S	12		13.6	14.9	15.8				9	
	1/4	KQG2L01-N02S	14		13.7	15.2	16.8				3	16.7
ø5/32"	10-32UNF	KQG2L03-32	8	9.1	13.7	15.2	16.8	12.6	3.5	6.9		
	1/8	KQG2L03-N01S	12		14.4	15.3	16.6				4.2	9.9
	1/4	KQG2L03-N02S	14		14.7	16.5	19.3				3.5	8.9
ø1/4"	10-32UNF	KQG2L07-32	8	11.7	14.7	16.5	19.3	13.5	11.4	11.7		
	1/8	KQG2L07-N01S	12		15.9	20.4	21.8				19.4	
	1/4	KQG2L07-N02S	14		22.2	23.3	34.2					
ø5/16"	10-32UNF	KQG2L09-N01S	12	13.7	18.6	18.3	21.9	16.1	21.6	15.1		
	1/4	KQG2L09-N02S	14		19.1	21.5	23.9				21.1	
	3/8	KQG2L09-N03S	19		23.3	25.4	35.7					
ø3/8"	10-32UNF	KQG2L11-N01S	12	16	20	19.4	24.2	16.6	21.6	19.7		
	1/4	KQG2L11-N02S	14		22.6	26.2	23.2					
	3/8	KQG2L11-N03S	19		24.4	27.7	35.2				36.7	
ø1/2"	10-32UNF	KQG2L13-N02S	22	19.6	22.7	24.4	29.8	18.5	50.2	29.4		
	3/8	KQG2L13-N03S	19		26.1	31.2	39.2					
	1/2	KQG2L13-N04S	22		29.9	33.3	61.3					

* Reference dimensions after installation of NPT thread
 Note 1) øD is maximum diameter.
 Note 2) Value of FEP tubing.

(10-32UNF)

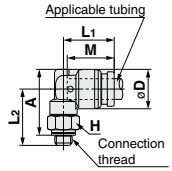

(NPT)

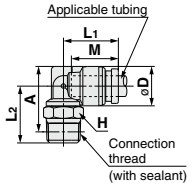

Male Branch Tee: KQG2T

Applicable tubing O.D. (inch)	Connection thread UNF, NPT	Model	H (With across flat)	Note 1) øD	L1	L2	A*	M	Note 2) Effective area (mm ²)	Weight (g)	
ø1/8"	10-32UNF	KQG2T01-32	8	8.3	13.1	14.8	16	12	3.2	8.1	
	1/8	KQG2T01-N01S	12		13.6	14.9	15.8				10.8
	1/4	KQG2T01-N02S	14		13.7	15.2	16.8				3.4
ø5/32"	10-32UNF	KQG2T03-32	8	9.1	13.7	15.2	16.8	12.6	4.5	9	
	1/8	KQG2T03-N01S	12		14.4	15.3	16.6				11.8
	1/4	KQG2T03-N02S	14		14.7	16.5	19.3				6
ø1/4"	10-32UNF	KQG2T07-32	8	11.7	14.7	16.5	19.3	13.5	4.5	12.1	
	1/8	KQG2T07-N01S	12		15.9	20.4	21.8				15.1
	1/4	KQG2T07-N02S	14		22.2	23.3	37.7				13.9
ø5/16"	10-32UNF	KQG2T09-N01S	12	13.7	18.6	18.3	21.9	16.1	26.3	20.4	
	1/4	KQG2T09-N02S	14		19.1	21.5	23.9				26.3
	3/8	KQG2T09-N03S	19		23.3	25.4	41				
ø3/8"	10-32UNF	KQG2T11-N01S	12	16	20	19.4	24.2	16.6	40.8	27.3	
	1/4	KQG2T11-N02S	14		22.6	26.2	30.5				
	3/8	KQG2T11-N03S	19		24.4	27.7	44				
ø1/2"	10-32UNF	KQG2T13-N02S	22	19.6	22.7	24.4	29.8	18.5	57.2	41.1	
	3/8	KQG2T13-N03S	19		26.1	31.2	50.2				
	1/2	KQG2T13-N04S	22		29.9	33.3	72.3				

* Reference dimensions after installation of NPT thread
 Note 1) øD is maximum diameter.
 Note 2) Value of FEP tubing.

(10-32UNF)

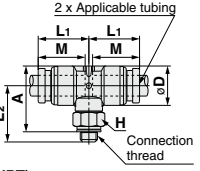

(NPT)

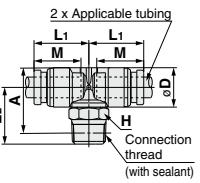

Union Elbow: KQG2L

Applicable tubing O.D. (inch)	Model	Note 1) øD	L	A	Q	M	øN	øO	Note 2) Effective area (mm ²)	Weight (g)
ø1/8"	KQG2L01-00	8.3	13.6	19.3	2.9	12	3.2	5.6	3	6.3
ø5/32"	KQG2L03-00	9.1	14.6	20.5	3.1	12.6	3.2	5.6	4.2	7.4
ø1/4"	KQG2L07-00	11.7	16.7	23.2	3.7	13.5	3.2	5.6	11.4	11.5
ø5/16"	KQG2L09-00	13.7	20.1	29.1	5	16.1	4.2	8	21.6	20.2
ø3/8"	KQG2L11-00	16	21.4	31.1	5.7	16.6	4.2	8	35.2	28.2
ø1/2"	KQG2L13-00	19.6	24.9	35.3	6.4	18.5	4.2	8	50.2	41.7

Note 1) øD is maximum diameter.
 Note 2) Value of FEP tubing.

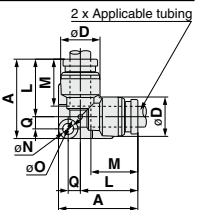

Stainless Steel 316 One-touch Fittings *Series KQG2*

Applicable Tubing: Inch Size, Connection Thread: UNF, NPT

Dimensions

Bulkhead Union: KQG2E



Applicable tubing O.D. (inch)	Model	T (UNF)	H (Width across flat)	L	Mounting hole	M	Note 2) Effective area (mm ²)	Weight (g)
ø1/8"	KQG2E01-00	7/16-20UNF	14	34.2	12.5	12	3.4	20.7
ø5/32"	KQG2E03-00	7/16-20UNF	14	34.4	12.5	12.6	5.6	20.5
ø1/4"	KQG2E07-00	1/2-20UNF	17	35.4	14	13.5	13.1	28
ø5/16"	KQG2E09-00	5/8-18UNF	19	39.6	17	16.1	26.1	39.5
ø3/8"	KQG2E11-00	3/4-16UNF	22	40.4	20.5	16.6	41.5	57.3
ø1/2"	KQG2E13-00	7/8-14UNF	26	44.4	23.5	18.5	58.3	83.2

Note) Value of FEP tubing.

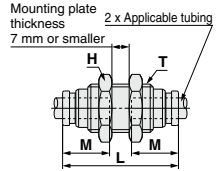

Union Tee: KQG2T



Applicable tubing O.D. (inch)	Model	Note 1) øD	L	A	Q	M	øN	øO	Note 2) Effective area (mm ²)	Weight (g)
ø1/8"	KQG2T01-00	8.3	13.6	20.5	4.1	12	3.2	5.6	3.4	7.9
ø5/32"	KQG2T03-00	9.1	14.6	21.8	4.4	12.6	3.2	5.6	6.4	9.5
ø1/4"	KQG2T07-00	11.7	16.7	24.7	5.2	13.5	3.2	5.6	13.4	14.7
ø5/16"	KQG2T09-00	13.7	20.1	31.1	7	16.1	4.2	8	25.6	24.4
ø3/8"	KQG2T11-00	16	21.4	33.4	8	16.6	4.2	8	40	34.7
ø1/2"	KQG2T13-00	19.6	24.9	37.9	9	18.5	4.2	8	57.4	52.3

Note 1) øD is maximum diameter.
Note 2) Value of FEP tubing.

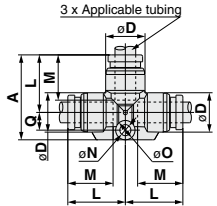

Union "Y": KQG2U



Applicable tubing O.D. (inch)	Model	Note 1) øD	W	L1	L2	P	M	øN	øO	Note 2) Effective area (mm ²)	Weight (g)
ø1/8"	KQG2U01-00	8.3	16.4	29	11	8.1	12	3.2	5.6	3.4	9.2
ø5/32"	KQG2U03-00	9.1	18.2	30.4	11.3	9.1	12.6	3.2	5.6	4.2	11.1
ø1/4"	KQG2U07-00	11.7	23.9	34.5	12.1	12.2	13.5	3.2	5.6	13.4	19.6
ø5/16"	KQG2U09-00	13.7	28.3	40.1	14.1	14.6	16.1	4.2	8	25.6	29.7
ø3/8"	KQG2U11-00	16	33.2	42.2	14	17.2	16.6	4.2	8	40	43.1
ø1/2"	KQG2U13-00	19.6	40.2	47.3	15.8	20.6	18.5	4.2	8	57.4	66.4

Note 1) øD is maximum diameter.
Note 2) Value of FEP tubing.

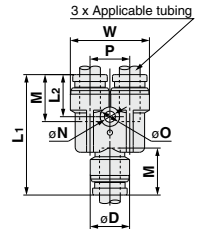

Different Diameter Tee: KQG2T



Applicable tubing O.D. (inch)	Model	Note 1) øD1	Note 1) øD2	L1	L2	L3	Q	M1	M2	øN	øO	Note 2) Effective area (mm ²)	Weight (g)
a 1/8" b 5/32"	KQG2T01-03	9.1	8.3	14.2	14.1	21.1	4.1	12.6	12	3.2	5.6	3.8	8.5
ø5/32" ø1/4"	KQG2T03-07	11.7	9.1	15.5	15.9	22.7	4.4	13.5	12.6	3.2	5.6	7.1	11.7
ø1/4" ø5/16"	KQG2T07-09	13.7	11.7	19.3	17.6	29.6	6.3	16.1	13.5	4.2	8	16.4	20.2
ø5/16" ø3/8"	KQG2T09-11	16	13.7	20.6	21	31.7	7.1	16.6	16.1	4.2	8	36	28.9
ø3/8" ø1/2"	KQG2T11-13	19.6	16	23.3	23	35.4	8.1	18.5	16.6	4.2	8	56	41.8

Note 1) øD1, øD2 are maximum diameters.
Note 2) Value of FEP tubing.

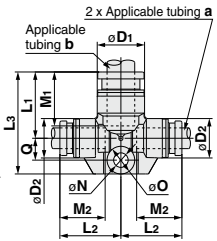

Plug-in Reducer: KQG2R



Applicable tubing O.D. (inch)	Applicable fitting size ød	Model	Note 1) øD	L	A	M	Note 2) Effective area (mm ²)	Weight (g)
ø1/8"	ø5/32"	KQG2R01-03	9	32.9	20.3	12	3.4	4.7
ø5/32"	ø1/4"	KQG2R03-07	9	33.7	20.2	12.6	5.6	7.1
ø1/4"	ø5/16"	KQG2R07-09	12	38.4	22.3	13.5	13.1	11.9
ø5/16"	ø3/8"	KQG2R09-11	14	41.6	25	16.1	26.1	16.8
ø3/8"	ø1/2"	KQG2R11-13	17	39.8	21.3	16.6	41.5	23.5

Note 1) øD is maximum diameter.
Note 2) Value of FEP tubing.

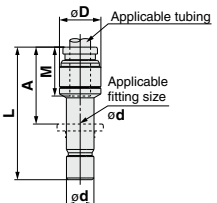

- KQ2
- KQB2
- KS
- KX
- KM
- KF
- M
- H/DL
- L/L
- KC
- KK
- KK130
- DM
- KDM
- KB
- KR
- KA
- KQG2
- KG
- KFG2
- MS
- KKA
- KP
- LQ
- MQR
- T

Series KQG2

Applicable Tubing: Inch Size, Connection Thread: UNF, NPT

Dimensions

Different Diameter Straight: KQG2H



Applicable tubing O.D. (inch)		Model	øD Note 1)	L	M ₁	M ₂	Note 2) Effective area (mm ²)	Weight (g)
a	b							
ø1/8"	ø5/32"	KQG2H01-03	9	25.6	12	12.6	3.4	6.5
ø5/32"	ø1/4"	KQG2H03-07	12	27.1	12.6	13.5	5.6	11.3
ø1/4"	ø5/16"	KQG2H07-09	14	30.6	13.5	16.1	13.1	16.1
ø5/16"	ø3/8"	KQG2H09-11	16	33.7	16.1	16.6	26.1	22.8
ø3/8"	ø1/2"	KQG2H11-13	20	36.1	16.6	18.5	41.5	37.1

Note 1) øD is maximum diameter.
Note 2) Value of FEP tubing.

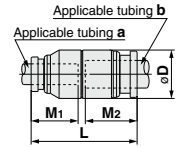

Different Diameter Union "Y": KQG2U



Applicable tubing O.D. (inch)		Model	Note 1) øD	L ₁	L ₂	P	W	M ₁	M ₂	øN	øO	Note 2) Effective area (mm ²)	Weight (g)
a	b												
ø1/8"	ø5/32"	KQG2U01-03	9.1	27	10.8	8.1	16.4	12	12.6	3.2	5.6	3.2	8.5
ø5/32"	ø1/4"	KQG2U03-07	11.7	28.8	11.4	9.1	18.2	12.6	13.5	3.2	5.6	4.2	11.8
ø1/4"	ø5/16"	KQG2U07-09	13.7	33.8	12	12.2	23.9	13.5	16.1	4.2	8	13.4	20
ø5/16"	ø3/8"	KQG2U09-11	16	38.3	13.8	14.6	28.3	16.1	16.6	4.2	8	25.6	31
ø3/8"	ø1/2"	KQG2U11-13	19.6	40.5	13.7	17.2	33.2	16.6	18.5	4.2	8	40	45

Note 1) øD is maximum diameter.
Note 2) Value of FEP tubing.

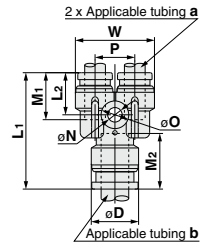

Bulkhead Connector: KQG2E



Applicable tubing O.D. (inch)	Connection thread NPT	Model	T (UNF)	Width across flat		L ₁	L ₂	Mounting hole	M	Note 2) Effective area (mm ²)	Weight (g)
				H ₁	H ₂						
ø1/8"	1/4	KQG2E01-N02	7/16-20UNF	17	14	32.8	15.3	12.5	12	3.4	30.6
ø5/32"	1/4	KQG2E03-N02	7/16-20UNF	17	14	32.6	15.3	12.5	12.6	5.6	30.1
ø1/4"	1/4	KQG2E07-N02	1/2-20UNF	17	17	32.7	14.8	14	13.5	5.1	32.6
ø5/16"	3/8	KQG2E09-N03	5/8-18UNF	19	19	35	15.1	17	16.1	26.1	38.2
ø3/8"	3/8	KQG2E11-N03	3/4-18UNF	21	22	33.8	13.3	20.5	16.6	41.5	51.7
ø1/2"	3/8	KQG2E13-N03	7/8-14UNF	24	26	34.6	12.3	23.5	18.5	58.3	73.2
	1/2	KQG2E13-N04									

Note) Value of FEP tubing.

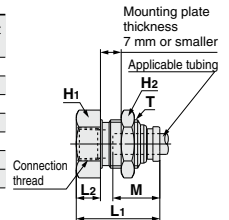

Extended Male Elbow: KQG2W



Applicable tubing O.D. (inch)	Connection thread NPT	Model	H (Width across flat)	Note 1) øD	L ₁	L ₂	A*	M	Note 2) Effective area (mm ²)	Weight (g)			
											ø1/8"	1/8	KQG2W01-N01S
1/4	KQG2W01-N02S	14	35.4	35.1	34.4								
ø5/32"	1/8	KQG2W03-N01S	12	9.1	14.4	32	33.3	12.6	4	22.4			
	1/4	KQG2W03-N02S	14								35.8	35.9	35.2
ø1/4"	1/8	KQG2W07-N01S	12	11.7	15.9	33.3	35.9	13.5	10.9	24.1			
	3/8	KQG2W07-N02S	14								37.1	38.5	37
	1/4	KQG2W07-N03S	19								38.9	40	70.9
ø5/16"	1/8	KQG2W09-N01S	12	13.7	18.6	40.2	42.6	16.1	20.5	26.9			
	1/4	KQG2W09-N02S	14								42	44.1	38.7
	3/8	KQG2W09-N03S	19								42	44.1	74.7
ø3/8"	1/4	KQG2W11-N02S	14	16	21	47.2	50.8	16.6	33.5	41.8			
	3/8	KQG2W11-N03S	19								45.4	48.7	75.2
	1/2	KQG2W11-N04S	22								49.2	50.8	116.5
ø1/2"	1/4	KQG2W13-N02S	14	19.6	22.7	49	54.4	18.5	47.7	47.9			
	3/8	KQG2W13-N03S	19								50.7	55.8	75.3
	1/2	KQG2W13-N04S	22								54.5	57.9	118.3

* Reference dimensions after installation of NPT thread
Note 1) øD is maximum diameter.
Note 2) Value of FEP tubing.

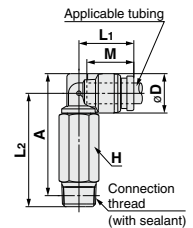

Stainless Steel 316 One-touch Fittings *Series KQG2*

Applicable Tubing: Inch Size, Connection Thread: UNF, NPT

Dimensions

Female Connector: KQG2F

Applicable tubing O.D. (inch)	Connection thread NPT	Model	H (Width across flat)	Note 1) ϕD	L ₁	L ₂	M	Note 2) Effective area (mm ²)	Weight (g)
ø1/8"	1/8	KQG2F01-N01	12	8	24.1	10.4	12	3.4	9.4
	1/4	KQG2F01-N02	17		29.1	13.7			22.5
ø5/32"	1/8	KQG2F03-N01	12	8.7	24.6	10.5	12.6	5.6	9.9
	1/4	KQG2F03-N02	17		29.6	13.8			23
ø1/4"	1/8	KQG2F07-N01	12	11.2	25	10.7	13.5	13.1	11.1
	1/4	KQG2F07-N02	17		30	14.1			24.5
	3/8	KQG2F07-N03	19		31.2	14.6			25.5
ø5/16"	1/8	KQG2F09-N01	14	13.4	27.2	10.3	16.1	26.1	17.3
	1/4	KQG2F09-N02	17		32.2	14.3			26.9
	3/8	KQG2F09-N03	19		33.4	14.8			28.1
ø3/8"	1/4	KQG2F11-N02	17	16	32.1	14.4	16.6	41.5	29.7
	3/8	KQG2F11-N03	19		33.3	14.9			30.9
	1/2	KQG2F11-N04	24		38.6	18.6			49.1
ø1/2"	3/8	KQG2F13-N03	21	19.3	34.6	14.7	18.5	58.3	43.3
	1/2	KQG2F13-N04	24		39.9	18.8			53.5

Note 1) ϕD is maximum diameter.
Note 2) Value of FEP tubing.

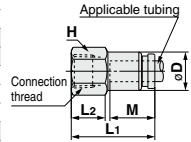

Plug: KQG2P

Applicable fitting size ϕd	Model	ϕD	L	A	Weight (g)
ø1/8"	KQG2P-01	5	28.9	16.9	2.7
ø5/32"	KQG2P-03	6	29.6	17	4.1
ø1/4"	KQG2P-07	8	30.3	16.8	8.9
ø5/16"	KQG2P-09	10	33.7	17.6	15.5
ø3/8"	KQG2P-11	11	34.1	17.5	21
ø1/2"	KQG2P-13	14	36.4	17.9	38.5

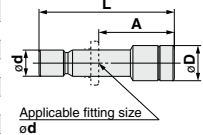

- KQ2
- KQB2
- KS
- KX
- KM
- KF
- M
- H/DL
- L/LL
- KC
- KK
- KK130
- DM
- KDM
- KB
- KR
- KA
- KQG2
- KG
- KFG2
- MS
- KKA
- KP
- LQ
- MQR
- T



Series **KQG2**

Applicable Fluid List

How to Read the Table

- ⊙: Completely unaffected or largely unaffected.
- : May be slightly affected, but, dependent upon condition, can sufficiently withstand.
- △: Advisable to use as little as possible.
- ×: Not applicable, as substantially affected.
- : No data is available.

Compatibility Checklist for Used Materials and Fluids

Chemical	Body	Seal
	Stainless steel 316	Special FKM
Acrylonitrile	⊙	×
Acetamide	○	○
Acetaldehyde	⊙	×
Acetone	⊙	×
Aniline	○	⊙
Amylene	⊙	—
Sulphurous acid gas (Humid gas)	⊙	—
Sodium bisulfite [50%]	⊙	—
Allyl alcohol	⊙	—
Benzoic acid	⊙	—
Ammonia (Compressed gas)	⊙	×
Isopropyl alcohol	○	⊙
Isophorone	×	—
Ethyl alcohol	⊙	○
Ethyl ether	○	×
Ethylene	⊙	—
Ethylene glycol	○	⊙
Ethylene diamine	⊙	—
Ethylene dichloride	⊙	—
Epichlorohydrine	⊙	×
Methyl tertiary butyl ether	—	×
Allyl chloride	×	—
Ammonium chloride	⊙	—
Calcium chloride	⊙	—
Iron(II) chloride [5%]	×	—
Sodium chloride	○	—
Magnesium chloride	⊙	—
Hydrochloric acid [5%]	×	—
Chlorine gas (Humid gas)	×	—
Carbitol	×	—
Formic acid [50%]	○	×
o-Xylene	△	△
p-Xylene	△	△
Citric acid	⊙	—
Cumene	×	—
Glycerin	⊙	⊙
Cresol	⊙	△

Chemical	Body	Seal
	Stainless steel 316	Special FKM
Chromic acid [10%]	⊙	—
Chlorosulfonic acid	○	×
Chlorofluorocarbon (CFC) 11	—	×
Chlorofluorocarbon (CFC) 113	—	×
Chlorofluorocarbon (CFC) 12	○	×
Chlorofluorocarbon (CFC) 13B1	—	×
Chlorofluorocarbon (CFC) 14	—	⊙
Chlorofluorocarbon (CFC) 22	○	×
Chlorobenzene	×	○
Chloroform (Trichloromethane)	○	○
Acetic acid	○	×
Amyl acetate	⊙	×
Isopropyl acetate [20%]	⊙	×
Ethyl acetate	×	×
Butyl acetate	×	×
Methyl acetate	⊙	×
Calcium hypochlorite	⊙	—
Sodium hypochlorite [5%]	⊙	⊙
Potassium cyanide [50%]	⊙	—
Copper cyanide	⊙	—
Diisobutyl ketone	⊙	—
Diisobutylene	—	⊙
Diethanolamine	⊙	—
Diethylamine	×	×
Diethylene glycol	⊙	—
Carbon tetrachloride	⊙	⊙
Cyclohexanol	×	—
Cyclohexanone	×	×
Cyclohexane	×	○
Dichloroethylene	—	△
Dichlorobenzene	—	△
Dichloromethane (Methylene chloride)	△	△
Ethylene bromide	×	—
Potassium bromide [30%]	⊙	—
Potassium dichromate [25%]	⊙	—
Oxalic acid	⊙	—
Bromine gas	×	—

Chemical	Body	Seal
	Stainless steel 316	Special FKM
Tartaric acid	○	—
Nitric acid [65%]	○	○
Ammonium nitrate	○	—
Ammonium hydroxide	—	○
Calcium hydroxide	○	—
Sodium hydroxide [50%]	○	○
Barium hydroxide	○	—
Solvent naphtha	○	—
Carbonic acid (Humid gas and aqueous solution)	○	—
Tetrachloroethylene	×	○
Tetrahydrofuran	—	×
Dodecylbenzene	○	—
Trichloroethane	△	—
Trichloroethylene	○	○
Trichloroacetic acid	—	—
Toluene	○	○
Naphtha	○	○
Naphthenic acid	○	—
Lactic acid	○	—
Carbon disulfide	○	○
Picric acid	○	—
Pyridine	×	×
Phenol	×	○
Butyl phthalate	×	—
Butyl alcohol	△	—
Hydrofluoric acid [50%]	○	—
Furfural	×	×
n-Propyl alcohol	○	—
Propylene glycol	○	—
Bromochloroethane	—	×
n-Hexane	○	○
n-Hexyl alcohol	○	—
n-Heptane	○	—
Benzene	×	×
n-Pentane	×	—
Boric acid	○	—
Gallic acid	○	—

Chemical	Body	Seal
	Stainless steel 316	Special FKM
Formic aldehyde	○	×
Methyl methacrylate	×	×
Methyl alcohol	○	○
Methyl isobutyl ketone	×	×
Methyl ethyl ketone	×	×
Ethyleneglycol monomethyl ether	×	—
Monoethanolamine	○	—
Morpholine	○	—
Butyric acid	○	—
Hydrogen sulfide (Humid gas and aqueous solution)	○	×
Sulphuric acid [10%]	○	○
Ammonium sulfate	○	×
Sodium bisulfate [10%]	○	—
Iron(II) sulfate	○	—
Sodium sulfate	○	—
Phosphoric acid [85%]	○	—

KQ2
KQB2
**KS
KX**
KM
KF
M
**H/DL
L/LL**
KC
KK
KK130
DM
KDM
KB
KR
KA
KQG2
KG
KFG2
MS
KKA
KP
LQ
MQR
T

Note 1) [] denotes the concentration. Aqueous solutions without condensation notes are in a saturated state.

Note 2) The above data is based on a room temperature of 20°C. Note that you may obtain different figures, depending on temperature conditions.

Note 3) The above data shows compatibility guidelines based upon component parts. Therefore, it is no guarantee of product performance. In addition, using fluids other than those specified in the catalog are not covered by the product's warranty.



Series KQG2

Specific Product Precautions

Be sure to read before handling. Refer to front matter 56 for Safety Instructions, pages 13 to 16 for Fittings and Tubing Precautions.

Selection

⚠ Caution

1. The surge pressure must be under the maximum operating pressure. If the surge pressure exceeds the maximum operating pressure, it will result in damage to fittings and tubing or the tubing may result in being fallen out.
2. If using a fluorescein tubing in an environment where the fluid temperature changes drastically, it is recommended to use an inner sleeve. Otherwise, air leakage may occur or the tube may release from fitting due to deformation of the tubing.
3. The particle generation of the KQG2 series depends on the operating conditions and operating environment. If you are concerned about the effects on machinery and equipment, check the particle generation with your machine before use.

The components of the KQG2 series may slide due to changes in the internal pressure, which may generate particles. When using male elbow, male branch tee, and extended male elbow fittings, particles may be generated by rotation for positioning after connecting.

Mounting

⚠ Caution

1. When performing the piping work, turn the tightening tool in the horizontal direction to the hex. across flats of the stud so that any moment is not applied to the body.

If the tool is in contact with the body, this may cause the stud to come off.

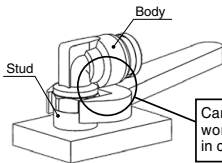

2. The union elbow, union tee, union "Y", different diameter tee and different diameter union "Y" should be fixed through the mounting hole.

Otherwise, air leakage or breaking can occur due to a pulling force or moment load created by the product's weight.

3. The elbow union, branch tee, and long elbow union can be turned for positioning after connecting, but they cannot be used while turning them.

Doing so may cause worn out metallic particles to enter the fluid or the fitting to break.

4. If the connection tube oscillates or turns, do not use this product.

Doing so may cause the fitting to break. In particular, for the product with the stud, this may cause the stud to come off.

Operating Environment

⚠ Warning

1. Avoid installing and using fittings inside a food zone.

Not installable

Food zone An environment where food which will be sold as merchandise, directly touches the fitting components.

Installable

Splash zone An environment where food which will not be sold as merchandise, directly touches the fitting components.

Non-food zone An environment where there is no contact with food.

Installation and Removal of Tubing

⚠ Caution

1. Installation of tubing

1) Grease is not used for the KQG2 series, therefore a greater insertion force is required when the tube is installed. In particular, polyurethane tubing may fold when inserted due to its softness. Hold the end of the tubing, and insert it all the way in slowly and securely. Refer to dimension "M" in the dimension drawings for guidance on the insertion depth of tube.

2. Removal of tubing

1) For tubing used at a high temperature or for an extended period of time, there is a possibility that it will not fit into a One-touch fitting again due to an enlarged O.D. Dispose of the tubing and replace it with a new one.

Proper Tightening Torque of Fittings

⚠ Caution

1. Tighten fittings with sealant using the proper tightening torques in the table below. As a rule, they should be tightened 2 to 3 turns with a tool after first tightening by hand.

If tightened using a torque exceeding the proper torque level, this may cause the fitting to break.

In particular, for the product with the stud, the stud may come off.

Connection thread size	Proper tightening torque N·m
NPT, R1/8	7 to 9
NPT, R1/4	12 to 14
NPT, R3/8	22 to 24
NPT, R1/2	28 to 30

Stainless steel

Metals exist in nature as ore (like oxide or sulfide). This means that oxide or sulfide is more stable than pure metal. Accordingly, metallic material chemically oxidizes (metallic constituent becomes ion and melts out). It corrodes in the natural environment. Even though corrosion of metal easily occurs in an environment where oxidizing tendency is stronger, some kinds of metal have a characteristic for which corrosion never happens if the level of oxidizing goes higher than a specific point. In such a case, it is called "metal in passive state".

Stainless steel has corrosion resistance because of a thin coat of passive state on its surface. However, there does not exist stainless steel with absolute corrosion resistance; therefore, many types of stainless steel have been developed for improved corrosion resistance performance.