

Flame Resistant One-touch Fittings

(Equivalent to UL-94 Standards V-0)

Series KR



Splatter Resistant

■ Applicable Tube

Tube material	FR double layer, FR soft nylon
Tube O.D.	ø6, ø8, ø10, ø12

■ Principal Element Material

Fitting are supplied without cover, order cover separately.

Two types of covers:

- Single layer tubing
Cap-KR□□C
Tubing-TRS
- Double layer tubing
Cap-KR□□C1
Tubing-TRB

Body	C3604BD, Flame resistance PBT (UL-94 standard V-0)
Stud (Thread)	C3604BD
Chuck	Stainless steel (SUS304)
Guide	C3604BD, Flame resistance PBT (UL-94 standard V-0)
Collet	Polycetal (POM)
Release button	Flame resistance PBT (UL-94 standard V-0)
Seal, O-ring	NBR
Cover	Flame resistance CR (UL-94 standard V-0)

■ Specifications

Operating fluid	Air, Water <small>Note1)</small>	
Max. operating pressure	145psi (1.0MPa)	
Proof pressure	435psi (3.0MPa)	
Ambient and fluid temperature	Air: 23° to 140°F (-5° to 60°C) Water: 32° to 105°F (0° to 40°C) (With no freezing)	
Thread	Mounting	JIS B0203 (Taper pipe thread)
	Nut	JIS B0211, Class 2 (Metric fine thread)
Sealant (Thread portion)	With sealant (Standard)	

Note1) Applicable to general industrial water. Consult SMC if using other fluids.
Surge pressure must be under the maximum operating pressure.

Series KR: Black body.

Guide

Collet

Chuck

Accepts FR soft nylon.
Has high retaining force. Chuck certainly bites tube and collet increase retaining force.

Seal

Can be used for a wide range of pressure from a low vacuum up to a pressure of 145psi (1.0MPa).

The Use of a special profile ensures positive sealing and reduced resistance when the

With sealant

Seal tape unnecessary
PAT.

Cover (Option)

Prevention of tube releasing unconformity due to an inside intrusion or adhesion of the splatter
Refer to P148 for the cover.

Release button (Green)

Low disconnecting force
When the fitting is removed, the chuck and collet are released, thus preventing them from biting into the tube to an unnecessary degree.

Tube

Body

O-ring

Stud

Effective when piping in a confined space

The body and thread portion can turn.

Flame Resistant One-touch Fittings

Series KR

Male Connector

KRH



Applicable tube O.D. Inch	Port size NPT	Model	Applicable tube O.D. mm	Port size R	Model
		KRH			KRH
1/4	1/8	KRH07-34S	6	1/8	KRH06-01S
	1/4	-35S		1/4	-02S
	3/8	-36S		3/8	-03S
3/8	1/4	KRH11-35S	8	1/8	KRH08-01S
	3/8	-36S		1/4	-02S
	1/2	-37S		3/8	-03S
1/2	1/4	KRH13-35S	10	1/8	KRH10-01S
	3/8	-36S		1/4	-02S
	1/2	-37S		3/8	-03S
			12	1/2	-04S
				1/4	KRH12-02S
				3/8	-03S
				1/2	-04S

Male Elbow

KRL



Applicable tube O.D. Inch	Port size NPT	Model	Applicable tube O.D. mm	Port size R	Model
		KRL			KRL
1/4	1/8	KRL07-34S	6	1/8	KRL06-01S
	1/4	-35S		1/4	-02S
	3/8	-36S		3/8	-03S
3/8	1/4	KRL11-35S	8	1/8	KRL08-01S
	3/8	-36S		1/4	-02S
	1/2	-37S		3/8	-03S
1/2	1/4	KRL13-35S	10	1/8	KRL10-01S
	3/8	-36S		1/4	-02S
	1/2	-37S		3/8	-03S
			12	1/2	-04S
				1/4	KRL12-02S
				3/8	-03S
				1/2	-04S

45° Male Elbow

KRK



Applicable tube O.D. mm	Port size R	Model
		KRK
6	1/8	KRK06-01S
	1/4	-02S
	3/8	-03S
8	1/8	KRK08-01S
	1/4	-02S
	3/8	-03S
10	1/8	KRK10-01S
	1/4	-02S
	3/8	-03S
12	1/2	-04S
	1/4	KRK12-02S
	3/8	-03S
	1/2	-04S

Flame Resistant One-touch Fittings

Series KR

Universal Male Elbow

KRV



Applicable tube O.D. mm	Port size R	Model
		KRV
6	1/8	KRV06-01S
	1/4	-02S
8	1/8	KRV08-01S
	1/4	-02S
	3/8	-03S
10	1/4	KRV10-02S
	3/8	-03S
12	3/8	KRV12-03S
	1/2	-04S

* Reference dimensions after R thread installation.

Branch "Y"

KRU



Applicable tube O.D. mm	Port size R	Model
		KRU
6	1/8	KRU06-01S
	1/4	-02S
	3/8	-03S
8	1/8	KRU08-01S
	1/4	-02S
	3/8	-03S
10	1/4	KRU10-02S
	3/8	-03S
	1/2	-04S
12	1/4	KRU12-02S
	3/8	-03S
	1/2	-04S

* Reference dimensions after R thread installation.

Union "Y"

KRU



Applicable tube O.D. mm	Model
	KRU
6	KRU06-00
8	KRU08-00
10	KRU10-00
12	KRU12-00

Plug-in "Y"

KRU



Applicable tube O.D. mm	Applicable fitting size ød	Model
		KRU
6	6	KRU06-99
8	8	KRU08-99
10	10	KRU10-99
12	12	KRU12-99

Flame Resistant One-touch Fittings

Series KR

Extended Male Elbow

KRW



Applicable tube O.D. mm	Port size R	Model
		KRW
6	1/8	KRW06-01S
	1/4	-02S
	3/8	-03S
8	1/8	KRW08-01S
	1/4	-02S
	3/8	-03S
10	1/4	KRW10-02S
	3/8	-03S
	1/2	-04S
12	1/4	KRW12-02S
	3/8	-03S
	1/2	-04S

Branch Tee

KRT



Applicable tube O.D. Inch	Port size NPT	Model	Applicable tube O.D. mm	Port size R	Model
		KRT			KRT
1/4	1/8	KRT07-34S	6	1/8	KRT06-01S
	1/4	-35S		1/4	-02S
	3/8	-36S		3/8	-03S
3/8	1/4	KRT11-35S	8	1/8	KRT08-01S
	3/8	-36S		1/4	-02S
	1/2	-37S		3/8	-03S
1/2	1/4	KRT13-35S	10	1/8	KRT10-01S
	3/8	-36S		1/4	-02S
	1/2	-37S		3/8	-03S
12	1/2	-37S	12	1/2	-04S
	1/4	KRT12-02S		1/4	KRT12-02S
	3/8	-03S		3/8	-03S
				1/2	-04S

Male Run Tee

KRY



Applicable tube O.D. Inch	Port size NPT	Model	Applicable tube O.D. mm	Port size R	Model
		KRY			KRY
1/4	1/8	KRY07-34S	6	1/8	KRY06-01S
	1/4	-35S		1/4	-02S
	3/8	-36S		3/8	-03S
3/8	1/4	KRY11-35S	8	1/8	KRY08-01S
	3/8	-36S		1/4	-02S
	1/2	-37S		3/8	-03S
1/2	1/4	KRY13-35S	10	1/8	KRY10-01S
	3/8	-36S		1/4	-02S
	1/2	-37S		3/8	-03S
12	1/2	-37S	12	1/2	-04S
	1/4	KRY12-02S		1/4	KRY12-02S
	3/8	-03S		3/8	-03S
				1/2	-04S

Flame Resistant One-touch Fittings

Series KR

Straight Union

KRH



Applicable tube O.D. mm	Model
	KRH
6	KRH06-00
8	KRH08-00
10	KRH10-00
12	KRH12-00

Bulkhead Union

KRE



Applicable tube O.D. Inch	Port size UNF	Model	Applicable tube O.D. mm	Model
		KRE		KRE
1/4	5/16-18	KRE07-00	6	KRE06-00
3/8	1/8-14	KRE11-00	8	KRE08-00
1/2	1-2	KRE13-00	10	KRE10-00
			12	KRE12-00

Union Elbow

KRL



Applicable tube O.D. Inch	Model	Applicable tube O.D. mm	Model
	KRL		KRL
1/4	KRL07-00	6	KRL06-00
3/8	KRL11-00	8	KRL08-00
1/2	KRL13-00	10	KRL10-00
		12	KRL12-00

Union Tee

KRT



Applicable tube O.D. Inch	Model	Applicable tube O.D. mm	Model
	KRT		KRT
1/4	KRT07-00	6	KRT06-00
3/8	KRT11-00	8	KRT08-00
1/2	KRT13-00	10	KRT10-00
		12	KRT12-00

Plug-in Reducer

KRR



Applicable tube O.D. Inch	Applicable fitting size	Model	Applicable tube O.D. mm	Applicable fitting size	Model
		KRR			KRR
1/4	3/8	KRR07-11	6	8	KRR06-08
	1/2	-13		10	-10
3/8	1/2	KRR11-13	8	10	KRR08-10
				12	-12
			10	12	KRR10-12

Flame Resistant One-touch Fittings

Series KR

Plug

KRP



Applicable fitting size Inch	Model
1/4	KRP-07
3/8	KRP-11
1/2	KRP-13

Applicable fitting size mm	Model
6	KRP-06
8	KRP-08
10	KRP-10
12	KRP-12

Spatter cover 1

KR



TIRS Tubing	
Applicable fitting size Inch	Model
1/4	KR-07C
3/8	KR-11C
1/2	KR-13C

TRS Tubing	
Applicable fitting size mm	Model
6	KR-06C
8	KR-08C
10	KR-10C
12	KR-12C

Spatter cover 2 (TRB Tubing)

KR



Applicable fitting size mm	Model
6	KR-06C1
8	KR-08C1
10	KR-10C1
12	KR-12C1

Made to Order

Made to Order

Electroless Nickel Plated on Brass Parts

X2

(Example) KRH06-02S-X2

Flame Resistant (Equivalent to UL-94 Standard V-0) FR One-touch Fittings Series **KR-W2**

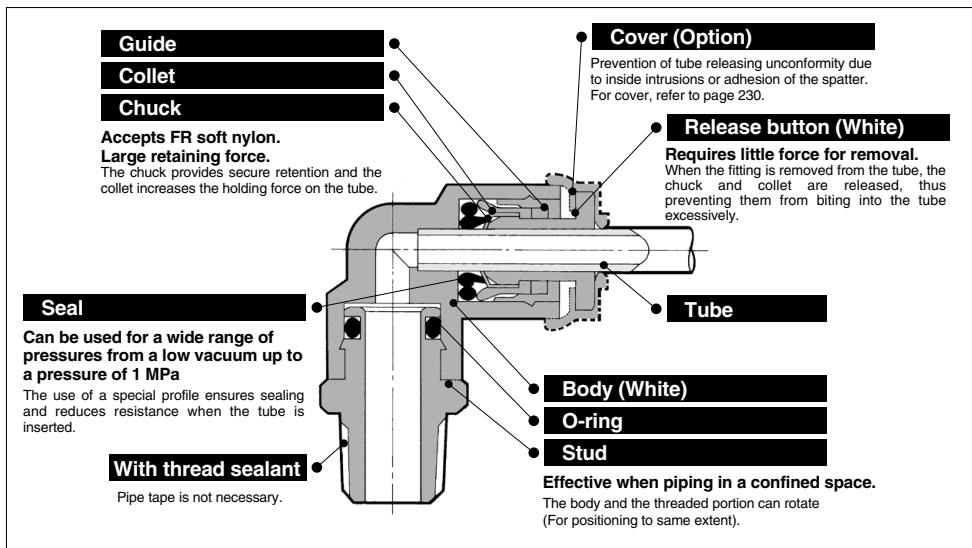

Applicable Tubing

Tubing material	FR double layer, FR soft nylon
Tubing O.D.	ø6, ø8, ø10, ø12

Specifications

Fluid		Air/Water ⁽¹⁾
Operating pressure range⁽²⁾		-100 kPa to 1 MPa
Proof pressure		3 MPa
Ambient and fluid temperature		-5 to 60°C (Water: 0 to 60°C) (No freezing)
Thread	Mounting section	JIS B 0203 (Taper thread for piping)
	Nut section	JIS B 0205 (Metric fine thread)
Seal on the threads		With sealant

Note 1) The surge pressure must be under the maximum operating pressure.

Note 2) Do not use the fittings with a leak tester or for vacuum retention because they are not guaranteed for zero leakage.



Made to Order

Symbol	Specifications
X2	Copper-free (With electroless nickel plated)

Suffix "X2" to the end of part number.
Example) KRH06-01SW2-X2

Principal Parts Material

Body	C3604, Flame resistant PBT (UL-94 standard V-0)
Stud	C3604 (Thread portion)
Chuck	Stainless steel 304
Guide	Stainless steel 304, Flame resistant PBT (UL-94 standard V-0)
Collet	POM
Release button	Flame resistant PBT (UL-94 standard V-0)
Seal, O-ring	NBR
Cover (Option)	Flame resistant PBT, Flame resistant CR (UL-94 standard V-0)

Model

Male connector

KRH-W2 P.226



Use to pipe in the same direction from female thread. Most general style.

Union elbow

KRL-W2 P.227



Use to connect tubes at right angles.

Plug-in reducer

KRR-W2 P.229



Use to size down One-touch fittings.

Straight union

KRH-W2 P.226



Use to connect tubes in the same direction.

Extended male elbow

KRW-W2 P.227



Basically, it is used together with male elbow. Different point is that it is used for fittings to avoid from interfering with each other by making the piping two-level.

Union "Y"

KRU-W2 P.228



Use to branch line in the same direction.

Male elbow

KRL-W2 P.226



Use to pipe at right angles to female thread. Most general style.

Extended plug-in elbow

KRW-W2 P.229



Use to change by 90° in a tube fetching direction from One-touch fittings. Can be used with the plug-in elbow for three-dimensional pipe arrangement.

Plug-in "Y"

KRU-W2 P.228



Use to branch line in the same direction from One-touch fittings.

45° male elbow

KRK-W2 P.226



Use to pipe in 45° angle direction from female thread. Model in-between of male connector and male elbow.

Male branch tee

KRT-W2 P.227



Use to branch line from female thread in both 90° directions.

Branch

KRU-W2 P.228



Use to branch line in the same direction from female thread.

Universal male elbow

KRV-W2 P.227



Universal male elbow allows thread connection by using a socket wrench for confined spaces.

Union tee

KRT-W2 P.227



Use to connect tubes in both 90° directions.

Bulkhead union

KRE-W2 P.229



Use to connect tubes through a panel.

Plug-in elbow

KRL-W2 P.229



Use to change by 90° in a tube fetching direction from One-touch fittings.

Male run tee

KRY-W2 P.228



Use to branch line in the same direction from female thread and in 90° direction.

Bulkhead Connector

KRE-W2 P.229



Use to connect male thread and tube through a panel.

Spatter cover

KR P.230



Prevention of tube releasing unconformity due to an inside intrusion or adhesion of the spatter.

Spatter cover

KR-□C1 P.230



Prevention of tube releasing unconformity due to an inside intrusion or adhesion of the spatter.

Plug

KRP P.230



Use to plug unused One-touch fittings.

KQ2

KQB2

**KS
KX**

KM

KF

M

**H/DL
L/LL**

KC

KK

KK130

DM

KDM

KB

KR

KA

KQG2

KG

KFG2

MS

KKA

KP

LQ

MQR

T

Series KR-W2

Dimensions

Male Connector: KRH-W2



Applicable tubing O.D. (mm)	Connection thread R	Model	H (width across flats)	L	A ^①	M	Effective area (mm ²)		Weight (g)
							FR double layer	FR soft nylon	
6	1/8	KRH06-01SW2	12	21.6	18.5	17	10.4	5.6	16
	1/4	KRH06-02SW2	14	22.5	17				14
	3/8	KRH06-03SW2	17	20.9	15.5				27
8	1/8	KRH08-01SW2	14	27.1	24	18.5	26.1	18.0	21
	1/4	KRH08-02SW2		26	20.5				19
	3/8	KRH08-03SW2		17	20.9				15.5
10	1/8	KRH10-01SW2	17	29.1	26	21	41.5	29.5	19
	1/4	KRH10-02SW2		33	27.5				30
	3/8	KRH10-03SW2		27	22.5				30
	1/2	KRH10-04SW2		22	26.1				19
12	1/4	KRH12-02SW2	19	34	28.5	22	58.3	46.1	42
	3/8	KRH12-03SW2		28	23.5				34
	1/2	KRH12-04SW2		22	29.1				22

* Reference dimensions after R thread installation.

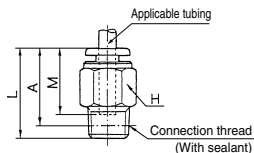

Straight Union: KRH-W2



Applicable tubing O.D. (mm)	Model	øD (Note)	L	M	Effective area (mm ²)		Weight (g)
					FR double layer	FR soft nylon	
6	KRH06-00W2	12.8	34.5	17	10.4	5.6	4
8	KRH08-00W2	15.2	38.5	18.5	26.1	18.0	6
10	KRH10-00W2	18.5	42.5	21	41.5	29.5	11
12	KRH12-00W2	20.9	44.5	22	58.3	46.1	14

Note) øD: Max. diameter

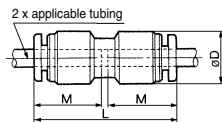

Male Elbow: KRL-W2



Applicable tubing O.D. (mm)	Connection thread R	Model	H (width across flats)	(1)		L1	L2	A ^①	M	Effective area (mm ²)		Weight (g)
				øD1	øD2					FR double layer	FR soft nylon	
6	1/8	KRL06-01SW2	10	12.8	10	20	22.1	25.5	19	9.0	4.2	12
	1/4	KRL06-02SW2	14				26.5	27.5				22
	3/8	KRL06-03SW2	17				27.9	29				33
8	1/8	KRL08-01SW2	12	15.2	12	23	23.6	28	20.5	21.6	14.9	13
	1/4	KRL08-02SW2	14				28	30				21
	3/8	KRL08-03SW2	17				29.4	31.5				35
10	1/8	KRL10-01SW2	17	18.5	17	26.5	26.1	32	23	21.6	14.9	25
	1/4	KRL10-02SW2					29.5	33				26
	3/8	KRL10-03SW2					30.9	34.5				36
	1/2	KRL10-04SW2					35.1	37				63
12	1/4	KRL12-02SW2	17	20.9	17	28.5	30.5	35.5	24	50.2	39.7	28
	3/8	KRL12-03SW2					31.9	37				38
	1/2	KRL12-04SW2					36.1	39.5				65

* Reference dimensions after R thread installation.

Note 1) øD1: Max. diameter

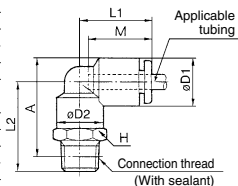

45° Male Elbow: KRK-W2



Applicable tubing O.D. (mm)	Connection thread R	Model	H (width across flats)	(1)		L1	L2	A ^①	M	Effective area (mm ²)		Weight (g)
				øD1	øD2					FR double layer	FR soft nylon	
6	1/8	KRK06-01SW2	10	12.8	10	18	19.6	33	19	6.9	3.4	12
	1/4	KRK06-02SW2	14				24	35				10
	3/8	KRK06-03SW2	17				25.4	36.5				33
8	1/8	KRK08-01SW2	12	15.2	12	20.5	21.1	37	20.5	19.7	21	13
	1/4	KRK08-02SW2	14				25.5	39				35
	3/8	KRK08-03SW2	17				26.9	41				31
10	1/8	KRK10-01SW2	17	18.5	17	24	23.1	42	23	30.9	23.2	25
	1/4	KRK10-02SW2					26.5	43.5				26
	3/8	KRK10-03SW2					27.9	45				36
	1/2	KRK10-04SW2					32.1	47.5				63
12	1/4	KRK12-02SW2	17	20.9	17	25	27	45.5	24	44.5	35.1	28
	3/8	KRK12-03SW2					28.4	47.5				38
	1/2	KRK12-04SW2					32.6	49.5				65

* Reference dimensions after R thread installation.

Note 1) øD1: Max. diameter

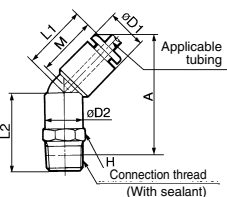

Universal Male Elbow: KRV-W2



Applicable tubing O.D. (mm)	Connection thread R	Model	H (width across flats)	(1)		L1	L2	L3	A*	M	Effective area (mm ²)		Weight (g)					
				øD1	øD2						FR double layer	FR soft nylon						
6	1/8	KRV06-01SW2	8	12.8	13.4	24	13.6	25.6	22.5	17	5.9	2.9	15					
	1/4	KRV06-02SW2	10										15.4	23.5	18	30.5	25	26
	3/8	KRV06-03SW2	12										17.6	28.5	14.6	27.6	24.5	24
8	1/4	KRV08-01SW2	12	15.2	17.6	28.5	18	31	25.5	18.5	16	11.2	30					
	3/8	KRV08-02SW2	14										20.6	27.5	19.4	35.4	30	47
	1/2	KRV08-03SW2	14										19	35	29.5	20.5	14.3	40
10	1/4	KRV10-02SW2	14	18.5	20.6	31	19	34	32	21	27	20.3	49					
	3/8	KRV10-03SW2	17										20.9	37.4	30	63		
	1/2	KRV12-04SW2	17										20.9	40.6	33.5	22	39	30.8

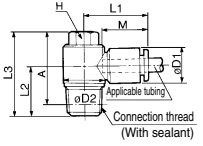

* Reference dimensions after R thread installation. Note 1) øD1: Max. diameter

Union Elbow: KRL-W2



Applicable tubing O.D. (mm)	Model	øD ⁽¹⁾	L	Q	M	Effective area (mm ²)		Weight (g)
						FR double layer	FR soft nylon	
6	KRL06-00W2	12.8	20	5.3	17	9.0	4.2	6
8	KRL08-00W2	15.2	23	6	18	21.6	14.9	10
10	KRL10-00W2	18.5	26.5	6.8	21	35.2	25.0	17
12	KRL12-00W2	20.9	28.5	7.5	22	50.2	39.7	21

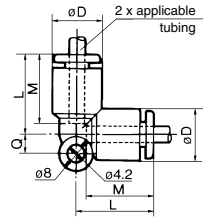

Note 1) øD: Max. diameter

Extended Male Elbow: KRW-W2



Applicable tubing O.D. (mm)	Connection thread R	Model	H (width across flats)	(1)		L1	L2	A*	M	Effective area (mm ²)		Weight (g)				
				øD1	øD2					FR double layer	FR soft nylon					
6	1/8	KRW06-01SW2	10	12.8	10	20	39.1	42.5	17	8.6	4.0	26				
	1/4	KRW06-02SW2	14									45.5	46.5	46.9	48	41
	3/8	KRW06-03SW2	17									46.9	48	42.6	47	67
8	1/4	KRW08-01SW2	12	15.2	12	23	49	51	18.5	20.5	14.2	30				
	3/8	KRW08-02SW2	14									50.4	52.5	57.4	61	47
	1/2	KRW08-03SW2	17									56	59.5	57.4	61	74
10	1/4	KRW10-02SW2	17	18.5	17	26.5	56	59.5	21	33.5	23.8	66				
	3/8	KRW10-03SW2	22									64.1	66	57	62	76
	1/2	KRW12-04SW2	22									64.1	66	65.1	68.5	145
12	1/4	KRW12-02SW2	17	20.9	17	28.5	58.4	63.5	22	47.7	37.7	68				
	3/8	KRW12-03SW2	22									65.1	68.5	65.1	68.5	147
	1/2	KRW12-04SW2	22									65.1	68.5	65.1	68.5	147

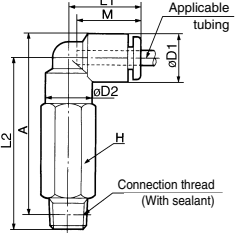

* Reference dimensions after R thread installation. Note 1) øD1: Max. diameter

Union Tee: KRT-W2



Applicable tubing O.D. (mm)	Model	øD ⁽¹⁾	L	Q	M	Effective area (mm ²)		Weight (g)
						FR double layer	FR soft nylon	
6	KRT06-00W2	12.8	20	5.3	17	10.6	6.4	10
8	KRT08-00W2	15.2	23	6	18.5	25.6	17.7	15
10	KRT10-00W2	18.5	26.5	6.8	21	40	28.4	25
12	KRT12-00W2	20.9	28.5	7.5	22	57.4	45.4	29

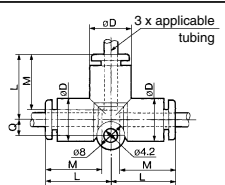

Note 1) øD: Max. diameter

Male Branch Tee: KRT-W2



Applicable tubing O.D. (mm)	Connection thread R	Model	H (width across flats)	(1)		L1	L2	A*	M	Effective area (mm ²)		Weight (g)				
				øD1	øD2					FR double layer	FR soft nylon					
6	1/8	KRT06-01SW2	10	12.8	10	20	22.1	25.5	17	11.0	6.0	12				
	1/4	KRT06-02SW2	14									26.5	27.5	27.9	29	30
	3/8	KRT06-03SW2	17									27.9	29	23.6	28	22
8	1/4	KRT08-01SW2	12	15.2	12	23	28	30	18.5	26.3	18.2	22				
	3/8	KRT08-02SW2	14									29.4	31.5	29.4	31.5	36
	1/2	KRT10-03SW2	17									26.1	32	29.5	33	31
10	1/4	KRT10-02SW2	17	18.5	17	26.5	30.9	34.5	21	40.8	29.0	39				
	3/8	KRT10-03SW2	22									35.1	37	35.1	37	66
	1/2	KRT12-02SW2	17									30.5	35.5	31.9	37	31
12	3/8	KRT12-03SW2	22	20.9	17	28.5	36.1	39.5	22	57.2	45.2	41				
	1/2	KRT12-04SW2	22									36.1	39.5	36.1	39.5	68

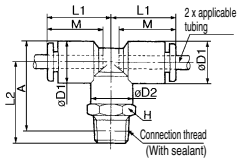

* Reference dimensions after R thread installation. Note 1) øD1: Max. diameter

KQ2

KQB2

KS
KX

KM

KF

M

H/DL
L/LL

KC

KK

KK130

DM

KDM

KB

KR

KA

KQG2

KG

KFG2

MS

KKA

KP

LQ

MQR

T

Series KR-W2

Male Run Tee: KRY-W2



Applicable tubing O.D. (mm)	Connection thread R	Model	H (width across flats)	(1)		L1	L2	A *	M	Effective area (mm ²)		Weight (g)
				øD1	øD2					FR double layer	FR soft nylon	
6	1/8	KRY06-01SW2	10	12.8	10	20	22.1	39	19	10.6	6.4	12
	1/4	KRY06-02SW2	14				26.5	41				20
	3/8	KRY06-03SW2	17				27.9	42.5				34
8	1/8	KRY08-01SW2	12	15.2	12	23	23.6	43.5	20.5	25.6	17.7	22
	1/4	KRY08-02SW2	14				28	44.5				24
	3/8	KRY08-03SW2	17				29.4	47				36
10	1/8	KRY10-01SW2	17	18.5	17	26.5	26.1	49.5	23	40.0	28.4	31
	1/4	KRY10-02SW2					29.5	50.5				29
	3/8	KRY10-03SW2					30.9	52				39
12	1/4	KRY12-02SW2	22	20.9	17	28.5	35.1	54.5	24	57.4	45.4	66
	3/8	KRY12-03SW2	17				30.5	53.5				31
	1/2	KRY12-04SW2	22				31.9	55				41

* Reference dimensions after R thread installation.

Note 1) øD: Max. diameter

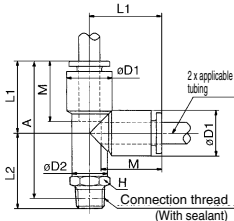

Branch: KRU-W2



Applicable tubing O.D. (mm)	Connection thread R	Model	H (width across flats)	(1) øD	L	P	A *	M	Effective area (mm ²)		Weight (g)			
									FR double layer	FR soft nylon				
6	1/8	KRU06-01SW2	13	12.8	44.6	12.8	43	17	10.4	4.2	12			
	1/4	KRU06-02SW2	14									48.5	43	22
	3/8	KRU06-03SW2	17									49.9	44.5	35
8	1/8	KRU08-01SW2	17	15.2	55	15.2	49.5	18.5	25.6	17.7	24			
	1/4	KRU08-02SW2										55.4	50	36
	3/8	KRU08-03SW2										60.5	55	30
10	1/4	KRU10-02SW2	19	18.5	60.9	18.5	55.5	21	40	28.4	40			
	3/8	KRU10-03SW2	17									64.1	57	65
	1/2	KRU10-04SW2	22									64	58.5	32
12	3/8	KRU12-03SW2	22	20.9	64.4	20.9	59	22	57.4	45.4	40			
	1/2	KRU12-04SW2	22									67.6	60.5	65

* Reference dimensions after R thread installation.

Note 1) øD: Max. diameter

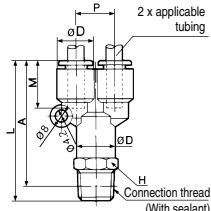

Union "Y": KRU-W2



Applicable tubing O.D. (mm)	Model	(1) øD	L1	L2	P	Q	M	Effective area (mm ²)		Weight (g)
								FR double layer	FR soft nylon	
6	KRU06-00W2	12.8	37	20	12.8	11.7	17	10.4	4.2	10
8	KRU08-00W2	15.2	42.5	24.5	15.2	13.7	18.5	25.6	17.7	12
10	KRU10-00W2	18.5	48	27.5	18.5	16.1	21	40	28.4	16
12	KRU12-00W2	20.9	51	30	20.9	18.1	22	57.4	45.4	23

Note 1) øD: Max. diameter

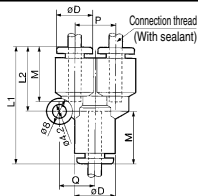

Plug-in "Y": KRU-W2



Applicable tubing O.D. (mm)	Applicable fitting size ød	Model	(1) øD	L1	L2	P	Q	A	M	Effective area (mm ²)		Weight (g)
										FR double layer	FR soft nylon	
6	6	KRU06-99W2	12.8	55.5	20	12.8	11.7	38.5	17	10.4	4.2	19
8	8	KRU08-99W2	15.2	64.5	24.5	15.2	13.7	46	18.5	25.6	17.7	22
10	10	KRU10-99W2	18.5	71.5	27.5	18.5	16.1	50.5	21	40	28.4	26
12	12	KRU12-99W2	20.9	75.5	30	20.9	18.1	53.5	22	57.4	45.4	32

Note 1) øD: Max. diameter

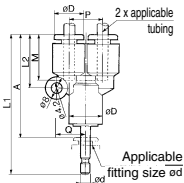

Plug-in Elbow: KRL-W2



Applicable tubing O.D. (mm)	Applicable fitting size ϕd	Model	⁽¹⁾			Effective area (mm ²)			Weight (g)		
			$\phi D1$	$\phi D2$	L ₁	L ₂	A	M		FR double layer	FR soft nylon
6	6	KRL06-99W2	12.8	10	20	27.5	17	9.0	4.2	3	
8	8	KRL08-99W2	15.2	12	22.5	31.5	21	18.5	21.6	14.9	5
10	10	KRL10-99W2	18.5	14	25.5	35.5	23.5	21	35.2	25.0	9
12	12	KRL12-99W2	20.9	16	27	37.5	26	22	50.2	39.7	10

Note 1) $\phi D1$: Max. diameter

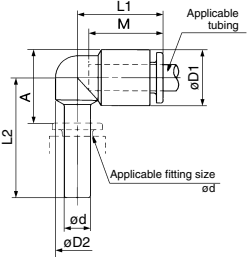

Extended Plug-in Elbow: KRW-W2



Applicable tubing O.D. (mm)	Applicable fitting size ϕd	Model	⁽¹⁾			Effective area (mm ²)			Weight (g)		
			$\phi D1$	$\phi D2$	L ₁	L ₂	A	M		FR double layer	FR soft nylon
6	6	KRW06-99W2	12.8	10	20	41.5	31	17	9.0	4.2	4
8	8	KRW08-99W2	15.2	10	22.5	48	37	18.5	21.6	14.9	6
10	10	KRW10-99W2	18.5	14	25.5	55	43.5	21	35.2	25.0	9
12	12	KRW12-99W2	20.9	16	27	59.5	48	22	50.2	39.7	13

Note 1) $\phi D1$: Max. diameter

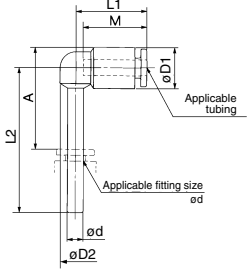

Plug-in Reducer: KRR-W2



Applicable tubing O.D. (mm)	Applicable fitting size ϕd	Model	⁽¹⁾ $\phi D1$	L	A	M	Effective area (mm ²)		Weight (g)	
							FR double layer	FR soft nylon	FR double layer	FR soft nylon
6	8	KRR06-08W2	12.8	37	18.5	17	10.4	5.6	2.5	
	10	KRR06-10W2		39.5					9.3	
	12	KRR06-12W2		41					4.0	
8	10	KRR08-10W2	15.2	42	20	18.5	26.1	18.0	4.6	
	12	KRR08-12W2		44.5					33	
10	12	KRR10-12W2	18.5	44.5	23	21	41.5	32.8	33	

Note 1) $\phi D1$: Max. diameter

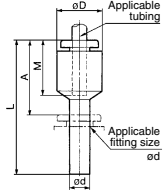

Bulkhead Union: KRE-W2



Applicable tubing O.D. (mm)	Model	T (M)	H (width across flats)	L	Mounting hole	M	Effective area (mm ²)		Weight (g)
							FR double layer	FR soft nylon	
6	KRE06-00W2	M14 x 1	17	34.5	15	17	10.4	5.6	33
8	KRE08-00W2	M16 x 1	19	38	17	18.5	26.1	18.0	52
10	KRE10-00W2	M20 x 1	24	42.5	21	21	41.5	29.5	70
12	KRE12-00W2	M22 x 1	27	44	23	22	58.3	46.1	90

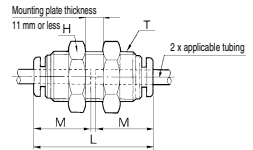

Bulkhead Connector: KRE-W2



Applicable tubing O.D. (mm)	Connection thread Rc	Model	T (M)	H1 (width across flats)	H2 (width across flats)	L ₁	L ₂	Mounting hole	M	Effective area (mm ²)		Weight (g)			
										FR double layer	FR soft nylon				
6	1/8	KRE06-01W2	M14 x 1	17	17	28	11	15	17	10.4	5.6	25			
	1/4	KRE06-02W2											31.5	15	40
	3/8	KRE06-03W2											33.5	17	29
8	1/8	KRE08-01W2	M16 x 1	17	19	27.5	7.5	17	18.5	26.1	18.0	28			
	1/4	KRE08-02W2											33	13	27
	3/8	KRE08-03W2											35	15	48
10	1/4	KRE10-02W2	M20 x 1	22	24	34.5	12.5	21	21	41.5	29.5	53			
	3/8	KRE10-03W2											36.5	15	67
	1/2	KRE10-04W2											37	14	92
12	3/8	KRE12-03W2	M22 x 1	24	27	37	14	23	22	58.3	46.1	92			
	1/2	KRE12-04W2											41	18	59

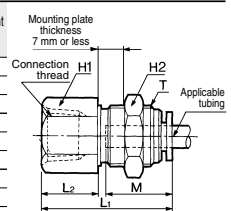

- KQ2
- KQB2
- KS
- KX
- KM
- KF
- M
- H/DL
- L/LL
- KC
- KK
- KK130
- DM
- KDM
- KB
- KR
- KA
- KQG2
- KG
- KFG2
- MS
- KKA
- KP
- LQ
- MQR
- T

Series KR-W2

Plug: KRP



Applicable fitting size ϕD	Model	ϕD	L	A	Weight (g)
6	KRP-06	8	35	18	1
8	KRP-08	10	39	20.5	2
10	KRP-10	12	43	22	3.5
12	KRP-12	14	45.5	24	5

* Color: Green

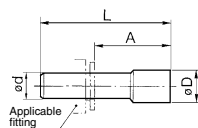

Spatter Cover 1: KR (Applicable tube: FR soft nylon)



Applicable fitting size	Model	ϕD	L	Weight (g)
6	KR-06C	15.5	9	0.9
8	KR-08C	17	9	1.0
10	KR-10C	20.8	10.5	1.5
12	KR-12C	22.8	10.5	1.6

* When tube insert parts are in line as KQU Union "Y", use KR-□□C1.

* Color: Gray

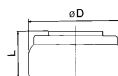

Spatter Cover 2: KR (Applicable tube: FR soft nylon, FR double layer)



Applicable fitting size	Model	L ₁	L ₂	ϕD
6	KR-06C1	18	13.7	12.8
8	KR-08C1	20	15.7	15
10	KR-10C1	22	17.2	18
12	KR-12C1	22	17.2	20

* Color: Gray

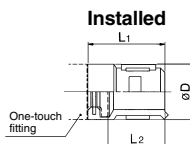

How to install

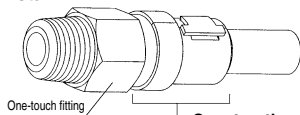

Construction of spatter cover

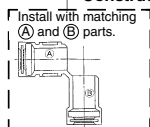

Install with matching (A) and (B) parts.