

Electrical Interconnection

Supplementary Catalog to Full Line Catalogs, Volumes 1/2/5/6

Edition 2019/1



WAGO Rail-Mounted Terminal Block Systems 1
Full Line Catalog, Volume 1 – Edition 2019/2020

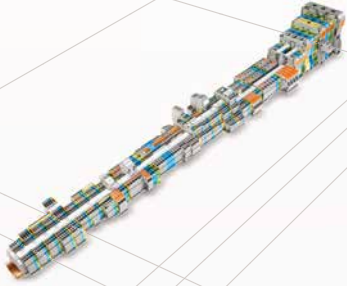

WAGO PCB Terminal Blocks and WAGO Connectors 2
Full Line Catalog, Volume 2 – Edition 2019/2020



Automation Technology 3
Full Line Catalog, Volume 3 – Edition 2019/2020



WAGO Electronic Interface 4
Full Line Catalog, Volume 4 – Edition 2019/2020

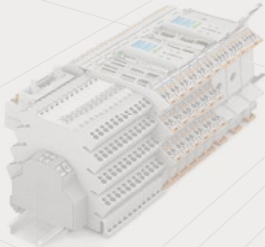

WAGO Pluggable Connection System WINSTA® 5
Full Line Catalog, Volume 5 – Edition 2019/2020



WAGO Marking 6
Full Line Catalog, Volume 6 – Edition 2019/2020





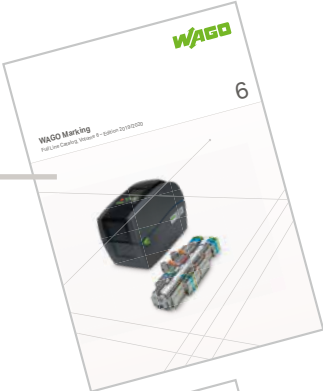
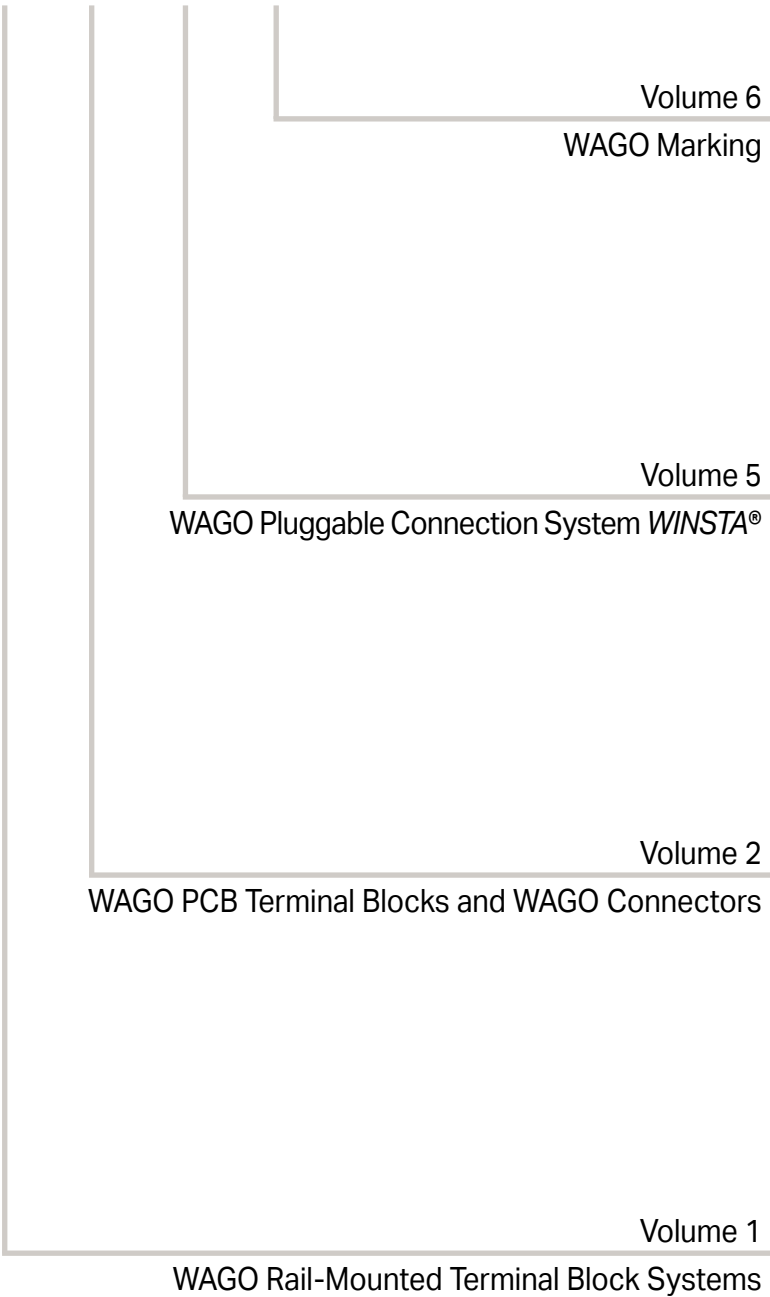

The new items in this catalog supplement products found in the following main catalogs

N 1/2/5/6







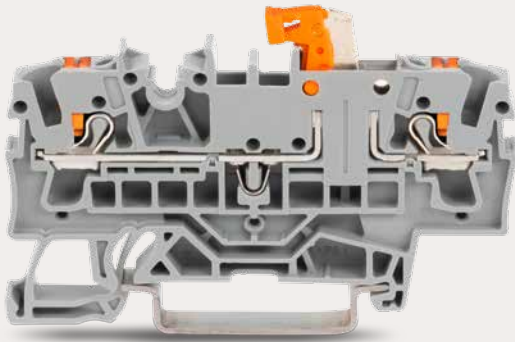
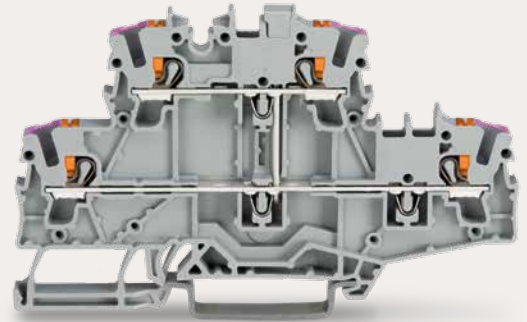
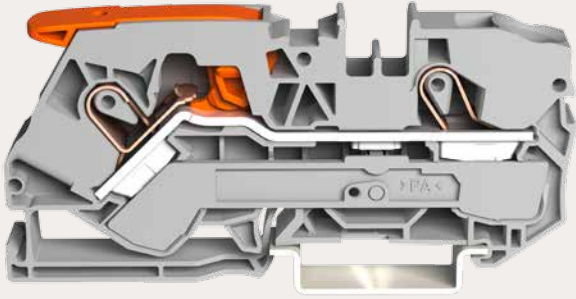

Supplementary Catalog Electrical Interconnection

	WAGO Rail-Mount Terminal Block Systems	Volume 1	4
	WAGO PCB Terminal Blocks and WAGO Connectors	Volume 2	26
	WAGO Marking Accessories	Volume 6	52
	WAGO Tools		56
	Item Number Index		62

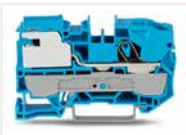
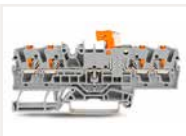
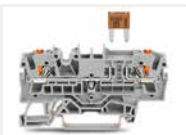

Volume 1, WAGO Rail-Mount Terminal Block Systems

Volume 1, WAGO Rail-Mount Terminal Block Systems

		Page
	Through and Ground Conductor Terminal Blocks TOPJOB® S; with Lever and Push-in CAGE CLAMP® 10 (16) mm² / 6 AWG	2110 Series 4
	Double-Deck Terminal Blocks TOPJOB® S; with Push-Button; with Vertical Conductor Entry; 2.5 (4) mm² / 12 AWG	2202 Series 6
	N-Conductor and Power Distribution Disconnect Terminal Blocks TOPJOB® S 10 (16) mm² / 6 AWG	2010 Series 7
	Test/Disconnect Terminal Blocks; Through and Ground Conductor Terminal Blocks TOPJOB® S; with Push-Button; with Additional Jumper Slot 2.5 (4) mm² / 12 AWG	2202 Series 8
	Fuse Terminal Blocks TOPJOB® S; with Push-Button; for Mini-Automotive Blade-Style Fuses 2.5 (4) mm² / 12 AWG	2202 Series 14
	Fused Disconnect Terminal Blocks with a Pivoting Fuse Holder TOPJOB® S; with Push-Button; for Glass Cartridge Fuses 5 x 20 mm 2.5 (4) mm² / 12 AWG	2202 Series 16
	2-Pin Carrier Terminal Block and 4-Pin Carrier Terminal Block X-COM®S-SYSTEM 2.5 (4) mm² / 12 AWG	2022 Series 23
	COMPACT Splicing Connectors for All Conductor Types and Mounting Carrier; for Ex eb Applications 4 mm² / 12 AWG	221 Series 25

PUSH-IN CAGE CLAMP®

Through and Ground Conductor Terminal Block TOPJOB® S; with Lever and Push-in CAGE CLAMP® 10 (16) mm²; 2110 Series

Technical Data	
0.5 ... 10 (16) mm² ❶	20 ... 6 AWG
800 V/8 kV/3 ❷	
I _N 57 A	
Terminal block width: 10 mm / 0.394 inch	
 17 ... 19 mm / 0.67 ... 0.91 inch	

Technical Data	
0.5 ... 10 (16) mm² ❶	20 ... 6 AWG
800 V/8 kV/3 ❷	
I _N 57 A	
Terminal block width: 10 mm / 0.394 inch	
 17 ... 19 mm / 0.67 ... 0.91 inch	

❶ Conductor range: 0.5 ... 16 mm² "s+f-st"
Push-in termination: 4 ... 16 mm² "s" and 4 ... 10 mm² "insulated ferrules, 18 mm"
Depending on the conductor characteristic, a conductor with a smaller cross section can also be inserted via push-in termination.

❷ 800 V = rated voltage
8 kV = rated impulse voltage
3 = pollution degree
(see Full Line Catalog, Volume 1, Section 14)

❸ Terminal blocks with a blue insulated housing are suitable for Ex i applications.

See application notes in our Full Line Catalog, Volume 1. Jumpers, from page 155
Testing accessories, from page 148
Marking accessories, from page 588

Approvals and corresponding ratings, visit www.wago.com

Available July 2019

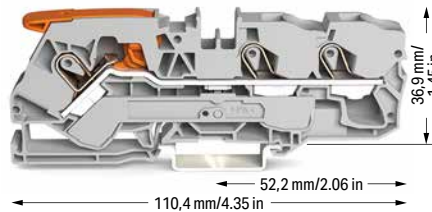
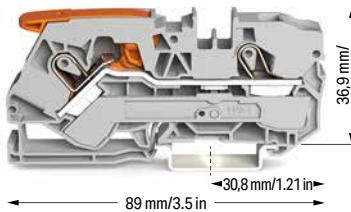

2-conductor through terminal block; with lever and Push-in CAGE CLAMP®

Color	Item No.	Pack. Unit
gray	2110-1201	25
blue	2110-1204 ❸	25

3-conductor through terminal block; with lever and Push-in CAGE CLAMP®

Color	Item No.	Pack. Unit
gray	2110-1301	25
blue	2110-1304 ❸	25

2-conductor ground terminal block; with lever and Push-in CAGE CLAMP®

Color	Item No.	Pack. Unit
green-yellow	2110-1207	25

3-conductor ground terminal block; with lever and Push-in CAGE CLAMP®

Color	Item No.	Pack. Unit
green-yellow	2110-1307	25

Item-Specific Accessories

End and intermediate plate; 1 mm thick

orange	2110-1292	100 (25)
gray	2110-1291	100 (25)

Item-Specific Accessories

End and intermediate plate; 1 mm thick

orange	2110-1392	100 (25)
gray	2110-1391	100 (25)

Accessories; 2110 Series

Appropriate marking systems: WMB/WMB Inline/Marking strips

Push-in type jumper bar; insulated; I_N 57 A; light gray

	2-way	2010-402	25
	3-way	2010-403	25
	4-way	2010-404	25
	5-way	2010-405	25

Finger guard; touch-proof cover protects unused conductor entries

	yellow	2010-100	100 (25)
---	--------	----------	----------

Push-in type jumper bar; insulated; I_N 57 A; light gray

	1 to 3	2010-433	25
	1 to 4	2010-434	25
	1 to 5	2010-435	25

Modular connector; snaps together; for jumper contact slot

	gray	2010-511	50 (25)
---	------	----------	---------

Star point jumper; insulated; I_N = I_N terminal block; light gray

	1-3-5	2010-405/011-000	25
--	-------	------------------	----

Test plug adapter; for 4 mm Ø test plug

	gray	2009-174	100 (25)
---	------	----------	----------

Protective warning marker; with black high-voltage symbol; for 5 terminal blocks

	yellow	2010-115	100 (25)
--	--------	----------	----------

Marking strip; plain; 11 mm wide; 50 m reel

	white	2009-110	1
---	-------	----------	---

WMB marker card; white; 10 strips with 10 markers/card; stretchable 5 ... 5.2 mm

	plain	793-5501	5
---	-------	----------	---

Through and Ground Conductor Terminal Block TOPJOB® S; with Lever and Push-Button 10 (16) mm²; 2110 Series

Technical Data

0.5 ... 10 (16) mm² ① | 20 ... 6 AWG

800 V/8 kV/3 ②

I_N 57 A

Terminal block width: 10 mm / 0.394 inch

 17 ... 19 mm / 0.67 ... 0.91 inch

Technical Data

0.5 ... 10 (16) mm² ① | 20 ... 6 AWG

800 V/8 kV/3 ②

I_N 57 A

Terminal block width: 10 mm / 0.394 inch

 17 ... 19 mm / 0.67 ... 0.91 inch

Available July 2019

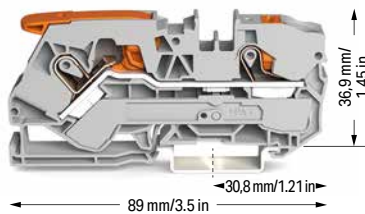

2-conductor through terminal block; with lever and push-button

Color	Item No.	Pack. Unit
gray	2110-5201	25
blue	2110-5204 ③	25

3-conductor through terminal block; with lever and push-button

Color	Item No.	Pack. Unit
gray	2110-5301	25
blue	2110-5304 ③	25

2-conductor ground terminal block; with lever and Push-in CAGE CLAMP®

green-yellow	2110-5207	25
--------------	-----------	----

3-conductor ground terminal block; with lever and Push-in CAGE CLAMP®

green-yellow	2110-5307	25
--------------	-----------	----

Item-Specific Accessories

End and intermediate plate; 1 mm thick

orange	2110-1292	100 (25)
gray	2110-1291	100 (25)

Item-Specific Accessories

End and intermediate plate; 1 mm thick

orange	2110-1392	100 (25)
gray	2110-1391	100 (25)

Accessories; 2110 Series

Appropriate marking systems: WMB/WMB Inline/Marking strips

Push-in type jumper bar; insulated; I_N 57 A; light gray

	2-way	2010-402	25
	3-way	2010-403	25
	4-way	2010-404	25
	5-way	2010-405	25

Push-in type jumper bar; insulated; I_N 57 A; light gray

	1 to 3	2010-433	25
	1 to 4	2010-434	25
	1 to 5	2010-435	25

Star point jumper; insulated; I_N = I_N terminal block; light gray

	1-3-5	2010-405/011-000	25
---	-------	------------------	----

Finger guard; touch-proof cover protects unused conductor entries

	yellow	2010-100	100 (25)
---	--------	----------	----------

Modular connector; snaps together; for jumper contact slot

	gray	2010-511	50 (25)
---	------	----------	---------

Test plug adapter; for 4 mm Ø test plug

	gray	2009-174	100 (25)
---	------	----------	----------

Marking strip; plain; 11 mm wide; 50 m reel

	white	2009-110	1
---	-------	----------	---

WMB marker card; white; 10 strips with 10 markers/card; stretchable 5 ... 5.2 mm

	plain	793-5501	5
---	-------	----------	---

① Conductor range: 0.5 ... 16 mm² "s+f-st"
Push-in termination: 4 ... 16 mm² "s" and 4 ... 10 mm² "insulated ferrules, 18 mm"
Depending on the conductor characteristic, a conductor with a smaller cross section can also be inserted via push-in termination.

② 800 V = rated voltage
8 kV = rated impulse voltage
3 = pollution degree
(see Full Line Catalog, Volume 1, Section 14)

③ Terminal blocks with a blue insulated housing are suitable for Ex i applications.

See application notes in our Full Line Catalog, Volume 1. Jumpers, from page 155
Testing accessories, from page 148
Marking accessories, from page 588

Approvals and corresponding ratings, visit www.wago.com

Double-Deck Terminal Block TOPJOB® S; with Push-Button; with Vertical Conductor Entry 2.5 (4) mm²; 2202 Series

Technical Data	
0.25 ... 2.5 (4) mm ² ①	22 ... 12 AWG
800 V/8 kV/3 ②	
I _N 24 A	
Terminal block width: 5.2 mm / 0.205 inch	
 10 ... 12 mm / 0.39 ... 0.47 inch	

Technical Data	
0.25 ... 2.5 (4) mm ² ①	22 ... 12 AWG
800 V/8 kV/3 ②	
I _N 24 A	
Terminal block width: 5.2 mm / 0.205 inch	
 10 ... 12 mm / 0.39 ... 0.47 inch	

- ① Conductor range: 0.25 ... 4 mm² "s+f-st"
Push-in termination: 1 ... 4 mm² "s" and 1 ... 2.5 mm² "insulated ferrules, 12 mm"
Depending on the conductor characteristic, a conductor with a smaller cross section can also be inserted via push-in termination.
 - ② 800 V = rated voltage
8 kV = rated impulse voltage
3 = pollution degree
(see Full Line Catalog, Volume 1, Section 14)
 - ③ Terminal blocks with a blue insulated housing are suitable for Ex i applications.
- See application notes in our Full Line Catalog, Volume 1. Jumpers, from page 157
Testing accessories, from page 151
Marking accessories, from page 588
- Approvals and corresponding ratings, visit www.wago.com

Available May 2019

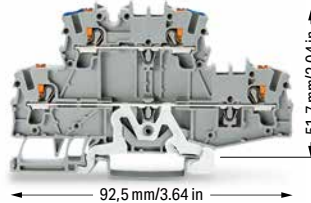
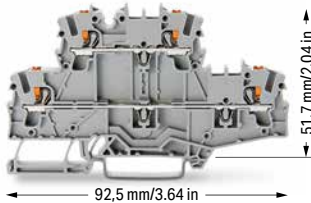

Double-deck terminal block; with push-button; Through/through terminal block; with vertical conductor entry; without marker carrier; Gray housing



	Item No.	Pack. Unit
○ L/L	2202-2701	50
○ N/L	2202-2702	50
○ L/N	2202-2703	50

Double-deck terminal block; with push-button; Ground conductor/through terminal block; with vertical conductor entry; without marker carrier; Gray housing

	Item No.	Pack. Unit
○ GND/N	2202-2717	50
○ GND/L	2202-2727	50

Accessories; 2202 Series

Appropriate marking systems:
WMB/WMB Inline/Marking strips

End and intermediate plate; 0.8 mm thick		
	orange	2202-2792 100 (25)
	gray	2202-2791 100 (25)

Double-deck terminal block; with push-button; Through/through terminal block; with vertical conductor entry; without marker carrier; Blue housing

● N/N	2202-2704 ③	50
-------	-------------	----

Double-deck marker carrier; pivoting

	gray	2002-121	50 (25)
--	------	----------	---------

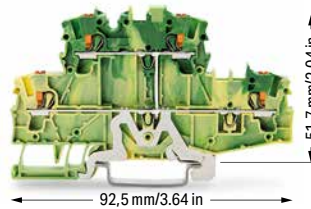
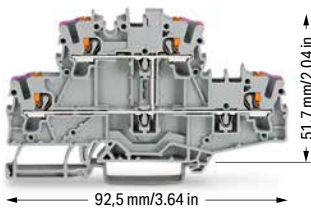

Insulation stop; 5 pcs/strip; 0.25 ... 0.5 mm²

	light gray	2002-171	200 (25)
---	------------	----------	----------

Insulation stop; 5 pcs/strip; 0.75 ... 1 mm²

	dark gray	2002-172	200 (25)
---	-----------	----------	----------

Double-deck terminal block; with push-button; 4-conductor through terminal block; with vertical conductor entry; without marker carrier; Internally commoned; Violet conductor entry; Gray housing

	Item No.	Pack. Unit
○ L	2202-2708	50

Double-deck terminal block; with push-button; 4-conductor ground terminal block; with vertical conductor entry; without marker carrier; Internally commoned; Green-yellow housing

	Item No.	Pack. Unit
● GND	2202-2707	50

Push-in type jumper bar; insulated; I_N 25 A; light gray

	2-way	2002-402	25
	3-way	2002-403	25
	4-way	2002-404	25
	5-way	2002-405	25
	6-way	2002-406	25
	7-way	2002-407	25
	8-way	2002-408	25
	9-way	2002-409	25
	10-way	2002-410	25

Double-deck terminal block; with push-button; 4-conductor through terminal block; with vertical conductor entry; without marker carrier; Internally commoned; Violet conductor entry; Blue housing

● N	2202-2709 ③	50
-----	-------------	----

Push-in type jumper bar; insulated; I_N 25 A; light gray

	1 to 3	2002-433	25
	1 to 4	2002-434	25
	1 to 5	2002-435	25
	1 to 6	2002-436	25
	1 to 7	2002-437	25
	1 to 8	2002-438	25
	1 to 9	2002-439	25
	1 to 10	2002-440	25

Double-deck vertical jumper; insulated; I_N 24 A

	light gray	2002-492	100 (25)
	orange	2002-492/000-012	100 (25)

N-Disconnect Terminal Block and Power Distribution Disconnect Terminal Block TOPJOB® S

10 (16) mm²; 2010 Series

Technical Data

0.5 ... 10 (16) mm² ① | 20 ... 6 AWG

250 V/4 kV/3 ②

I_N 57 A

Terminal block width: 10 mm / 0.394 inch

 17 ... 19 mm / 0.67 ... 0.91 inch

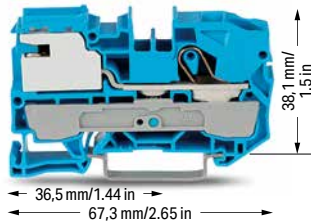

1-conductor N-disconnect terminal block

Color	Item No.	Pack. Unit
blue	2010-7114	25

1-conductor power distribution disconnect terminal block

gray	2010-7111	25
------	-----------	----

Appropriate through and ground conductor terminal blocks, see Full Line Catalog, Volume 1, page 57

Accessories; for N-Conductor and Power Distribution Disconnect Terminal Blocks

Appropriate marking systems:
WMB/WMB Inline/Marking strips

End and intermediate plate; 1 mm thick

orange	2010-7192	100 (25)
--------	-----------	----------



Lock-out; prevents reclosing of slide link; snap-on type

orange	2006-7300	100 (25)
--------	-----------	----------



Busbar carrier; not suitable as an end stop; snaps onto DIN-35 rail; 1.5 mm thick

blue	2009-304	100 (25)
------	----------	----------



Busbar carrier; with end stop function and detachable separator plate; snaps onto DIN-35 rail; 7.5 mm thick

blue	2009-305	25
------	----------	----



Busbar; tin-plated; 1000 mm long; copper (10 x 3) mm

I _N 140 A	210-133	1
----------------------	---------	---



Busbar cover; 1000 mm long

transparent	777-303	1
-------------	---------	---



- Conductor range: 0.5 ... 16 mm² "s+f-st"
Push-in termination: 4 ... 16 mm² "s" and 4 ... 10 mm² "insulated ferrules, 18 mm"
Depending on the conductor characteristic, a conductor with a smaller cross section can also be inserted via push-in termination.
- 250 V = rated voltage
4 kV = rated impulse voltage
3 = pollution degree
(see Full Line Catalog, Volume 1, Section 14)

Approvals and corresponding ratings, visit www.wago.com

Accessories; for N-Conductor and Power Distribution Disconnect Terminal Blocks

Appropriate marking systems:
WMB/WMB Inline/Marking strips

Connector; for busbar; 2.5 ... 35 mm²

unplated	209-105	1
----------	---------	---



Connector; for busbar; with blue cover; 2.5 ... 16 mm²

blue	210-281	100 (50)
------	---------	----------



Test plug; with 500 mm cable; 2 mm Ø; max. 42 V

red	210-136	50
-----	---------	----



Test plug; with 500 mm cable; 2.3 mm Ø; max. 42 V

	210-137	50
--	---------	----



Marking strip; plain; 11 mm wide; 50 m reel

white	2009-110	1
-------	----------	---



WMB marker card; white; 10 strips with 10 markers/card; stretchable 5 ... 5.2 mm

plain	793-5501	5
-------	----------	---



N-Conductor Disconnect Terminal Blocks

For the construction and operation of power installations in fire-prone, hazardous locations or public buildings – such as conference centers, stores, hospitals, schools, theaters or hotels – the DIN VDE 0100-710 or DIN VDE 0100-718 standards shall be observed. DIN VDE 0100-482 shall also be observed for fire-prone, hazardous locations. These VDE regulations mandate that every neutral conductor must be provided with a disconnection device so, e.g., insulation testing is possible for every circuit without disconnecting the N-conductor. WAGO's N-disconnect terminal blocks meet this requirement.

Power Distribution Disconnect Terminal Blocks

According to DIN VDE 0100-710, "Requirements for operating facilities, rooms and special installations – medical facilities," equipotential bonding conductors shall be run on a potential equalization busbar. The potential equalization busbar and the protective ground conductor busbar must be mounted in a common housing and be connected to each other using a disconnectable copper conductor of minimum 16 mm² (6 AWG). Furthermore, all equipotential bonding conductors must be connected to the potential equalization busbar and clearly arranged so they can be disconnected individually and accessed at any time. Depending on their function, they must be provided with captive marking. WAGO's power distribution disconnect terminal blocks meet these requirements.

Disconnect/Test Terminal Block and Through Terminal Block TOPJOB® S; with Push-Button 2.5 (4) mm²; 2202 Series



Technical Data	
0.25 ... 2.5 (4) mm ² ①	22 ... 12 AWG
400 V/6 kV/3 ②	
I _N 16 A	
Terminal block width: 5.2 mm / 0.205 inch	
 10 ... 12 mm / 0.39 ... 0.47 inch	

Technical Data	
0.25 ... 2.5 (4) mm ² ①	22 ... 12 AWG
400 V/6 kV/3 ②	
I _N 16 A	
Terminal block width: 5.2 mm / 0.205 inch	
 10 ... 12 mm / 0.39 ... 0.47 inch	

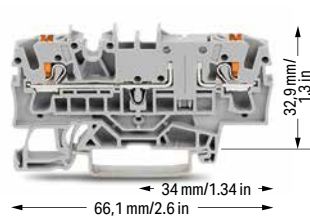
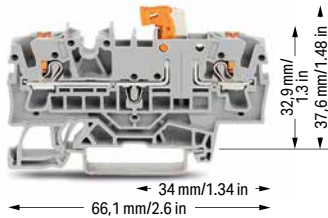

Available June 2019



2-conductor disconnect/test terminal block; with push-button; with test point; Orange disconnect link

Color	Item No.	Pack. Unit
 gray	2202-1671	50
 blue	2202-1674	50
 orange	2202-1672	50

2-conductor through terminal block; with push-button; with test point; Same profile as 2-conductor disconnect terminal block

Color	Item No.	Pack. Unit
 gray	2202-1601	50
 blue	2202-1604	50
 orange	2202-1602	50

Other terminal blocks with the same profile		
Fuse	2202-1681	Page 14
Carrier; gray	2202-1661	
Carrier; orange	2202-1662	

① Conductor range: 0.25 ... 2.5 mm² "s+f-st" and 0.25 ... 4 mm² "s"; Push-in termination: 1 ... 4 mm² "s" and 1 ... 2.5 mm² "insulated ferrules, 12 mm" Depending on the conductor characteristic, a conductor with a smaller cross section can also be inserted via push-in termination.

② 400 V = rated voltage
6 kV = rated impulse voltage
3 = pollution degree
(see Full Line Catalog, Volume 1, Section 14)

See application notes in our Full Line Catalog, Volume 1. Jumpers, from page 152
Testing accessories, from page 146
Marking accessories, from page 588

Approvals and corresponding ratings, visit www.wago.com

Accessories; 2202 Series

Appropriate marking systems: WMB/WMB Inline/Marking strips

Customized staggered jumper; insulated; with contact lugs broken off at the factory and circuit printing; I_N 25 A; light gray

	1-3	2002-473/011-000	25
	1-3-5	2002-475/011-000	25
	1-3-5-7	2002-477/011-000	25
	1-3-5-7-9	2002-479/011-000	25
	1-3-5-7-9-11	2002-481/011-000	25

Adjacent jumper for continuous commoning; insulated; I_N 25 A; light gray

	2-way	2002-400	25
---	-------	----------	----

Adjacent jumper for continuous commoning; insulated; I_N 25 A; 1 to 3

	light gray	2002-423	25
	red	2002-423/000-005	25
	blue	2002-423/000-006	25

Modular connector; snaps together; for jumper contact slot

	gray	2002-511	100 (25)
---	------	----------	----------

Spacer module; snaps together; bridges commoned terminal blocks

	gray	2002-549	100 (25)
---	------	----------	----------

End plate; for modular connector; 1.5 mm thick

	gray	2002-541	100 (25)
---	------	----------	----------

Accessories; 2202 Series

Appropriate marking systems: WMB/WMB Inline/Marking strips

End and intermediate plate; 1 mm thick

	orange	2002-1692	100 (25)
	gray	2002-1691	100 (25)

Insulation stop; 5 pcs/strip; 0.25 ... 0.5 mm²

	light gray	2002-171	200 (25)
---	------------	----------	----------

Insulation stop; 5 pcs/strip; 0.75 ... 1 mm²

	dark gray	2002-172	200 (25)
---	-----------	----------	----------

Protective warning marker; with black high-voltage symbol; for 5 terminal blocks

	yellow	2002-115	100 (25)
---	--------	----------	----------

Push-in type jumper bar; insulated; I_N 25 A; light gray

	2-way	2002-402	25
	3-way	2002-403	25
	4-way	2002-404	25
	5-way	2002-405	25
	6-way	2002-406	25
	7-way	2002-407	25
	8-way	2002-408	25
	9-way	2002-409	25
	10-way	2002-410	25

Push-in type wire jumper; insulated; 1.5 mm² conductor cross section; I_N 18 A

	L = 60 mm	2009-412	100 (10)
	L = 110 mm	2009-414	100 (10)
	L = 250 mm	2009-416	100 (10)

Push-in type jumper bar; insulated; I_N 25 A; light gray

	1 to 3	2002-433	25
	1 to 4	2002-434	25
	1 to 5	2002-435	25
	1 to 6	2002-436	25
	1 to 7	2002-437	25
	1 to 8	2002-438	25
	1 to 9	2002-439	25
	1 to 10	2002-440	25

Delta jumper; insulated; I_N = I_N terminal block; light gray

	1-2 3-4 5-6	2002-406/020-000	25
---	-------------	------------------	----

Star point jumper; insulated; I_N = I_N terminal block; light gray

	1-3-5	2002-405/011-000	25
---	-------	------------------	----

Staggered jumper; insulated; I_N 25 A; light gray

	2-way	2002-472	25
	3-way	2002-473	25
	4-way	2002-474	25
	5-way	2002-475	25
	6-way	2002-476	25
	7-way	2002-477	25
	8-way	2002-478	25
	9-way	2002-479	25
	10-way	2002-480	25
	11-way	2002-481	25
	12-way	2002-482	25

Accessories; 2202 Series

Appropriate marking systems:
WMB/WMB Inline/Marking strips

L-type test plug module; snaps together

gray 2002-611 100 (25)

L-type spacer module; snaps together; bridges commoned terminal blocks,

gray 2002-649 100 (25)

End plate; for modular test plug module; 1.5 mm thick

gray 2002-641 100 (25)

Test plug adapter; for 4 mm Ø test plug

gray 2009-174 100 (25)

Banana plug; for 4 mm socket diameter; color mixed; 10 x orange, white, black, blue, yellow; max. 42 V

215-111 50

Testing tap; for max. 2.5 mm²

gray 2009-182 100 (25)

WMB Inline; plain; 1,500 WMB markers (5 mm)/reel; stretchable 5 ... 5.2 mm

white 2009-115 1

Marking strip; plain; 11 mm wide; 50 m reel

white 2009-110 1

WMB marker card; white; 10 strips with 10 markers/card; stretchable 5 ... 5.2 mm

plain 793-5501 5

Double-deck marker carrier; pivoting

gray 2002-121 50 (25)

Disconnect/Test Terminal Block; Through Terminal Block and Ground Conductor Terminal Block TOPJOB® S; with Push-Button; with Additional Jumper Slot

2.5 (4) mm²; 2202 Series



Technical Data	
0.25 ... 2.5 (4) mm ² ①	22 ... 12 AWG
400 V/6 kV/3 ②	
I _N 16 A	
Terminal block width: 5.2 mm / 0.205 inch	
 10 ... 12 mm / 0.39 ... 0.47 inch	

Technical Data	
0.25 ... 2.5 (4) mm ² ①	22 ... 12 AWG
400 V/6 kV/3 ②	
I _N 16 A	
Terminal block width: 5.2 mm / 0.205 inch	
 10 ... 12 mm / 0.39 ... 0.47 inch	

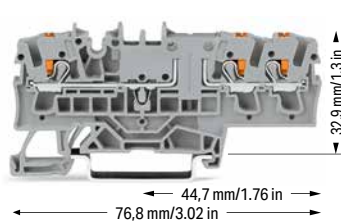
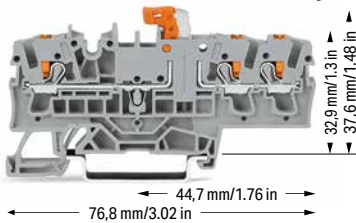

Available June 2019



3-conductor disconnect/test terminal block; with push-button; with test point; Orange disconnect link

Color	Item No.	Pack. Unit
 gray	2202-1771	50
 blue	2202-1774	50
 orange	2202-1772	50

3-conductor through terminal block; with push-button; with test point; Same profile as 3-conductor disconnect terminal block

Color	Item No.	Pack. Unit
 gray	2202-1701	50
 blue	2202-1704	50
 orange	2202-1702	50

3-conductor ground terminal block; with push-button

 green-yellow	2202-1707	50
---	-----------	----

Other terminal blocks with the same profile

Fuse	2202-1781	Page 14
Carrier	2202-1761	

① Conductor range: 0.25 ... 2.5 mm² "s+f-st" and 0.25 ... 4 mm² "s"; Push-in termination: 1 ... 4 mm² "s" and 1 ... 2.5 mm² "insulated ferrules, 12 mm" Depending on the conductor characteristic, a conductor with a smaller cross section can also be inserted via push-in termination.

② 400 V = rated voltage
6 kV = rated impulse voltage
3 = pollution degree
(see Full Line Catalog, Volume 1, Section 14)

See application notes in our Full Line Catalog, Volume 1. Jumpers, from page 152
Testing accessories, from page 146
Marking accessories, from page 588

Approvals and corresponding ratings, visit www.wago.com

Accessories; 2202 Series

Appropriate marking systems: WMB/WMB Inline/Marking strips

Customized staggered jumper; insulated; with contact lugs broken off at the factory and circuit printing; I_N 25 A; light gray

	1-3	2002-473/011-000	25
	1-3-5	2002-475/011-000	25
	1-3-5-7	2002-477/011-000	25
	1-3-5-7-9	2002-479/011-000	25
	1-3-5-7-9-11	2002-481/011-000	25

Adjacent jumper for continuous commoning; insulated; I_N 25 A; light gray

	2-way	2002-400	25
---	-------	----------	----

Adjacent jumper for continuous commoning; insulated; I_N 25 A; 1 to 3

	light gray	2002-423	25
	red	2002-423/000-005	25
	blue	2002-423/000-006	25

Modular connector; snaps together; for jumper contact slot

	gray	2002-511	100 (25)
---	------	----------	----------

End plate; for modular connector; 1.5 mm thick

	gray	2002-541	100 (25)
---	------	----------	----------

Accessories; 2202 Series

Appropriate marking systems: WMB/WMB Inline/Marking strips

End and intermediate plate; 1 mm thick

	orange	2002-1792	100 (25)
	gray	2002-1791	100 (25)

Insulation stop; 5 pcs/strip; 0.25 ... 0.5 mm²

	light gray	2002-171	200 (25)
--	------------	----------	----------

Insulation stop; 5 pcs/strip; 0.75 ... 1 mm²

	dark gray	2002-172	200 (25)
--	-----------	----------	----------

Protective warning marker; with black high-voltage symbol; for 5 terminal blocks

	yellow	2002-115	100 (25)
--	--------	----------	----------

Push-in type jumper bar; insulated; I_N 25 A; light gray

	2-way	2002-402	25
	3-way	2002-403	25
	4-way	2002-404	25
	5-way	2002-405	25
	6-way	2002-406	25
	7-way	2002-407	25
	8-way	2002-408	25
	9-way	2002-409	25
	10-way	2002-410	25

Push-in type wire jumper; insulated; 1.5 mm² conductor cross section; I_N 18 A

	L = 60 mm	2009-412	100 (10)
	L = 110 mm	2009-414	100 (10)
	L = 250 mm	2009-416	100 (10)

Push-in type jumper bar; insulated; I_N 25 A; light gray

	1 to 3	2002-433	25
	1 to 4	2002-434	25
	1 to 5	2002-435	25
	1 to 6	2002-436	25
	1 to 7	2002-437	25
	1 to 8	2002-438	25
	1 to 9	2002-439	25
	1 to 10	2002-440	25

Delta jumper; insulated; I_N = I_N terminal block; light gray

	1-2 3-4 5-6	2002-406/020-000	25
---	-------------	------------------	----

Star point jumper; insulated; I_N = I_N terminal block; light gray

	1-3-5	2002-405/011-000	25
---	-------	------------------	----

Staggered jumper; insulated; I_N 25 A; light gray

	2-way	2002-472	25
	3-way	2002-473	25
	4-way	2002-474	25
	5-way	2002-475	25
	6-way	2002-476	25
	7-way	2002-477	25
	8-way	2002-478	25
	9-way	2002-479	25
	10-way	2002-480	25
	11-way	2002-481	25
	12-way	2002-482	25

Accessories; 2202 Series

Appropriate marking systems:
WMB/WMB Inline/Marking strips

L-type test plug module; snaps together

gray 2002-611 100 (25)

L-type spacer module; snaps together; bridges commoned terminal blocks,

gray 2002-649 100 (25)

End plate; for modular test plug module; 1.5 mm thick

gray 2002-641 100 (25)

Test plug adapter; for 4 mm Ø test plug

gray 2009-174 100 (25)

Banana plug; for 4 mm socket diameter; color mixed; 10 x orange, white, black, blue, yellow; max. 42 V

215-111 50

Testing tap; for max. 2.5 mm²

gray 2009-182 100 (25)

WMB Inline; plain; 1,500 WMB markers (5 mm)/reel; stretchable 5 ... 5.2 mm

white 2009-115 1

Marking strip; plain; 11 mm wide; 50 m reel

white 2009-110 1

WMB marker card; white; 10 strips with 10 markers/card; stretchable 5 ... 5.2 mm

plain 793-5501 5

Double-deck marker carrier; pivoting

gray 2002-121 50 (25)

Disconnect/Test Terminal Block and Through Terminal Block TOPJOB® S; with Push-Button 2.5 (4) mm²; 2202 Series



Technical Data	
0.25 ... 2.5 (4) mm ² ①	22 ... 12 AWG
400 V/6 kV/3 ②	
I _N 16 A	
Terminal block width: 5.2 mm / 0.205 inch	
 10 ... 12 mm / 0.39 ... 0.47 inch	

Technical Data	
0.25 ... 2.5 (4) mm ² ①	22 ... 12 AWG
400 V/6 kV/3 ②	
I _N 16 A	
Terminal block width: 5.2 mm / 0.205 inch	
 10 ... 12 mm / 0.39 ... 0.47 inch	

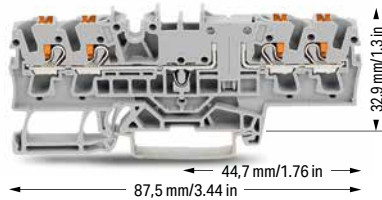
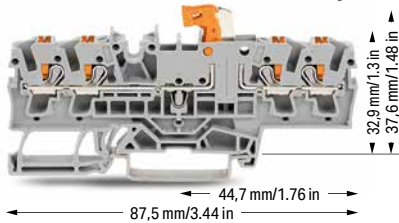

Available June 2019



4-conductor disconnect/test terminal block; with push-button; with test point; Orange disconnect link



Color	Item No.	Pack. Unit
 gray	2202-1871	50
 blue	2202-1874	50
 orange	2202-1872	50

4-conductor through terminal block; with push-button; with test point; Same profile as 4-conductor disconnect terminal block

Color	Item No.	Pack. Unit
 gray	2202-1801	50
 blue	2202-1804	50
 orange	2202-1802	50

Other terminal blocks with the same profile		
Fuse	2202-1881	Page 14
Carrier	2202-1861	









Accessories; 2202 Series
Appropriate marking systems: WMB/WMB Inline/Marking strips



End and intermediate plate; 1 mm thick		
 orange	2002-1892	100 (25)
 gray	2002-1891	100 (25)









Insulation stop; 5 pcs/strip; 0.25 ... 0.5 mm ²		
 light gray	2002-171	200 (25)

Insulation stop; 5 pcs/strip; 0.75 ... 1 mm ²		
 dark gray	2002-172	200 (25)

Protective warning marker; with black high-voltage symbol; for 5 terminal blocks		
 yellow	2002-115	100 (25)











Push-in type jumper bar; insulated; I _N 25 A; light gray		
 2-way	2002-402	25
 3-way	2002-403	25
 4-way	2002-404	25
 5-way	2002-405	25
 6-way	2002-406	25
 7-way	2002-407	25
 8-way	2002-408	25
 9-way	2002-409	25
 10-way	2002-410	25

Push-in type wire jumper; insulated; 1.5 mm ² conductor cross section; I _N 18 A		
 L = 60 mm	2009-412	100 (10)
 L = 110 mm	2009-414	100 (10)
 L = 250 mm	2009-416	100 (10)

Push-in type jumper bar; insulated; I _N 25 A; light gray		
 1 to 3	2002-433	25
 1 to 4	2002-434	25
 1 to 5	2002-435	25
 1 to 6	2002-436	25
 1 to 7	2002-437	25
 1 to 8	2002-438	25
 1 to 9	2002-439	25
 1 to 10	2002-440	25

Delta jumper; insulated; I _N = I _N terminal block; light gray		
 1-2 3-4 5-6	2002-406/020-000	25

Star point jumper; insulated; I _N = I _N terminal block; light gray		
 1-3-5	2002-405/011-000	25

Staggered jumper; insulated; I _N 25 A; light gray		
 2-way	2002-472	25
 3-way	2002-473	25
 4-way	2002-474	25
 5-way	2002-475	25
 6-way	2002-476	25
 7-way	2002-477	25
 8-way	2002-478	25
 9-way	2002-479	25
 10-way	2002-480	25
 11-way	2002-481	25
 12-way	2002-482	25

① Conductor range: 0.25 ... 2.5 mm² "s+f-st" and 0.25 ... 4 mm² "s"; Push-in termination: 1 ... 4 mm² "s" and 1 ... 2.5 mm² "insulated ferrules, 12 mm" Depending on the conductor characteristic, a conductor with a smaller cross section can also be inserted via push-in termination.

② 400 V = rated voltage
6 kV = rated impulse voltage
3 = pollution degree
(see Full Line Catalog, Volume 1, Section 14)

See application notes in our Full Line Catalog, Volume 1. Jumpers, from page 152
Testing accessories, from page 146
Marking accessories, from page 588

Approvals and corresponding ratings, visit www.wago.com

Accessories; 2202 Series

Appropriate marking systems: WMB/WMB Inline/Marking strips

Customized staggered jumper; insulated; with contact lugs broken off at the factory and circuit printing; I_N 25 A; light gray

 1-3	2002-473/011-000	25
 1-3-5	2002-475/011-000	25
 1-3-5-7	2002-477/011-000	25
 1-3-5-7-9	2002-479/011-000	25
 1-3-5-7-9-11	2002-481/011-000	25

Adjacent jumper for continuous commoning; insulated; I_N 25 A; light gray

 2-way	2002-400	25
---	----------	----

Adjacent jumper for continuous commoning; insulated; I_N 25 A; 1 to 3

 light gray	2002-423	25
 red	2002-423/000-005	25
 blue	2002-423/000-006	25

Modular connector; snaps together; for jumper contact slot

 gray	2002-511	100 (25)
--	----------	----------

Spacer module; snaps together; bridges commoned terminal blocks

 gray	2002-549	100 (25)
--	----------	----------

End plate; for modular connector; 1.5 mm thick

 gray	2002-541	100 (25)
--	----------	----------

Accessories; 2202 Series

Appropriate marking systems:
WMB/WMB Inline/Marking strips

L-type test plug module; snaps together

gray 2002-611 100 (25)

L-type spacer module; snaps together; bridges commoned terminal blocks,

gray 2002-649 100 (25)

End plate; for modular test plug module; 1.5 mm thick

gray 2002-641 100 (25)

Test plug adapter; for 4 mm Ø test plug

gray 2009-174 100 (25)

Banana plug; for 4 mm socket diameter; color mixed; 10 x orange, white, black, blue, yellow; max. 42 V

215-111 50

Testing tap; for max. 2.5 mm²

gray 2009-182 100 (25)

WMB Inline; plain; 1,500 WMB markers (5 mm)/reel; stretchable 5 ... 5.2 mm

white 2009-115 1

Marking strip; plain; 11 mm wide; 50 m reel

white 2009-110 1

WMB marker card; white; 10 strips with 10 markers/card; stretchable 5 ... 5.2 mm

plain 793-5501 5

Double-deck marker carrier; pivoting

gray 2002-121 50 (25)

Fuse Terminal Block TOPJOB® S; with Push-Button; for Mini-Automotive Blade-Style Fuse 2.5 (4) mm²; 2202 Series

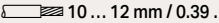
Technical Data	
0.25 ... 2.5 (4) mm ² ❶	22 ... 12 AWG
400 V/6 kV/3 ❷	300 V, 10 A ❸
I _N 10 A ❸	300 V, 10 A ❸
Terminal block width: 5.2 mm / 0.205 inch	
 10 ... 12 mm / 0.39 ... 0.47 inch	

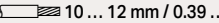
Technical Data	
0.25 ... 2.5 (4) mm ² ❶	22 ... 12 AWG
400 V/6 kV/3 ❷	300 V, 10 A ❸
I _N 10 A ❸	300 V, 10 A ❸
Terminal block width: 5.2 mm / 0.205 inch	
 10 ... 12 mm / 0.39 ... 0.47 inch	

Technical Data	
0.25 ... 2.5 (4) mm ² ❶	22 ... 12 AWG
400 V/6 kV/3 ❷	300 V, 10 A ❸
I _N 10 A ❸	300 V, 10 A ❸
Terminal block width: 5.2 mm / 0.205 inch	
 10 ... 12 mm / 0.39 ... 0.47 inch	

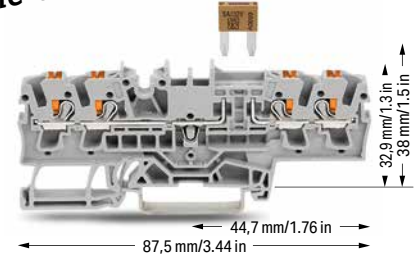
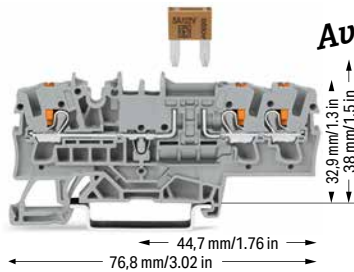
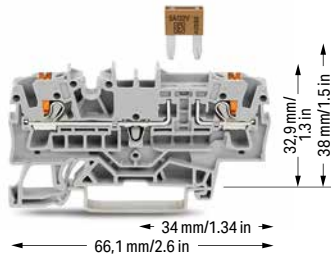

Available June 2019

2-conductor fuse terminal block; with push-button; for mini-automotive blade-style fuse; with test point		
Color	Item No.	Pack. Unit
○ gray	2202-1681	50

3-conductor fuse terminal block; with push-button; for mini-automotive blade-style fuse; with test point		
Color	Item No.	Pack. Unit
○ gray	2202-1781	50

4-conductor fuse terminal block; with push-button; for mini-automotive blade-style fuse; with test point		
Color	Item No.	Pack. Unit
○ gray	2202-1881	100

Blade-style fuses are not offered by WAGO.



Blade-style fuses are not offered by WAGO.



Blade-style fuses are not offered by WAGO.



Other terminal blocks with the same profile		
Through	Item No.	Page
Through	2202-1601	Page 8

Other terminal blocks with the same profile		
Through	Item No.	Page
Through	2202-1701	Page 10

Other terminal blocks with the same profile		
Through	Item No.	Page
Through	2202-1801	Page 12

Item-Specific Accessories			
End and intermediate plate; 1 mm thick			
	orange	2002-1692	100 (25)
	gray	2002-1691	100 (25)

Item-Specific Accessories			
End and intermediate plate; 1 mm thick			
	orange	2002-1792	100 (25)
	gray	2002-1791	100 (25)

Item-Specific Accessories			
End and intermediate plate; 1 mm thick			
	orange	2002-1892	100 (25)
	gray	2002-1891	100 (25)









Accessories; 2202 Series



Appropriate marking systems: WMB/WMB Inline/Marking strips









Insulation stop; 5 pcs/strip; 0.25 ... 0.5 mm ²			
	light gray	2002-171	200 (25)

Insulation stop; 5 pcs/strip; 0.75 ... 1 mm ²			
	dark gray	2002-172	200 (25)

Protective warning marker; with black high-voltage symbol; for 5 terminal blocks			
	yellow	2002-115	100 (25)











Push-in type jumper bar; insulated; I _N 25 A; light gray			
	2-way	2002-402	25
	3-way	2002-403	25
	4-way	2002-404	25
	5-way	2002-405	25
	6-way	2002-406	25
	7-way	2002-407	25
	8-way	2002-408	25
	9-way	2002-409	25
	10-way	2002-410	25





Push-in type wire jumper; insulated; 1.5 mm ² conductor cross section; I _N 18 A			
	L = 60 mm	2009-412	100 (10)
	L = 110 mm	2009-414	100 (10)
	L = 250 mm	2009-416	100 (10)

Push-in type jumper bar; insulated; I _N 25 A; light gray			
	1 to 3	2002-433	25
	1 to 4	2002-434	25
	1 to 5	2002-435	25
	1 to 6	2002-436	25
	1 to 7	2002-437	25
	1 to 8	2002-438	25
	1 to 9	2002-439	25
	1 to 10	2002-440	25



Delta jumper; insulated; I _N = I _N terminal block; light gray			
	1-2 3-4 5-6	2002-406/020-000	25

Star point jumper; insulated; I _N = I _N terminal block; light gray			
	1-3-5	2002-405/011-000	25

Staggered jumper; insulated; I _N 25 A; light gray			
	2-way	2002-472	25
	3-way	2002-473	25
	4-way	2002-474	25
	5-way	2002-475	25
	6-way	2002-476	25
	7-way	2002-477	25
	8-way	2002-478	25
	9-way	2002-479	25
	10-way	2002-480	25
	11-way	2002-481	25
	12-way	2002-482	25

Customized staggered jumper; insulated; with contact lugs broken off at the factory and circuit printing; I _N 25 A; light gray			
	1-3	2002-473/011-000	25
	1-3-5	2002-475/011-000	25
	1-3-5-7	2002-477/011-000	25
	1-3-5-7-9	2002-479/011-000	25
	1-3-5-7-9-11	2002-481/011-000	25

Adjacent jumper for continuous commoning; insulated; I _N 25 A; light gray			
	2-way	2002-400	25

Adjacent jumper for continuous commoning; insulated; I _N 25 A; 1 to 3			
	light gray	2002-423	25
	red	2002-423/000-005	25
	blue	2002-423/000-006	25

Modular connector; snaps together; for jumper contact slot			
	gray	2002-511	100 (25)

Spacer module; snaps together; bridges commoned terminal blocks			
	gray	2002-549	100 (25)

① Conductor range: 0.25 ... 2.5 mm² "s+f-st" and 0.25 ... 4 mm² "s";
Push-in termination: 1 ... 4 mm² "s" and 1 ... 2.5 mm² "insulated ferrules, 12 mm"
Depending on the conductor characteristic, a conductor with a smaller cross section can also be inserted via push-in termination.

② 400 V = rated voltage
6 kV = rated impulse voltage
3 = pollution degree
(see Full Line Catalog, Volume 1, Section 14)

③ Observe touch-proof protection for 42 V and higher voltages!
• 10 A (individual arrangement)
• 5 A (block arrangement)

See application notes in our Full Line Catalog, Volume 1.
Jumpers, from page 152
Testing accessories, from page 146
Marking accessories, from page 588

Approvals and corresponding ratings,
visit www.wago.com

Accessories; 2202 Series

Appropriate marking systems:
WMB/WMB Inline/Marking strips

L-type test plug module; snaps together



gray 2002-611 100 (25)

L-type spacer module; snaps together; bridges commoned terminal blocks,



gray 2002-649 100 (25)

Test plug adapter; for 4 mm Ø test plug



gray 2009-174 100 (25)

Banana plug; for 4 mm socket diameter; color mixed; 10 x orange, white, black, blue, yellow; max. 42 V



215-111 50

Testing tap; for max. 2.5 mm²



gray 2009-182 100 (25)

WMB Inline; plain; 1,500 WMB markers (5 mm)/reel; stretchable 5 ... 5.2 mm



white 2009-115 1

Marking strip; plain; 11 mm wide; 50 m reel



white 2009-110 1

WMB marker card; white; 10 strips with 10 markers/card; stretchable 5 ... 5.2 mm



plain 793-5501 5

Double-deck marker carrier; pivoting



gray 2002-121 50 (25)

Fused Disconnect Terminal Block with a Pivoting Fuse Holder TOPJOB® S; with Push-Button; for (5 x 20) mm Glass Cartridge Fuse 2.5 (4) mm²; 2202 Series

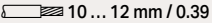
Technical Data	
0.25 ... 2.5 (4) mm ² ①	22 ... 12 AWG
250 V/6 kV/3 ②	250 V, 6.3 A ^{VA}
I _N 6.3 A	250 V, 6.3 A [Ⓞ]
Terminal block width: 6.2 mm / 0.244 inch	
 10 ... 12 mm / 0.39 ... 0.47 inch	

Technical Data	
0.25 ... 2.5 (4) mm ² ①	22 ... 12 AWG
250 V/6 kV/3 ②	250 V, 6.3 A ^{VA}
I _N 6.3 A	250 V, 6.3 A [Ⓞ]
Terminal block width: 6.2 mm / 0.244 inch	
 10 ... 12 mm / 0.39 ... 0.47 inch	

Technical Data	
0.25 ... 2.5 (4) mm ² ①	22 ... 12 AWG
250 V/6 kV/3 ②	250 V, 6.3 A ^{VA}
I _N 6.3 A	250 V, 6.3 A [Ⓞ]
Terminal block width: 6.2 mm / 0.244 inch	
 10 ... 12 mm / 0.39 ... 0.47 inch	

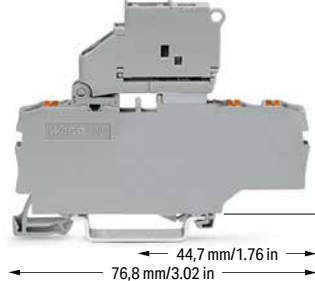
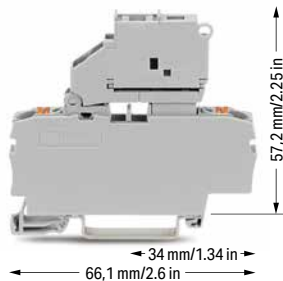

Available June 2019

2-conductor fused disconnect terminal block with a pivoting fuse holder; with push-button; for (5 x 20) mm glass cartridge fuse; without blown fuse indication
Electrical ratings are given by the fuse.

	Item No.	Pack. Unit
○ gray	2202-1611	50

3-conductor fused disconnect terminal block with a pivoting fuse holder; with push-button; for (5 x 20) mm glass cartridge fuse; without blown fuse indication
Electrical ratings are given by the fuse.

	Item No.	Pack. Unit
○ gray	2202-1711	50

4-conductor fused disconnect terminal block with a pivoting fuse holder; with push-button; for (5 x 20) mm glass cartridge fuse; without blown fuse indication
Electrical ratings are given by the fuse.

	Item No.	Pack. Unit
○ gray	2202-1811	100

2-conductor fused disconnect terminal block with a pivoting fuse holder; with push-button; for (5 x 20) mm glass cartridge fuse; with blown fuse indication by LED; gray
Electrical ratings are given by the fuse and blown fuse indication. Leakage current in case of a blown fuse: LED 2 mA

○ 12 ... 30 V	2202-1611/1000-541	50
○ 30 ... 65 V	2202-1611/1000-542	50
○ 230 V	2202-1611/1000-836	50
○ 120 V	2202-1611/1000-867	50

3-conductor fused disconnect terminal block with a pivoting fuse holder; with push-button; for (5 x 20) mm glass cartridge fuse; with blown fuse indication by LED; gray
Electrical ratings are given by the fuse and blown fuse indication. Leakage current in case of a blown fuse: LED 2 mA

○ 12 ... 30 V	2202-1711/1000-541	50
○ 30 ... 65 V	2202-1711/1000-542	50
○ 230 V	2202-1711/1000-836	50
○ 120 V	2202-1711/1000-867	50

4-conductor fused disconnect terminal block with a pivoting fuse holder; with push-button; for (5 x 20) mm glass cartridge fuse; with blown fuse indication by LED; gray
Electrical ratings are given by the fuse and blown fuse indication. Leakage current in case of a blown fuse: LED 2 mA

○ 12 ... 30 V	2202-1811/1000-541	50
○ 30 ... 65 V	2202-1811/1000-542	50
○ 230 V	2202-1811/1000-836	50
○ 120 V	2202-1811/1000-867	50

Other terminal blocks with the same profile		
Through	2202-1601	Page 8

Other terminal blocks with the same profile		
Through	2202-1701	Page 10

Other terminal blocks with the same profile		
Through	2202-1801	Page 12

Accessories; 2202 Series

Appropriate marking systems: WMB/WMB Inline/Marking strips

End plate for fuse terminal blocks; 2 mm thick			
	orange	2002-992	100 (25)
	gray	2002-991	100 (25)

Push-in type jumper bar; insulated; I _N 32 A; light gray			
	2-way	2004-402	25
	3-way	2004-403	25
	4-way	2004-404	25
	5-way	2004-405	25
	6-way	2004-406	25
	7-way	2004-407	25
	8-way	2004-408	25
	9-way	2004-409	25
	10-way	2004-410	25

Push-in type jumper bar; insulated; I _N 32 A; light gray			
	1 to 3	2004-433	25
	1 to 4	2004-434	25
	1 to 5	2004-435	25
	1 to 6	2004-436	25
	1 to 7	2004-437	25
	1 to 8	2004-438	25
	1 to 9	2004-439	25
	1 to 10	2004-440	25

Insulation stop; 5 pcs/strip; 0.25 ... 0.5 mm ²		
	light gray	2002-171

Insulation stop; 5 pcs/strip; 0.75 ... 1 mm ²		
	dark gray	2002-172

Protective warning marker; with black high-voltage symbol; for 5 terminal blocks		
	yellow	2002-115

Push-in type wire jumper; insulated; 1.5 mm ² conductor cross section; I _N 18 A			
	L = 60 mm	2009-412	100 (10)
	L = 110 mm	2009-414	100 (10)
	L = 250 mm	2009-416	100 (10)

① Conductor range: 0.25 ... 2.5 mm² "s+f-st" and 0.25 ... 4 mm² "s";
Push-in termination: 1 ... 4 mm² "s" and 1 ... 2.5 mm² "insulated ferrules, 12 mm"
Depending on the conductor characteristic, a conductor with a smaller cross section can also be inserted via push-in termination.

② 250 V = rated voltage
6 kV = rated impulse voltage
3 = pollution degree
(see Full Line Catalog, Volume 1, Section 14)

See application notes in our Full Line Catalog, Volume 1. Jumpers, from page 156
Marking accessories, from page 588

A protective warning marker and an insulation stop must be applied individually. Due to the 6.2 mm width of double-deck terminal blocks with end plates, 2004 Series Push-In Type Jumper Bars must be used.

Approvals and corresponding ratings, visit www.wago.com

Miniature fuses 5 x 20

Series Item No.	Overload and short circuit protection		Short circuit protection only	
	Individual argmt.	Group argmt.	Individual argmt.	Group argmt.
Fuse terminal blocks				
2202-1611				
2202-1711	1.6 W	1.6 W	2.5 W	2.5 W
2202-1811				
2202-1611/...-?...-...				
2202-1711/...-?...-...	1.6 W	1.6 W	2.5 W	2.5 W
2202-1811/...-?...-...				

When selecting glass cartridge fuses, make sure that the maximum power loss listed below is not exceeded. The power loss is determined according to IEC or EN 60947-7-3/VDE 0611-6 at 23°C. The temperature rise of the terminal block must be checked according to their application and mounting. Higher ambient temperatures represent an additional impact on miniature fuses. Therefore, in such applications, the rated current must be reduced if necessary. More details are available from the manufacturers.

Disconnect/Test Terminal Block; Through Terminal Block and Ground Conductor Terminal Block TOPJOB® S; with Push-Button; with Additional Jumper Slot

2.5 (4) mm²; 2202 Series



Technical Data	
0.25 ... 2.5 (4) mm ² ①	22 ... 12 AWG
400 V/6 kV/3 ②	
I _N 16 A	
Terminal block width: 5.2 mm / 0.205 inch	
 10 ... 12 mm / 0.39 ... 0.47 inch	

Technical Data	
0.25 ... 2.5 (4) mm ² ①	22 ... 12 AWG
400 V/6 kV/3 ②	
I _N 16 A	
Terminal block width: 5.2 mm / 0.205 inch	
 10 ... 12 mm / 0.39 ... 0.47 inch	

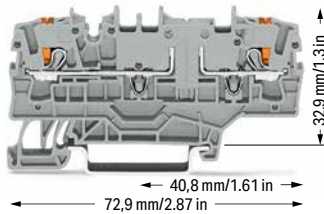
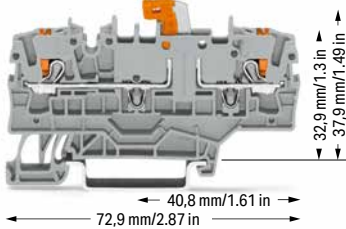

Available June 2019



2-conductor disconnect/test terminal block; with push-button; with test point; Orange disconnect link; with additional jumper slot

Color	Item No.	Pack. Unit
 gray	2202-1971	50
 blue	2202-1974	50
 orange	2202-1972	50

2-conductor through terminal block; with push-button; with test point; with additional jumper slot; same profile as 2-conductor disconnect terminal block

Color	Item No.	Pack. Unit
 gray	2202-1901	50
 blue	2202-1904	50
 orange	2202-1902	50

2-conductor ground terminal block; with push-button

 green-yellow	2202-1907	50
---	-----------	----

Other terminal blocks with the same profile

Fuse	2202-1981	Page 20
Carrier	2202-1961	

① Conductor range: 0.25 ... 2.5 mm² "s+f-st" and 0.25 ... 4 mm² "s"; Push-in termination: 1 ... 4 mm² "s" and 1 ... 2.5 mm² "insulated ferrules, 12 mm" Depending on the conductor characteristic, a conductor with a smaller cross section can also be inserted via push-in termination.

② 400 V = rated voltage
6 kV = rated impulse voltage
3 = pollution degree
(see Full Line Catalog, Volume 1, Section 14)

See application notes in our Full Line Catalog, Volume 1. Jumpers, from page 152
Testing accessories, from page 146
Marking accessories, from page 588

Approvals and corresponding ratings, visit www.wago.com

Accessories; 2202 Series

Appropriate marking systems:
WMB/WMB Inline/Marking strips

Customized staggered jumper; insulated; with contact lugs broken off at the factory and circuit printing; I_N 25 A; light gray

	1-3	2002-473/011-000	25
	1-3-5	2002-475/011-000	25
	1-3-5-7	2002-477/011-000	25
	1-3-5-7-9	2002-479/011-000	25
	1-3-5-7-9-11	2002-481/011-000	25

Adjacent jumper for continuous commoning; insulated; I_N 25 A; light gray

	2-way	2002-400	25
---	-------	----------	----

Adjacent jumper for continuous commoning; insulated; I_N 25 A; 1 to 3

	light gray	2002-423	25
	red	2002-423/000-005	25
	blue	2002-423/000-006	25

Modular connector; snaps together; for jumper contact slot

	gray	2002-511	100 (25)
---	------	----------	----------

End plate; for modular connector; 1.5 mm thick

	gray	2002-541	100 (25)
---	------	----------	----------

Accessories; 2202 Series

End and intermediate plate; 1 mm thick
Appropriate marking systems: WMB/WMB Inline/Marking strips
Push-in type jumper bar; insulated; I_N 25 A; light gray

	orange	2002-1992	100 (25)
	gray	2002-1991	100 (25)

Insulation stop; 5 pcs/strip; 0.25 ... 0.5 mm²

	light gray	2002-171	200 (25)
---	------------	----------	----------

Insulation stop; 5 pcs/strip; 0.75 ... 1 mm²

	dark gray	2002-172	200 (25)
---	-----------	----------	----------

Protective warning marker; with black high-voltage symbol; for 5 terminal blocks

	yellow	2002-115	100 (25)
---	--------	----------	----------

Push-in type jumper bar; insulated; I_N 25 A; light gray

	2-way	2002-402	25
	3-way	2002-403	25
	4-way	2002-404	25
	5-way	2002-405	25
	6-way	2002-406	25
	7-way	2002-407	25
	8-way	2002-408	25
	9-way	2002-409	25
	10-way	2002-410	25

Push-in type wire jumper; insulated; 1.5 mm² conductor cross section; I_N 18 A

	L = 60 mm	2009-412	100 (10)
	L = 110 mm	2009-414	100 (10)
	L = 250 mm	2009-416	100 (10)

Delta jumper; insulated; I_N = I_N terminal block; light gray

	1-2 3-4 5-6	2002-406/020-000	25
---	-------------	------------------	----

Star point jumper; insulated; I_N = I_N terminal block; light gray

	1-3-5	2002-405/011-000	25
---	-------	------------------	----

Staggered jumper; insulated; I_N 25 A; light gray

	2-way	2002-472	25
	3-way	2002-473	25
	4-way	2002-474	25
	5-way	2002-475	25
	6-way	2002-476	25
	7-way	2002-477	25
	8-way	2002-478	25
	9-way	2002-479	25
	10-way	2002-480	25
	11-way	2002-481	25
	12-way	2002-482	25

Accessories; 2202 Series

Appropriate marking systems:
WMB/WMB Inline/Marking strips

L-type test plug module; snaps together

	gray	2002-611	100 (25)
---	------	----------	----------

L-type spacer module; snaps together; bridges commoned terminal blocks,

	gray	2002-649	100 (25)
---	------	----------	----------

End plate; for modular test plug module; 1.5 mm thick

	gray	2002-641	100 (25)
---	------	----------	----------

Test plug adapter; for 4 mm Ø test plug

	gray	2009-174	100 (25)
---	------	----------	----------

Banana plug; for 4 mm socket diameter; color mixed; 10 x orange, white, black, blue, yellow; max. 42 V

		215-111	50
---	--	---------	----

Testing tap; for max. 2.5 mm²

	gray	2009-182	100 (25)
--	------	----------	----------

WMB Inline; plain; 1,500 WMB markers (5 mm)/reel; stretchable 5 ... 5.2 mm

	white	2009-115	1
---	-------	----------	---

Marking strip; plain; 11 mm wide; 50 m reel

	white	2009-110	1
---	-------	----------	---

WMB marker card; white; 10 strips with 10 markers/card; stretchable 5 ... 5.2 mm

	plain	793-5501	5
---	-------	----------	---

Double-deck marker carrier; pivoting

	gray	2002-121	50 (25)
---	------	----------	---------

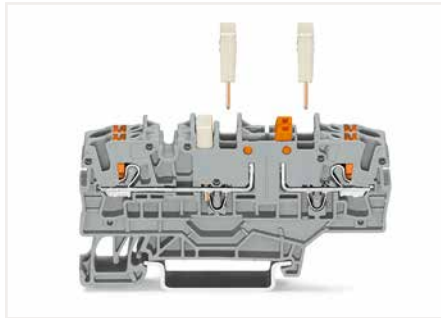

Three jumper slots available

Fuse Terminal Block TOPJOB® S; with Push-Button; for Mini-Automotive Blade-Style Fuse 2.5 (4) mm²; 2202 Series

Technical Data	
0.25 ... 2.5 (4) mm ² ❶	22 ... 12 AWG
400 V/6 kV/3 ❷	12 V, 10 A ❸
I _N 10 A ❸	
Terminal block width: 5.2 mm / 0.205 inch	
10 ... 12 mm / 0.39 ... 0.47 inch	

Technical Data	
0.25 ... 2.5 (4) mm ² ❶	22 ... 12 AWG
400 V/6 kV/3 ❷	24 V, 10 A ❸
I _N 10 A ❸	
Terminal block width: 5.2 mm / 0.205 inch	
10 ... 12 mm / 0.39 ... 0.47 inch	

Technical Data	
0.25 ... 2.5 (4) mm ² ❶	22 ... 12 AWG
400 V/6 kV/3 ❷	48 V, 10 A ❸
I _N 10 A ❸	
Terminal block width: 5.2 mm / 0.205 inch	
10 ... 12 mm / 0.39 ... 0.47 inch	

Available June 2019

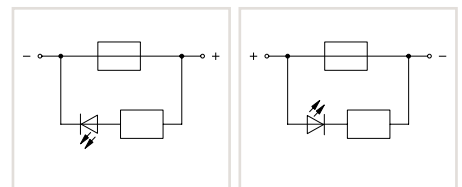
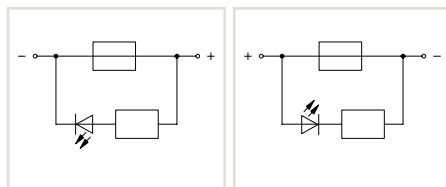
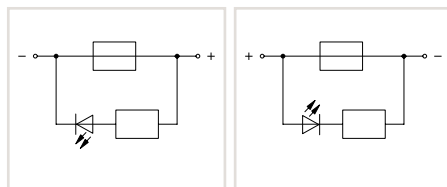
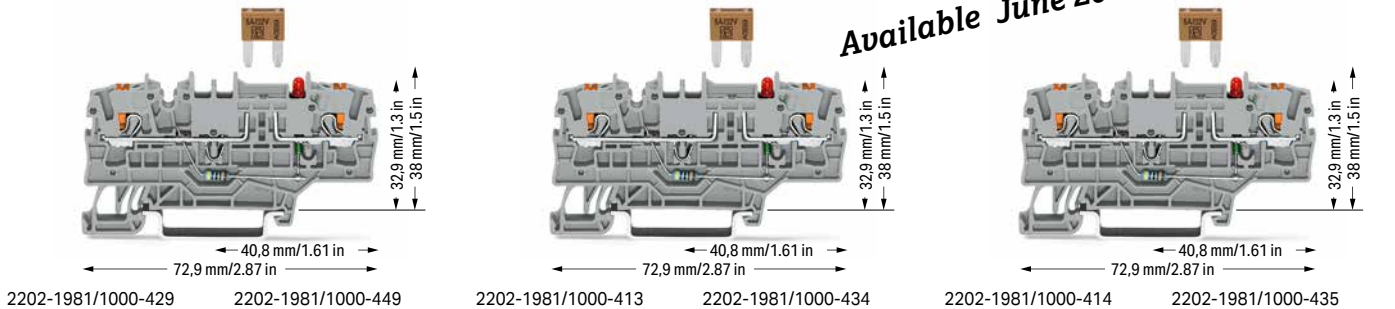

2-conductor fuse terminal block; with push-button; for mini-automotive blade-style fuse; with test point; 12 V; with blown fuse indication by LED; LED power consumption: 4.8 mA
Electrical ratings are given by the fuse and blown fuse indication. Blade-style fuses: Observe touch-proof protection for 42 V and higher voltages!

2-conductor fuse terminal block; with push-button; for mini-automotive blade-style fuse; with test point; 24 V; with blown fuse indication by LED; LED power consumption: 4.8 mA
Electrical ratings are given by the fuse and blown fuse indication. Blade-style fuses: Observe touch-proof protection for 42 V and higher voltages!

2-conductor fuse terminal block; with push-button; for mini-automotive blade-style fuse; with test point; 48 V; with blown fuse indication by LED; LED power consumption: 4.8 mA
Electrical ratings are given by the fuse and blown fuse indication. Blade-style fuses: Observe touch-proof protection for 42 V and higher voltages!

Color	Item No.	Pack. Unit
○ gray	2202-1981/1000-429	50
○ gray	2202-1981/1000-449	50

Color	Item No.	Pack. Unit
○ gray	2202-1981/1000-413	50
○ gray	2202-1981/1000-434	50

Color	Item No.	Pack. Unit
○ gray	2202-1981/1000-414	50
○ gray	2202-1981/1000-435	50

Other terminal blocks with the same profile		
Through	2202-1901	Page 18

Accessories; 2202 Series

Appropriate marking systems: WMB/WMB Inline/Marking strips

End and intermediate plate; 1 mm thick		
orange	2002-1992	100 (25)
gray	2002-1991	100 (25)

Insulation stop; 5 pcs/strip; 0.25 ... 0.5 mm ²		
light gray	2002-171	200 (25)

Insulation stop; 5 pcs/strip; 0.75 ... 1 mm ²		
dark gray	2002-172	200 (25)

Protective warning marker; with black high-voltage symbol; for 5 terminal blocks		
yellow	2002-115	100 (25)

Push-in type wire jumper; insulated; 1.5 mm ² conductor cross section; I _N 18 A		
L = 60 mm	2009-412	100 (10)
L = 110 mm	2009-414	100 (10)
L = 250 mm	2009-416	100 (10)

Push-in type jumper bar; insulated; I _N 25 A; light gray		
2-way	2002-402	25
3-way	2002-403	25
4-way	2002-404	25
5-way	2002-405	25
6-way	2002-406	25
7-way	2002-407	25
8-way	2002-408	25
9-way	2002-409	25
10-way	2002-410	25

Push-in type jumper bar; insulated; I _N 25 A; light gray		
1 to 3	2002-433	25
1 to 4	2002-434	25
1 to 5	2002-435	25
1 to 6	2002-436	25
1 to 7	2002-437	25
1 to 8	2002-438	25
1 to 9	2002-439	25
1 to 10	2002-440	25

Staggered jumper; insulated; I _N 25 A; light gray		
2-way	2002-472	25
3-way	2002-473	25
4-way	2002-474	25
5-way	2002-475	25
6-way	2002-476	25
7-way	2002-477	25
8-way	2002-478	25
9-way	2002-479	25
10-way	2002-480	25
11-way	2002-481	25
12-way	2002-482	25

Adjacent jumper for continuous commoning; insulated; I _N 25 A; light gray		
2-way	2002-400	25

Adjacent jumper for continuous commoning; insulated; I _N 25 A; 1 to 3		
light gray	2002-423	25
red	2002-423/000-005	25
blue	2002-423/000-006	25

Technical Data

0.25 ... 2.5 (4) mm² ① | 22 ... 12 AWG

400 V/6 kV/3 ② | 250 V, 10 A ③

I_N 10 A ③

Terminal block width: 5.2 mm / 0.205 inch

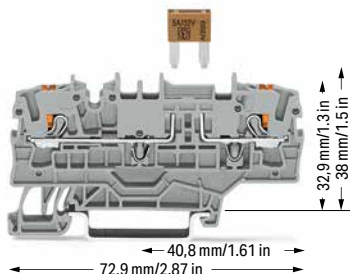
 10 ... 12 mm / 0.39 ... 0.47 inch

① Conductor range: 0.25 ... 2.5 mm² "s+f-st" and 0.25 ... 4 mm² "s";
Push-in termination: 1 ... 4 mm² "s" and 1 ... 2.5 mm² "insulated ferrules, 12 mm"
Depending on the conductor characteristic, a conductor with a smaller cross section can also be inserted via push-in termination.

② 400 V = rated voltage
6 kV = rated impulse voltage
3 = pollution degree
(see Full Line Catalog, Volume 1, Section 14)

③ Observe touch-proof protection for 42 V and higher voltages!
10 A (individual arrangement)
5 A (block arrangement)

Blade-style fuses are not offered by WAGO.

See application notes in our Full Line Catalog, Volume 1.
Jumpers, from page 152
Testing accessories, from page 146
Marking accessories, from page 588

Approvals and corresponding ratings,
visit www.wago.com

2-conductor fuse terminal block; with push-button; for mini-automotive blade-style fuse; with test point; without blown fuse indication; with additional jumper slot
Electrical ratings are given by the fuse. Blade-style fuses:
Observe touch-proof protection for 42 V and higher voltages!

Color	Item No.	Pack. Unit
○ gray	2202-1981	50

WMB Inline; plain; 1,500 WMB markers (5 mm)/reel;
stretchable 5 ... 5.2 mm

white	2009-115	1
-------	----------	---



Marking strip; plain; 11 mm wide; 50 m reel

white	2009-110	1
-------	----------	---



WMB marker card; white; 10 strips with 10 markers/card;
stretchable 5 ... 5.2 mm

plain	793-5501	5
-------	----------	---



Double-deck marker carrier; pivoting

gray	2002-121	50 (25)
------	----------	---------



PUSH-IN CAGE CLAMP®

Fused Disconnect Terminal Block with a Pivoting Fuse Holder TOPJOB® S; with Push-Button; with Additional Jumper Slot; for (5 x 20) mm Glass Cartridge Fuse 2.5 (4) mm²; 2202 Series

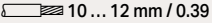
Technical Data	
0.25 ... 2.5 (4) mm ² ①	22 ... 12 AWG
250 V/6 kV/3 ②	600 V, 6,3 A ^{III}
I _N 6.3 A	
Terminal block width: 6.2 mm / 0.244 inch	
 10 ... 12 mm / 0.39 ... 0.47 inch	

Technical Data	
0.25 ... 2.5 (4) mm ² ①	22 ... 12 AWG
250 V/6 kV/3 ②	30 V, 6.3 A ^{III}
I _N 6.3 A	
Terminal block width: 6.2 mm / 0.244 inch	
 10 ... 12 mm / 0.39 ... 0.47 inch	

- ① Conductor range: 0.25 ... 2.5 mm² "s+f-st" and 0.25 ... 4 mm² "s"; Push-in termination: 1 ... 4 mm² "s" and 1 ... 2.5 mm² "insulated ferrules, 12 mm" Depending on the conductor characteristic, a conductor with a smaller cross section can also be inserted via push-in termination.
- ② 250 V = rated voltage
6 kV = rated impulse voltage
3 = pollution degree
(see Full Line Catalog, Volume 1, Section 14)

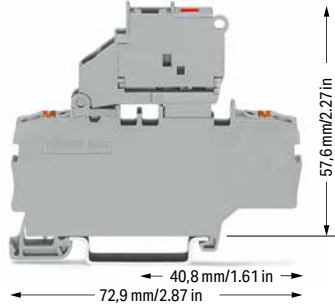
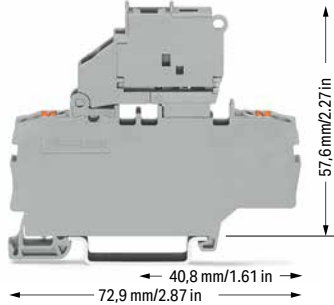

See application notes in our Full Line Catalog, Volume 1. Jumpers, from page 156
Marking accessories, from page 588





A protective warning marker and an insulation stop must be applied individually. Due to the 6.2 mm width of double-deck terminal blocks with end plates, 2004 Series Push-In Type Jumper Bars must be used.

Approvals and corresponding ratings, visit www.wago.com

2-conductor fused disconnect terminal block with a pivoting fuse holder; with push-button; with additional jumper slot; for (5 x 20) mm glass cartridge fuse; without blown fuse indication
Electrical ratings are given by the fuse.

2-conductor fused disconnect terminal block with a pivoting fuse holder; with push-button; with additional jumper slot; for (5 x 20) mm glass cartridge fuse; with blown fuse indication; gray
Electrical ratings are given by the fuse and blown fuse indication. Leakage current in case of a blown fuse: LED 2 mA

Color	Item No.	Pack. Unit
 gray	2202-1911	50

	Item No.	Pack. Unit
 12 ... 30 V	2202-1911/1000-541	50
 30 ... 65 V	2202-1911/1000-542	50
 120 V	2202-1911/1000-867	50
 230 V	2202-1911/1000-836	50

Available June 2019

Other terminal blocks with the same profile		
Through	2202-1901	Page 18

Other terminal blocks with the same profile		
Through	2202-1901	Page 18

Accessories; 2202 Series

Appropriate marking systems: WMB/WMB Inline/Marking strips

End plate for fuse terminal blocks; 2 mm thick

 orange	2002-992	100 (25)
 gray	2002-991	100 (25)

Insulation stop; 5 pcs/strip; 0.25 ... 0.5 mm²

 light gray	2002-171	200 (25)
--	----------	----------

Insulation stop; 5 pcs/strip; 0.75 ... 1 mm²

 dark gray	2002-172	200 (25)
---	----------	----------









Protective warning marker; with black high-voltage symbol; for 5 terminal blocks

 yellow	2002-115	100 (25)
--	----------	----------

Push-in type wire jumper; insulated; 1.5 mm² conductor cross section; I_N 18 A

 L = 60 mm	2009-412	100 (10)
 L = 110 mm	2009-414	100 (10)
 L = 250 mm	2009-416	100 (10)

Push-in type jumper bar; insulated; I_N 32 A; light gray

 2-way	2004-402	25
 3-way	2004-403	25
 4-way	2004-404	25
 5-way	2004-405	25
 6-way	2004-406	25
 7-way	2004-407	25
 8-way	2004-408	25
 9-way	2004-409	25
 10-way	2004-410	25

Push-in type jumper bar; insulated; I_N 32 A; light gray

 1 to 3	2004-433	25
 1 to 4	2004-434	25
 1 to 5	2004-435	25
 1 to 6	2004-436	25
 1 to 7	2004-437	25
 1 to 8	2004-438	25
 1 to 9	2004-439	25
 1 to 10	2004-440	25

Miniature fuses 5 x 20

Series Item No.	Overload and short circuit protection		Short circuit protection only	
	Individual argmt.	Group argmt.	Individual argmt.	Group argmt.
Fuse terminal blocks				
2202-1911	1.6 W	1.6 W	2.5 W	2.5 W
2202-1911/.....	1.6 W	1.6 W	2.5 W	2.5 W

When selecting glass cartridge fuses, make sure that the maximum power loss listed below is not exceeded. The power loss is determined according to IEC or EN 60947-7-3/VDE 0611-6 at 23°C. The temperature rise of the terminal block must be checked according to their application and mounting. Higher ambient temperatures represent an additional impact on miniature fuses. Therefore, in such applications, the rated current must be reduced if necessary. More details are available from the manufacturers.

2-Pin Carrier Terminal Block and 4-Pin Carrier Terminal Block X-COM®S-SYSTEM 2.5 (4) mm²; 2022 Series

Technical Data	
690 V/6 kV/3 ①	
I _N 24 A(32 A) ②	
Terminal block width: 5.2 mm / 0.205 in	

Available June 2019

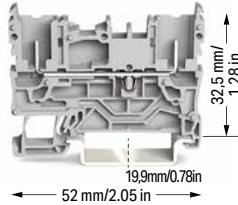

2-pin carrier terminal block		
Color	Item No.	Pack. Unit
gray	2022-1601	50
blue	2022-1604	50
orange	2022-1602	50

2-pin ground carrier terminal block		
Color	Item No.	Pack. Unit
green-yellow	2022-1607	50

Item-Specific Accessories			
End plate; 1 mm thick			
orange	2022-1692	100 (25)	
gray	2022-1691	100 (25)	

Accessories; 2022 Series
Appropriate marking systems: WMB/WMB Inline/Marking strips

Push-in type jumper bar; insulated; I _N 25 A; light gray			
2-way	2002-402	25	
3-way	2002-403	25	
4-way	2002-404	25	
5-way	2002-405	25	
6-way	2002-406	25	
7-way	2002-407	25	
8-way	2002-408	25	
9-way	2002-409	25	
10-way	2002-410	25	

Push-in type jumper bar; insulated; I _N 25 A; light gray			
1 to 3	2002-433	25	
1 to 4	2002-434	25	
1 to 5	2002-435	25	
1 to 6	2002-436	25	
1 to 7	2002-437	25	
1 to 8	2002-438	25	
1 to 9	2002-439	25	
1 to 10	2002-440	25	

Delta jumper; insulated; I _N = I _N terminal block; light gray			
1-2 3-4 5-6	2002-406/020-000	25	

Star point jumper; insulated; I _N = I _N terminal block; light gray			
1-3-5	2002-405/011-000	25	

Adjacent jumper for continuous commoning; insulated; I _N 25 A; light gray			
2-way	2002-400	25	

Technical Data	
690 V/6 kV/3 ①	
I _N 24 A (27 A) ②	
Terminal block width: 5.2 mm / 0.205 in	

Available September 2019

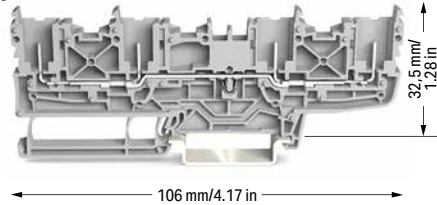

4-pin carrier terminal block		
Color	Item No.	Pack. Unit
gray	2022-1801	50
blue	2022-1804	50
orange	2022-1802	50

4-pin ground carrier terminal block		
Color	Item No.	Pack. Unit
green-yellow	2022-1807	50

Item-Specific Accessories			
End plate; 1 mm thick			
orange	2022-1892	100 (25)	
gray	2022-1891	100 (25)	

Accessories; 2022 Series
Appropriate marking systems: WMB/WMB Inline/Marking strips

Staggered jumper; insulated; I _N 25 A; light gray			
2-way	2002-472	25	
3-way	2002-473	25	
4-way	2002-474	25	
5-way	2002-475	25	
6-way	2002-476	25	
7-way	2002-477	25	
8-way	2002-478	25	
9-way	2002-479	25	
10-way	2002-480	25	
11-way	2002-481	25	
12-way	2002-482	25	

Adjacent jumper for continuous commoning; insulated; I _N 25 A; 1 to 3			
light gray	2002-423	25	
red	2002-423/000-005	25	
blue	2002-423/000-006	25	

Adjacent jumper for continuous commoning; insulated; I _N 25 A; light gray			
5-way	2002-415	25	

Push-in type wire jumper; insulated; 1.5 mm ² conductor cross section; I _N 18 A			
L = 60 mm	2009-412	100 (10)	
L = 110 mm	2009-414	100 (10)	
L = 250 mm	2009-416	100 (10)	

Carrier with 6 coding pins; for coding female plugs			
orange	2022-100	100 (25)	

1-conductor female plug			
gray	2022-101	200	

① 690 V = rated voltage
6 kV = rated impulse voltage
3 = pollution degree
(see Full Line Catalog, Volume 1, Section 14)

② Current-carrying capacity curves upon request

Note:
When used as intended, female plugs must not be connected/disconnected when live or under load.

See application notes in our Full Line Catalog, Volume 1. Jumpers, from page 152
Marking accessories, from page 588

Approvals and corresponding ratings, visit www.wago.com

Accessories; 2022 Series

Appropriate marking systems:
WMB/WMB Inline/Marking strips

1-conductor female plug			
gray	2022-101	200	

WMB Inline; plain; 1,500 WMB markers (5 mm)/reel; stretchable 5 ... 5.2 mm			
white	2009-115	1	

Marking strip; plain; 11 mm wide; 50 m reel			
white	2009-110	1	

WMB marker card; white; 10 strips with 10 markers/card; stretchable 5 ... 5.2 mm			
plain	793-5501	5	

WMB marker card; plain; 10 strips with 10 markers/card; stretchable 5 ... 5.2 mm			
yellow	793-5501/000-002	5	
red	793-5501/000-005	5	
blue	793-5501/000-006	5	
gray	793-5501/000-007	5	
orange	793-5501/000-012	5	
light green	793-5501/000-017	5	
green	793-5501/000-023	5	
violet	793-5501/000-024	5	

Screwless end stop; for DIN-35 rail; 6 mm wide			
gray	249-116	100 (25)	

Screwless end stop; for DIN-35 rail; 10 mm wide			
gray	249-117	50 (25)	

COMPACT Splicing Connectors for All Conductor Types and Mounting Carrier for Ex Splicing Connectors; fo Ex eb Applications; 221 Series

Description and Installation

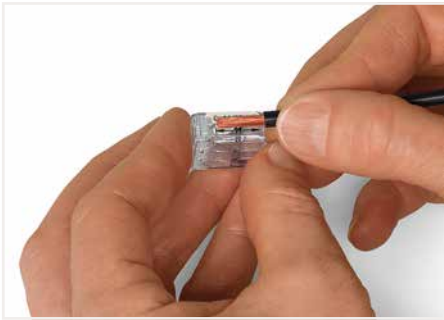

Strip conductor to 11 mm (0.43 inch).

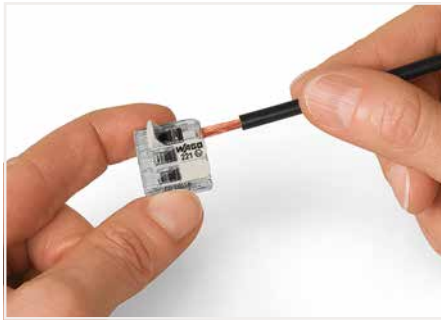

Termination: Lift the lever to open the clamping unit and insert a stripped conductor.

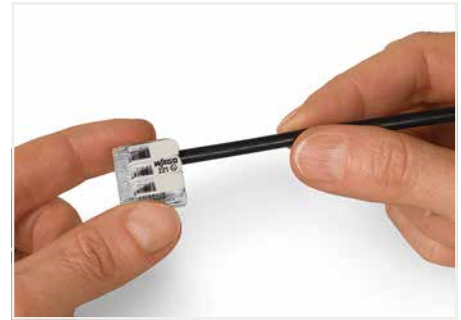

Then, lower the lever to close the clamp.

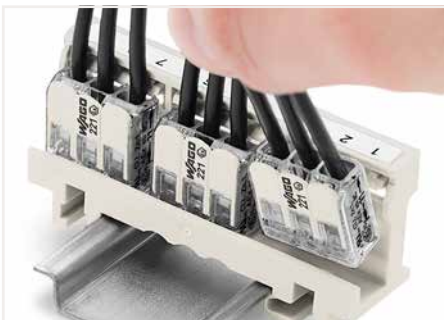

Inserting a connector into the mounting carrier.



Removing a connector from the mounting carrier.



Removing a conductor.



Mounting type (440 V)
Using spacers between the connectors.



Mounting type (440 V)
Vertical mounting on DIN-35 rail

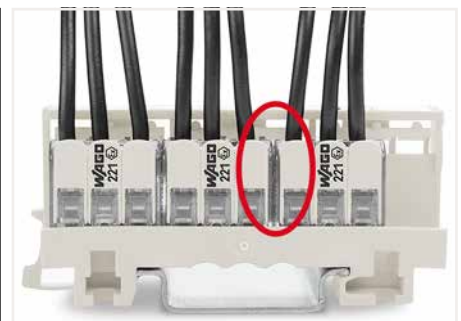

Mounting type (275 V)
No spacers are used between the connectors.



Mounting type (440 V)
Horizontal screw mounting on a flat surface



Mounting type (440 V)
Mounting the carrier via non-conductive screws.



Mounting type (275 V)
Mounting the carrier using conductive screws.

CAGE CLAMP® terminates the following copper conductors:
solid stranded

fine-stranded,
also with tinned
single strands

fine-stranded,
tip-bonded

COMPACT Splicing Connector for All Conductor Types and Mounting Carrier; fo Ex eb Applications

4 mm²; 221 Series

Technical Data	
IEC / EN 60079-7	UL 60079-7
Ⓔ IECEX Ex eb IIC Gb	Ⓔ Cl. I, Zn. 1, AEx eb IIC CNR Ex eb IIC U
0.2 ... 4 mm ² "s+str"	24 ... 12 AWG "s+st"
0.14 ... 4 mm ² "f-st"	24 ... 12 AWG "f-st"
440 V (275 V) ①	440 V (275 V), 20 A. Ⓔ ①
I _N 24.5 A	
Operating temperature: -55°C ... +105°C	
11 mm / 0.43 inch	



Dimensions in mm

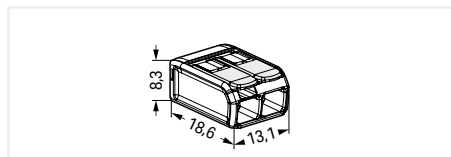

COMPACT splicing connector for all conductor types; for Ex eb applications; max. 4 mm²; 2-wire connector; with levers; Transparent housing; Light gray lever; Operating temperature (max.): 105 °C

Item No.	Pack. Unit
221-482 ②	1000 (100)

Technical Data	
IEC / EN 60079-7	UL 60079-7
Ⓔ IECEX Ex eb IIC Gb	Ⓔ Cl. I, Zn. 1, AEx eb IIC CNR Ex eb IIC U
0.2 ... 4 mm ² "s+str"	24 ... 12 AWG "s+st"
0.14 ... 4 mm ² "f-st"	24 ... 12 AWG "f-st"
440 V (275 V) ①	440 V (275 V), 20 A. Ⓔ ①
I _N 32 A	
Operating temperature: -55°C ... +105°C	
11 mm / 0.43 inch	



Dimensions in mm

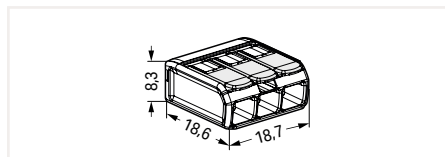

COMPACT splicing connector for all conductor types; for Ex eb applications; max. 4 mm²; 3-wire connector; with levers; Transparent housing; Light gray lever; Operating temperature (max.): 105 °C

Item No.	Pack. Unit
221-483 ②	500 (50)

① The permissible operating voltage of the connector with carrier (440 V or 275 V) depends on the mounting type.
The mounting types for both 440 V and 275 V are shown on the "Description and Installation" page. If a mounting type for 275 V is used, this is the permissible working voltage.

② Only approved in conjunction with a mounting carrier (221-501). Other carriers are possible, see certificate/file.
The connectors must be installed in an enclosure meeting the requirements of a recognized protection type per EN 60079-0, Section 1 or EN 60079-31. When installing the connectors in an enclosure of protection type "eb" (increased safety) per EN 60079-7, the clearances and creepage distances of Table 2 for this standard must be observed. For the use of accessories see point 1.
The connectors can be used both in Group II and Group I, as the standard requirements are identical in this case.
The use of these components requires a new assessment by a notified certification agency.

Approvals and corresponding ratings, visit www.wago.com

6 mm² variants upon request

Your benefits at a glance:

- New design possibilities for the manufacturers of junction boxes, luminaires and electronic devices for Ex eb areas
- Approval also possible with custom mounting solutions
- Easy to use: Pull the lever up, insert a conductor and push the lever back down – done.
- Easy-to-use design provides added value to the installer
- Time- and cost-saving spring pressure connection technology
- Vibration-proof and maintenance-free connection
- 100% touch-proof protection
- Connectors can be secured in position via mounting carriers according to standards



Mounting carrier; for 2-, 3- and 5-wire Ex splicing connectors (4 mm ²); 17.5 mm wide		
Color	Item No.	Pack. Unit
○ light gray	221-501	50 (10)

Item-Specific Accessories

Self-adhesive marking strip; 5 mm high; 48 self-adhesive strips per card; plain

white	210-334	100
-------	---------	-----



Dimensions in mm

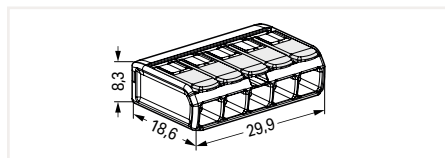

COMPACT splicing connector for all conductor types; for Ex eb applications; max. 4 mm²; 5-wire connector; with levers; Transparent housing; Light gray lever; Operating temperature (max.): 105 °C

Item No.	Pack. Unit
221-485 ②	250 (25)

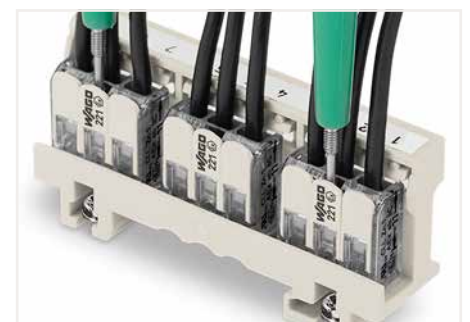

Easily test inserted connectors in the carrier – without considering the type of mounting.





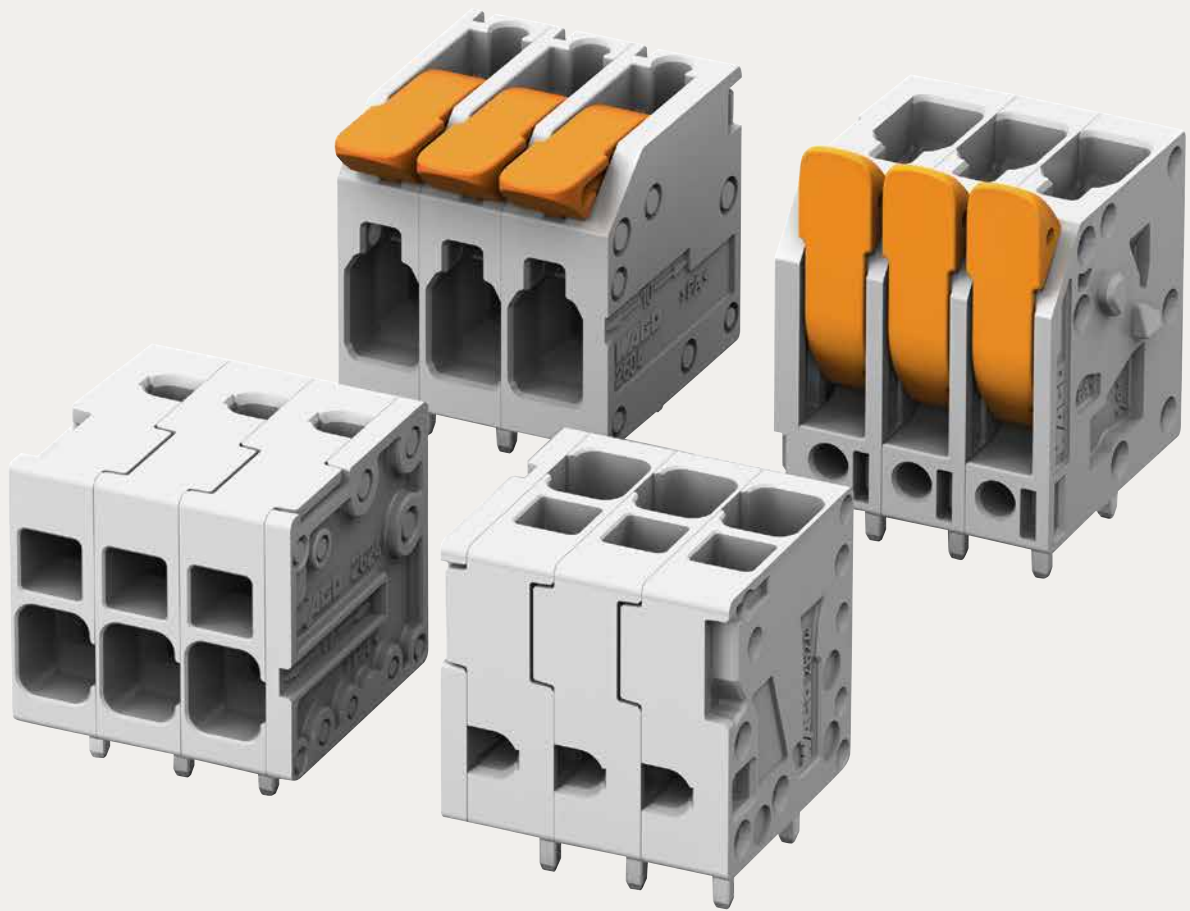



Wiring example in an Ex junction box



WAGO PCB Terminal Blocks and WAGO Connectors

Volume 2, WAGO PCB Terminal Blocks and WAGO Connectors

		Nominal Cross-Section	Series	Page
	PCB Terminal Blocks ▶ Actuation type: Lever ▶ Push-in CAGE CLAMP®	6 mm ²	2606	28
		16 mm ²	2616	30
	PCB Terminal Blocks ▶ Actuation type: Operating tool ▶ Push-in CAGE CLAMP®	6 mm ²	2626	32
		16 mm ²	2636	34
	1-Conductor Female Connectors ▶ MCS MAXI 6 ▶ Actuation type: Lever ▶ Push-in CAGE CLAMP®	6 mm ²	831	36
	1-Conductor Male Connectors ▶ MCS MAXI 6 ▶ Actuation type: Lever ▶ Push-in CAGE CLAMP®	6 mm ²	831	38
	THR Solder Pin Strips ▶ <i>picoMAX</i> ® 3.5		2091	40
	THR Solder Pin Strips ▶ <i>picoMAX</i> ® 5.0		2092	42
	THR Solder Pin Strips ▶ <i>picoMAX</i> ® 7.5		2092	44
	THR Solder Pin Strips ▶ <i>picoMAX</i> ® 3.5		2091	46
	THR Solder Pin Strips ▶ <i>picoMAX</i> ® 5.0		2092	48
	THR Solder Pin Strips ▶ <i>picoMAX</i> ® 7.5		2092	50

PCB Terminal Block ▶ 2606 Series

Push-in CAGE CLAMP® ▶ Actuation type: Lever ▶ 6 mm² ▶ Terminal strip ▶ Pin spacing: 12.5 mm (0.492 inch) ▶ Color: gray



- PCB terminal strips with lever-actuated Push-in CAGE CLAMP® connection
- Push-in termination of solid and ferruled conductors
- Intuitive and tool-free operation
- Several clamping units can be held open simultaneously – convenient for terminating multi-core cables
- Testing can be performed both parallel and perpendicular to conductor entry

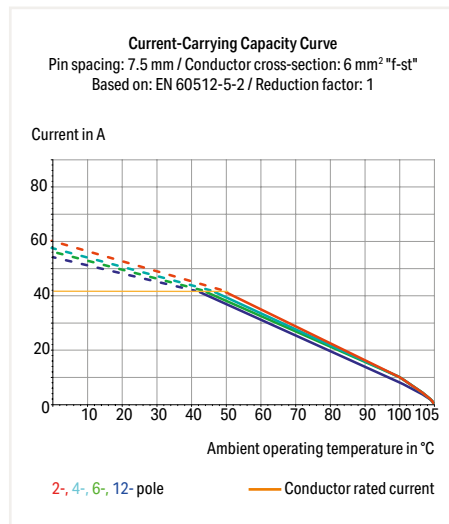

Electrical Data

Pin spacing	12.5 mm (0.492 inch)		
Ratings per	IEC/EN 60664-1		
Overvoltage category	III	III	II
Pollution degree	3	2	2
Rated voltage	800 V	1000 V	1000 V
Rated impulse voltage	8 kV	8 kV	8 kV
Rated current	41 A	41 A	41 A

Connection Data

Connection technology	Push-in CAGE CLAMP®
Strip length	11 ... 13 mm / 0.43 ... 0.51 inch
Solid conductor	0.2 ... 10 mm ² / 24 ... 8 AWG
Fine-stranded conductor	0.2 ... 10 mm ² / 24 ... 8 AWG
Fine-stranded conductor with ferrule with plastic collar	0.25 ... 6 mm ²
Fine-stranded conductor with ferrule without plastic collar	0.25 ... 6 mm ²
Fine-stranded conductor, with twin ferrule	0.25 ... 2.5 mm ²

Material Data

Material group	I
Insulating material	Polyamide 66 (PA 66)
Flammability class per UL94	V0
Clamping spring material	Chrome nickel spring steel (CrNi)
Contact material	Electrolytic copper (Ecu)
Contact plating	Tin-plated

Mechanical Data

Solder pin arrangement	Over the entire terminal strip, in line
Solder pin length	4 mm
Solder pin dimensions	1.5 x 1.2 mm
Drilled hole diameter (tolerance)	2 ^(+0.1) mm

Environmental Requirements

Limit temperature range	-60 ... +105 °C
-------------------------	-----------------

UL/CSA approval pending

Additional information, see "Technical Section"

Approvals and corresponding ratings, visit www.wago.com

PCB Terminal Block ▶ 2606 Series

Push-in CAGE CLAMP® ▶ Actuation type: Lever ▶ 6 mm² ▶ Terminal strip ▶ Pin spacing: 12.5 mm (0.492 inch) ▶ Color: gray

Conductor entry angle to the PCB: 0°

Conductor entry angle to the PCB: 90°



Pole No.	Item No.	PU
2	2606-1352	
3	2606-1353	
4	2606-1354	
5	2606-1355	
6	2606-1356	
7	2606-1357	
8	2606-1358	
9	2606-1359	
10	2606-1360	
11	2606-1361	
12	2606-1362	

Pole No.	Item No.	PU
2	2606-3352	
3	2606-3353	
4	2606-3354	
5	2606-3355	
6	2606-3356	
7	2606-3357	
8	2606-3358	
9	2606-3359	
10	2606-3360	
11	2606-3361	
12	2606-3362	

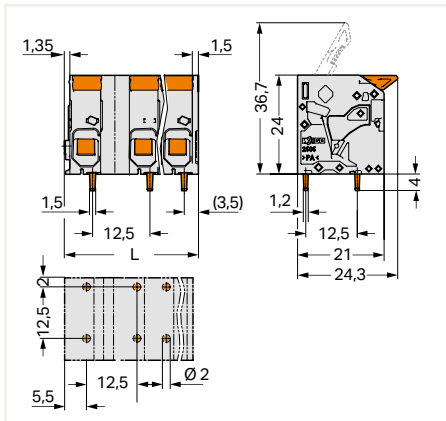

L = (pole no. - 1) x pin spacing + 9 mm

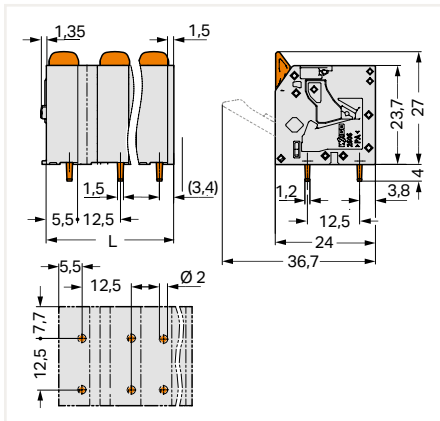

L = (pole no. - 1) x pin spacing + 9 mm

PU = Packaging Unit; SPU = Subpackaging Unit; Dimensions in mm

Other variants can be requested via the WAGO sales department or, if necessary, configured at <https://configurator.wago.com/>:

- Other pole numbers
- Direct marking
- Other colors

PCB Terminal Block ▶ 2616 Series

Push-in CAGE CLAMP® ▶ Actuation type: Lever ▶ 16 mm² ▶ Terminal strip ▶ Pin spacing: 15 mm (0.591 inch) ▶ Color: gray



- PCB terminal strips with lever-actuated Push-in CAGE CLAMP® connection
- Push-in termination of solid and ferruled conductors
- Intuitive and tool-free operation
- Several clamping units can be held open simultaneously – convenient for terminating multi-core cables
- Testing can be performed both parallel and perpendicular to conductor entry

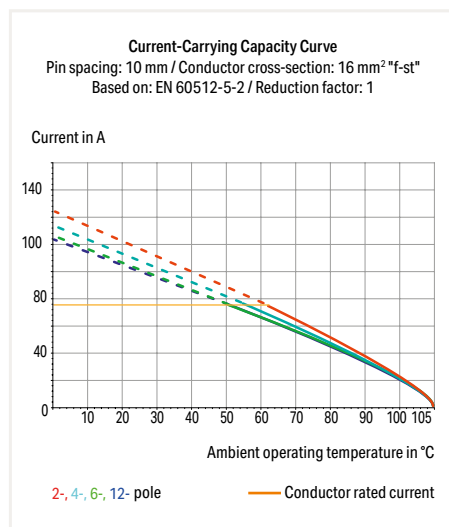

Electrical Data

Pin spacing	15 mm (0.591 inch)		
Ratings per	IEC/EN 60664-1		
Overvoltage category	III	III	II
Pollution degree	3	2	2
Rated voltage	800 V	1000 V	1000 V
Rated impulse voltage	8 kV	8 kV	8 kV
Rated current	76 A	76 A	76 A

Connection Data

Connection technology	Push-in CAGE CLAMP®
Strip length	18 ... 20 mm / 0.71 ... 0.79 inch
Solid conductor	0.75 ... 16 mm ² / 18 ... 4 AWG
Fine-stranded conductor	0.75 ... 25 mm ² / 18 ... 4 AWG
Fine-stranded conductor with ferrule with plastic collar	0.75 ... 16 mm ²
Fine-stranded conductor with ferrule without plastic collar	0.75 ... 16 mm ²
Fine-stranded conductor, with twin ferrule	0.75 ... 6 mm ²

Material Data

Material group	I
Insulating material	Polyamide 66 (PA 66)
Flammability class per UL94	V0
Clamping spring material	Chrome nickel spring steel (CrNi)
Contact material	Electrolytic copper (Ecu)
Contact plating	Tin-plated

Mechanical Data

Solder pin arrangement	Over the entire terminal strip, in line
Solder pin length	4 mm
Solder pin dimensions	1.5 x 1.2 mm
Drilled hole diameter (tolerance)	2 ^(+0.1) mm

Environmental Requirements

Limit temperature range	-60 ... +105 °C
-------------------------	-----------------

UL/CSA approval pending

Additional information, see "Technical Section"

Approvals and corresponding ratings, visit www.wago.com

PCB Terminal Block ▶ 2616 Series

Push-in CAGE CLAMP® ▶ Actuation type: Lever ▶ 16 mm² ▶ Terminal strip ▶ Pin spacing: 15 mm (0.591 inch) ▶ Color: gray

Conductor entry angle to the PCB: 0°

Conductor entry angle to the PCB: 90°

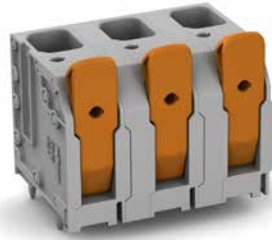
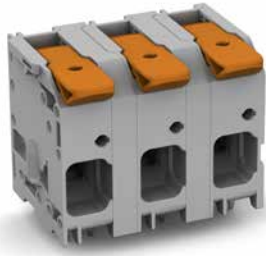

Pole No.	Item No.	PU
2	2616-1352	
3	2616-1353	
4	2616-1354	
5	2616-1355	
6	2616-1356	
7	2616-1357	
8	2616-1358	

Pole No.	Item No.	PU
2	2616-3352	
3	2616-3353	
4	2616-3354	
5	2616-3355	
6	2616-3356	
7	2616-3357	
8	2616-3358	

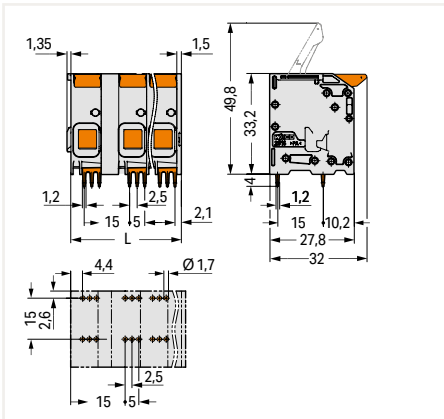

L = (pole no. - 1) x pin spacing + 11.5 mm

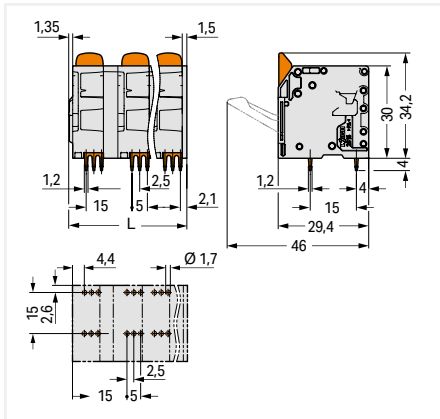

L = (pole no. - 1) x pin spacing + 11.5 mm

PU = Packaging Unit; SPU = Subpackaging Unit; Dimensions in mm

Other variants can be requested via the WAGO sales department or, if necessary, configured at <https://configurator.wago.com/>:

- Other pole numbers
- Direct marking
- Other colors

PCB Terminal Block ▶ 2626 Series

Push-in CAGE CLAMP® ▶ Actuation type: Operating tool ▶ 6 mm² ▶ Terminal strip ▶ Pin spacing: 12.5 mm (0.492 inch) ▶ Color: gray



- PCB terminal strips with Push-in CAGE CLAMP® connection
- Push-in termination of solid and ferruled conductors
- Ideal for panel feedthrough applications via operation parallel to conductor entry
- Testing can be performed both parallel and perpendicular to conductor entry

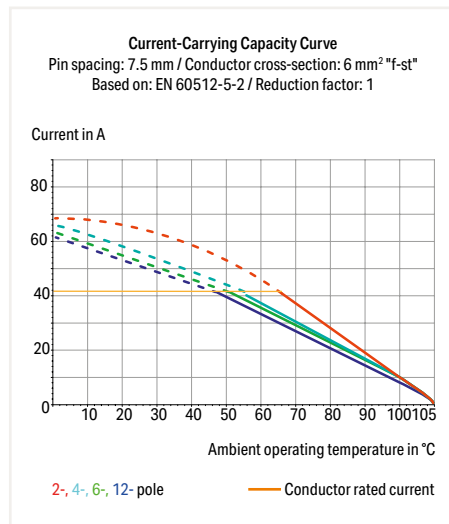

Electrical Data

Pin spacing	12.5 mm (0.492 inch)		
Ratings per	IEC/EN 60664-1		
Overvoltage category	III	III	II
Pollution degree	3	2	2
Rated voltage	800 V	1000 V	1000 V
Rated impulse voltage	8 kV	8 kV	8 kV
Rated current	41 A	41 A	41 A
Approvals per	UL 1059		
Use Group	B	C	D
Rated voltage	600 V	600 V	-
Rated current	38 A	38 A	-

Connection Data

Connection technology	Push-in CAGE CLAMP®
Strip length	13 ... 15 mm / 0.51 ... 0.59 inch
Solid conductor	0.2 ... 10 mm ² / 24 ... 8 AWG
Fine-stranded conductor	0.2 ... 10 mm ² / 24 ... 8 AWG
Fine-stranded conductor with ferrule with plastic collar	0.25 ... 6 mm ²
Fine-stranded conductor with ferrule without plastic collar	0.25 ... 6 mm ²
Fine-stranded conductor, with twin ferrule	0.25 ... 2.5 mm ²

Material Data

Material group	I
Insulating material	Polyamide 66 (PA 66)
Flammability class per UL94	V0
Clamping spring material	Chrome nickel spring steel (CrNi)
Contact material	Electrolytic copper (Ecu)
Contact plating	Tin-plated

Mechanical Data

Solder pin arrangement	Over the entire terminal strip, in line
Solder pin length	4 mm
Solder pin dimensions	1.5 x 1 mm
Drilled hole diameter (tolerance)	2 ^(±0.1) mm

Environmental Requirements

Limit temperature range	-60 ... +105 °C
-------------------------	-----------------

Additional information, see "Technical Section"

Approvals and corresponding ratings, visit www.wago.com

PCB Terminal Block ▶ 2626 Series

Push-in CAGE CLAMP® ▶ Actuation type: Operating tool ▶ 6 mm² ▶ Terminal strip ▶ Pin spacing: 12.5 mm (0.492 inch) ▶ Color: gray

Conductor entry angle to the PCB: 0°

Conductor entry angle to the PCB: 90°



Pole No.	Item No.	PU
2	2626-1352	
3	2626-1353	
4	2626-1354	
5	2626-1355	
6	2626-1356	
7	2626-1357	
8	2626-1358	
9	2626-1359	
10	2626-1360	
11	2626-1361	
12	2626-1362	

Pole No.	Item No.	PU
2	2626-3352	
3	2626-3353	
4	2626-3354	
5	2626-3355	
6	2626-3356	
7	2626-3357	
8	2626-3358	
9	2626-3359	
10	2626-3360	
11	2626-3361	
12	2626-3362	

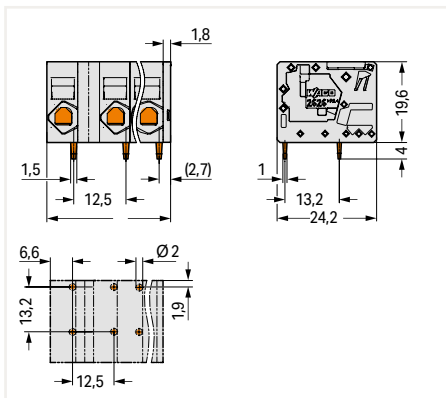

L = (pole no. - 1) x pin spacing + 9.3 mm

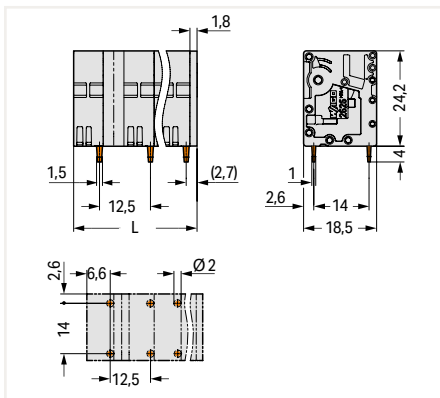

L = (pole no. - 1) x pin spacing + 9.3 mm

PU = Packaging Unit; SPU = Subpackaging Unit; Dimensions in mm

Other variants can be requested via the WAGO sales department or, if necessary, configured at <https://configurator.wago.com/>:

- Other pole numbers
- Direct marking
- Other colors

PCB Terminal Block ▶ 2636 Series

Push-in CAGE CLAMP® ▶ Actuation type: Operating tool ▶ 16 mm² ▶ Terminal strip ▶ Pin spacing: 15 mm (0.591 inch) ▶ Color: gray



- PCB terminal strips with Push-in CAGE CLAMP® connection
- Push-in termination of solid and ferruled conductors
- Ideal for panel feedthrough applications via operation parallel to conductor entry
- Testing can be performed both parallel and perpendicular to conductor entry

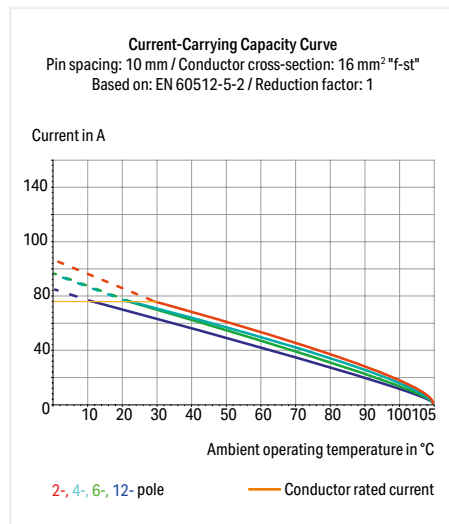

Electrical Data

Pin spacing	10 mm (0.394 inch)		
Ratings per	IEC/EN 60664-1		
Overvoltage category	III	III	II
Pollution degree	3	2	2
Rated voltage	1000 V	1000 V	1000 V
Rated impulse voltage	8 kV	8 kV	8 kV
Rated current	76 A	76 A	76 A

Connection Data

Connection technology	Push-in CAGE CLAMP®
Strip length	18 ... 20 mm / 0.71 ... 0.79 inch
Solid conductor	0.75 ... 16 mm ² / 18 ... 4 AWG
Fine-stranded conductor	0.75 ... 25 mm ² / 18 ... 4 AWG
Fine-stranded conductor with ferrule with plastic collar	0.75 ... 16 mm ²
Fine-stranded conductor with ferrule without plastic collar	0.75 ... 16 mm ²
Fine-stranded conductor, with twin ferrule	0.75 ... 6 mm ²

Material Data

Material group	I
Insulating material	Polyamide 66 (PA 66)
Flammability class per UL94	V0
Clamping spring material	Chrome nickel spring steel (CrNi)
Contact material	Electrolytic copper (Ecu)
Contact plating	Tin-plated

Mechanical Data

Solder pin arrangement	Over the entire terminal strip, in line
Solder pin length	4 mm
Solder pin dimensions	1.2 x 1 mm
Drilled hole diameter (tolerance)	1.7 ^(+0.1) mm

Environmental Requirements

Limit temperature range	-60 ... +105 °C
-------------------------	-----------------

UL/CSA approval pending

Additional information, see "Technical Section"

Approvals and corresponding ratings, visit www.wago.com

PCB Terminal Block ▶ 2636 Series

Push-in CAGE CLAMP® ▶ Actuation type: Operating tool ▶ 16 mm² ▶ Terminal strip ▶ Pin spacing: 15 mm (0.591 inch) ▶ Color: gray

Conductor entry angle to the PCB: 0°

Conductor entry angle to the PCB: 90°



Pole No.	Item No.	PU
2	2636-1352	
3	2636-1353	
4	2636-1354	
5	2636-1355	
6	2636-1356	
7	2636-1357	
8	2636-1358	

Pole No.	Item No.	PU
2	2636-3352	
3	2636-3353	
4	2636-3354	
5	2636-3355	
6	2636-3356	
7	2636-3357	
8	2636-3358	

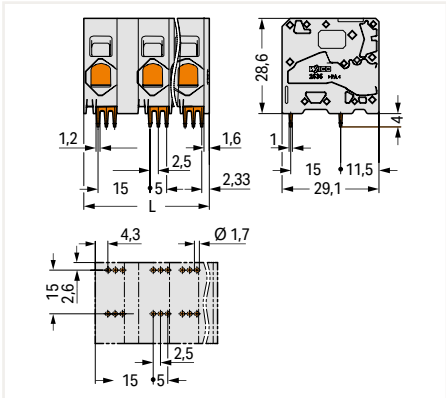

L = (pole no. - 1) x pin spacing + 11.6 mm

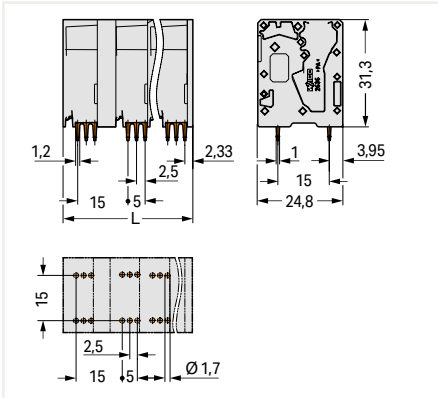

L = (pole no. - 1) x pin spacing + 11.6 mm

PU = Packaging Unit; SPU = Subpackaging Unit; Dimensions in mm

Other variants can be requested via the WAGO sales department or, if necessary, configured at <https://configurator.wago.com/>:

- Other pole numbers
- Direct marking
- Other colors

1-Conductor Female Connector ▶ MCS MAXI 6 ▶ 831 Series

Pin spacing: 7.62 mm (0.3 inch) ▶ Actuation type: Lever ▶ Push-in CAGE CLAMP® ▶ Color: light gray

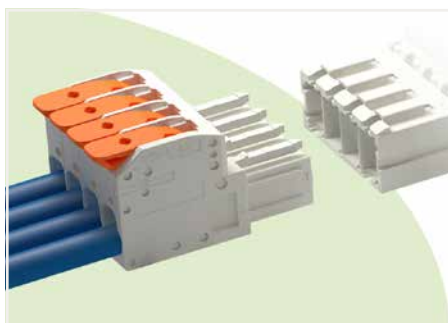

- Intuitive and tool-free lever actuation
- Universal connection for all conductor types
- Push-in terminations of solid and ferruled conductors
- Test slot 0° and 90° to conductor entry
- 100 % protected against mismatching
- Coding via coding fingers

Electrical Data

Ratings per	IEC/EN 60664-1		
Overvoltage category	III	III	II
Pollution degree	3	2	2
Rated voltage	800 V	1000 V	1000 V
Rated impulse voltage	8 kV	8 kV	8 kV
Rated current	41 A	41 A	41 A

Connection Data

Connection technology	Push-in CAGE CLAMP®
Strip length	13 ... 15 mm / 0.51 ... 0.59 inch
Solid conductor	0.5 ... 10 mm ² / 20 ... 8 AWG
Fine-stranded conductor	0.5 ... 10 mm ² / 20 ... 8 AWG
Fine-stranded conductor with ferrule with plastic collar	0.5 ... 6 mm ²
Fine-stranded conductor with ferrule without plastic collar	0.5 ... 6 mm ²

Material Data

Material group	I
Insulating material	Polyamide 66 (PA 66)
Flammability class per UL94	V0
Clamping spring material	Chrome nickel spring steel (CrNi)
Contact material	Electrolytic copper (Ecu)
Contact plating	Tin-plated

Environmental Requirements

Limit temperature range	-60 ... +105 °C
-------------------------	-----------------

The *MULTI CONNECTION SYSTEM (MCS)* is designed without breaking capacity for compliance with DIN EN 61984. When used as intended, MCS Connectors shall not be connected/disconnected when live or under load. The circuit design should ensure header pins, which can be touched, are not live when unmated.

Additional information, see "Technical Section"

Approvals and corresponding ratings, visit www.wago.com

1-Conductor Female Connector ▶ MCS MAXI 6 ▶ 831 Series

Pin spacing: 7.62 mm (0.3 inch) ▶ Actuation type: Lever ▶ Push-in CAGE CLAMP® ▶ Color: light gray



Pole No.	Item No.	PU
2	831-1102	48
3	831-1103	48
4	831-1104	24
5	831-1105	24
6	831-1106	24
7	831-1107	12
8	831-1108	12
9	831-1109	12

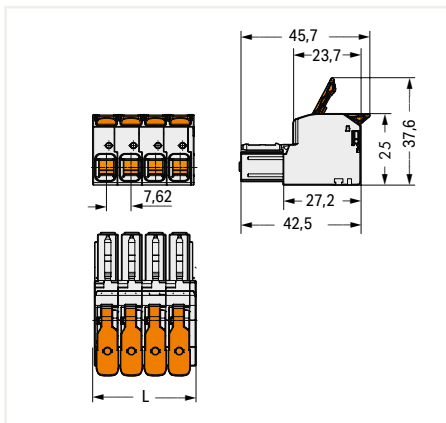

$L = (\text{pole no.} - 1) \times \text{pin spacing} + 9.5 \text{ mm}$

PU = Packaging Unit; SPU = Subpackaging Unit; Dimensions in mm

Other variants can be requested via the WAGO sales department or, if necessary, configured at <https://configurator.wago.com/>:

- Other pole numbers

1-Conductor Male Connector ▶ MCS MAXI 6 ▶ 831 Series

Pin spacing: 7.62 mm (0.3 inch) ▶ Actuation type: Lever ▶ Push-in CAGE CLAMP® ▶ Color: light gray

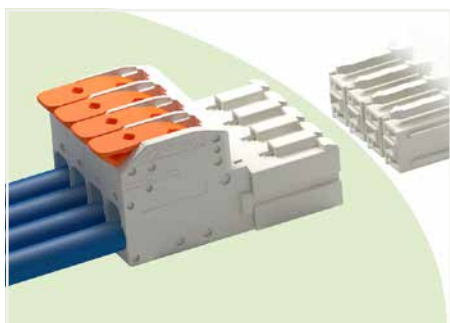

- Intuitive and tool-free lever actuation
- Universal connection for all conductor types
- Push-in terminations of solid and ferruled conductors
- Test slot 0° and 90° to conductor entry
- 100 % protected against mismatching
- Coding via coding fingers

Electrical Data

Ratings per	IEC/EN 60664-1		
Overvoltage category	III	III	II
Pollution degree	3	2	2
Rated voltage	800 V	1000 V	1000 V
Rated impulse voltage	8 kV	8 kV	8 kV
Rated current	41 A	41 A	41 A

Connection Data

Connection technology	Push-in CAGE CLAMP®
Strip length	13 ... 15 mm / 0.51 ... 0.59 inch
Solid conductor	0.5 ... 10 mm ² / 20 ... 8 AWG
Fine-stranded conductor	0.5 ... 10 mm ² / 20 ... 8 AWG
Fine-stranded conductor with ferrule with plastic collar	0.5 ... 6 mm ²
Fine-stranded conductor with ferrule without plastic collar	0.5 ... 6 mm ²

Material Data

Material group	I
Insulating material	Polyamide 66 (PA 66)
Flammability class per UL94	V0
Clamping spring material	Chrome nickel spring steel (CrNi)
Contact material	Electrolytic copper (Ecu)
Contact plating	Tin-plated

Environmental Requirements

Limit temperature range	-60 ... +105 °C
-------------------------	-----------------

The *MULTI CONNECTION SYSTEM (MCS)* is designed without breaking capacity for compliance with DIN EN 61984. When used as intended, MCS Connectors shall not be connected/disconnected when live or under load. The circuit design should ensure header pins, which can be touched, are not live when unmated.

Additional information, see "Technical Section"

Approvals and corresponding ratings, visit www.wago.com

1-Conductor Male Connector ▶ MCS MAXI 6 ▶ 831 Series

Pin spacing: 7.62 mm (0.3 inch) ▶ Actuation type: Lever ▶ Push-in CAGE CLAMP® ▶ Color: light gray



Pole No.	Item No.	PU
2	831-1202	48
3	831-1203	24
4	831-1204	24
5	831-1205	24
6	831-1206	24
7	831-1207	12
8	831-1208	12
9	831-1209	12

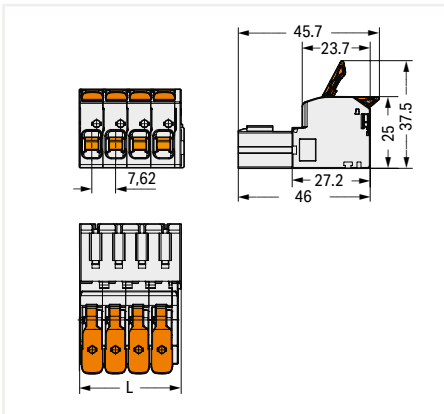

$L = (\text{pole no.} - 1) \times \text{pin spacing} + 9.5 \text{ mm}$

PU = Packaging Unit; SPU = Subpackaging Unit; Dimensions in mm

Other variants can be requested via the WAGO sales department or, if necessary, configured at <https://configurator.wago.com/>:

- Other pole numbers

THT Solder Pin Strip ▶ *picoMAX*[®] 3.5 ▶ 2091 Series

Pin spacing: 3.5 mm (0.138 inch) ▶ Color: black

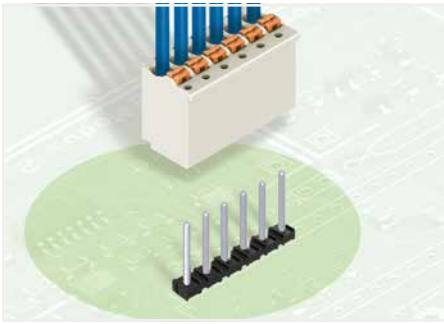

- Horizontal or vertical PCB mounting via straight or angled solder pin strips
- Assembly of female connectors without loss of poles, allowing different functions to be divided within solder pin strip

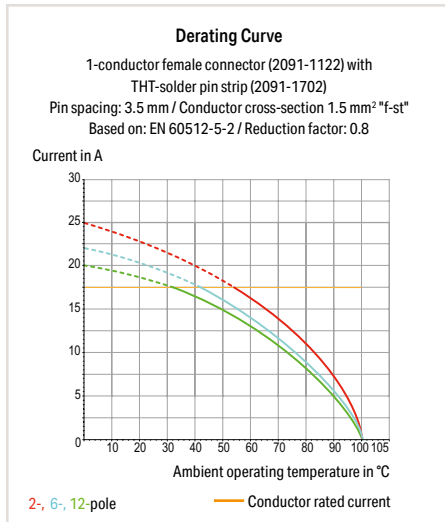

Electrical Data

Ratings per	IEC/EN 60664-1		
Overvoltage category	III	III	II
Pollution degree	3	2	2
Rated voltage	160 V	160 V	320 V
Rated impulse voltage	2.5 kV	2.5 kV	2.5 kV
Rated current	10 A	10 A	10 A

Material Data

Material group	I
Insulating material	Glass-fiber-reinforced polyphthalamide (PPA GF)
Flammability class per UL94	V0
Contact material	Electrolytic copper (Ecu)
Contact plating	Tin-plated

Mechanical Data

Solder pin length	3.6 mm
Solder pin diameter	1 mm
Drilled hole diameter (tolerance)	1.2 ^(+0.1) mm

Environmental Requirements

Limit temperature range	-60 ... +100 °C
-------------------------	-----------------

The *picoMAX*[®] Pluggable Connection System includes connectors without breaking capacity in accordance with DIN EN 61984. When used as intended, these connectors shall not be connected/disconnected when live or under load. The circuit design should ensure header pins, which can be touched, are not live when unmated.

Additional information, see "Technical Section"

Approvals and corresponding ratings, visit www.wago.com

THT Solder Pin Strip ▶ *picoMAX*® 3.5 ▶ 2091 Series

Pin spacing: 3.5 mm (0.138 inch) ▶ Color: black

Mating direction to the PCB: 90°

Mating direction to the PCB: 0°



Pole No.	Item No.	PU
2	2091-1702	600
3	2091-1703	600
4	2091-1704	600
5	2091-1705	400
6	2091-1706	400
7	2091-1707	400
8	2091-1708	400
10	2091-1710	400
12	2091-1712	400

Pole No.	Item No.	PU
2	2091-1722	400
3	2091-1723	400
4	2091-1724	400
5	2091-1725	400
6	2091-1726	400
7	2091-1727	400
8	2091-1728	400
10	2091-1730	300
12	2091-1732	300

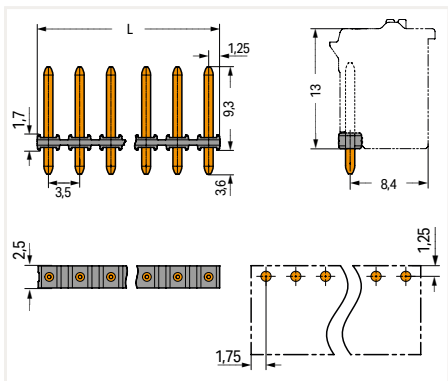

$L = (\text{pole no.} - 1) \times \text{pin spacing} + 2.5 \text{ mm}$

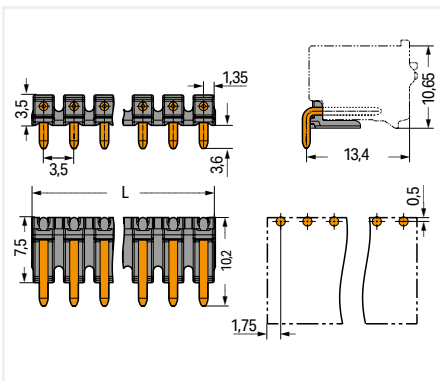

$L = (\text{pole no.} - 1) \times \text{pin spacing} + 2.7 \text{ mm}$

PU = Packaging Unit; SPU = Subpackaging Unit; Dimensions in mm

Other variants can be requested via the WAGO sales department or, if necessary, configured at <https://configurator.wago.com/>:

- Other pole numbers

THT Solder Pin Strip ▶ *picoMAX*[®] 5.0 ▶ 2092 Series

Pin spacing: 5 mm (0.197 inch) ▶ Color: black

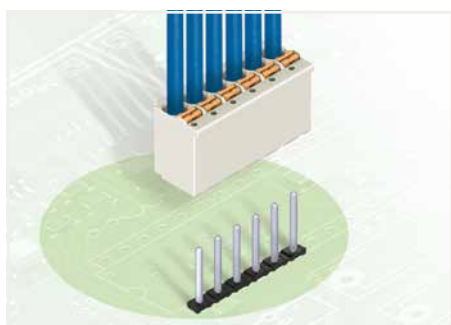

- Horizontal or vertical PCB mounting via straight or angled solder pin strips
- Assembly of female connectors without loss of poles, allowing different functions to be divided within solder pin strip

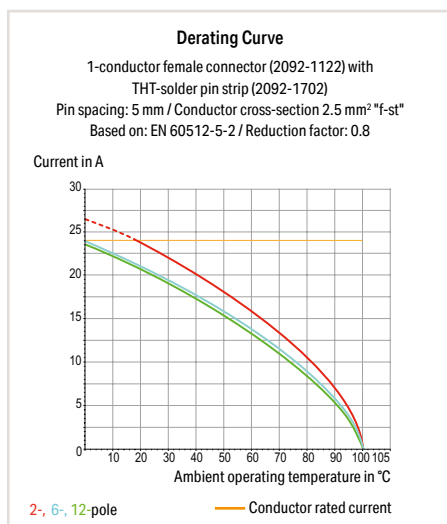

Electrical Data

Ratings per	IEC/EN 60664-1		
Overvoltage category	III	III	II
Pollution degree	3	2	2
Rated voltage	250 V	320 V	630 V
Rated impulse voltage	4 kV	4 kV	4 kV
Rated current	16 A	16 A	16 A

Material Data

Material group	I
Insulating material	Glass-fiber-reinforced polyphthalamide (PPA GF)
Flammability class per UL94	V0
Contact material	Electrolytic copper (Ecu)
Contact plating	Tin-plated

Mechanical Data

Solder pin length	3.6 mm
Solder pin diameter	1.4 mm
Drilled hole diameter (tolerance)	1.6 ^(+0.1) mm

Environmental Requirements

Limit temperature range	-60 ... +100 °C
-------------------------	-----------------

The *picoMAX*[®] Pluggable Connection System includes connectors without breaking capacity in accordance with DIN EN 61984. When used as intended, these connectors shall not be connected/disconnected when live or under load. The circuit design should ensure header pins, which can be touched, are not live when unmated.

Additional information, see "Technical Section"

Approvals and corresponding ratings, visit www.wago.com

THT Solder Pin Strip ▶ *picoMAX*® 5.0 ▶ 2092 Series

Pin spacing: 5 mm (0.197 inch) ▶ Color: black

Mating direction to the PCB: 90°

Mating direction to the PCB: 0°



Pole No.	Item No.	PU
2	2092-1702	400
3	2092-1703	400
4	2092-1704	400
5	2092-1705	400
6	2092-1706	400
7	2092-1707	400
8	2092-1708	400
9	2092-1709	300
10	2092-1710	300
12	2092-1712	300

Pole No.	Item No.	PU
2	2092-1722	300
3	2092-1723	300
4	2092-1724	300
5	2092-1725	300
6	2092-1726	300
7	2092-1727	300
8	2092-1728	300
9	2092-1729	300
10	2092-1730	200
12	2092-1732	200

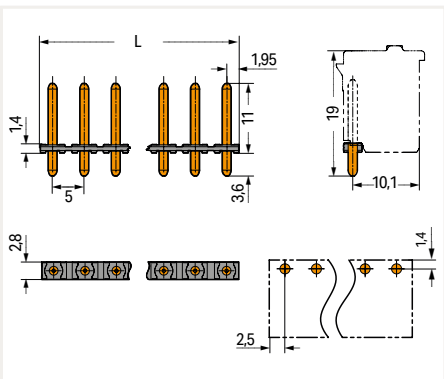

$L = (\text{pole no.} - 1) \times \text{pin spacing} + 3.9 \text{ mm}$

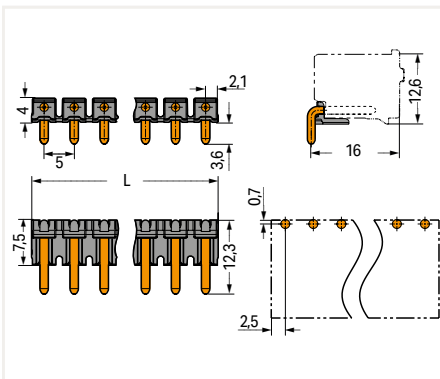

$L = (\text{pole no.} - 1) \times \text{pin spacing} + 4.2 \text{ mm}$

PU = Packaging Unit; SPU = Subpackaging Unit; Dimensions in mm

Other variants can be requested via the WAGO sales department or, if necessary, configured at <https://configurator.wago.com/>:

- Other pole numbers

THT Solder Pin Strip ▶ *picoMAX*[®] 7.5 ▶ 2092 Series

Pin spacing: 7.5 mm (0.295 inch) ▶ Color: black

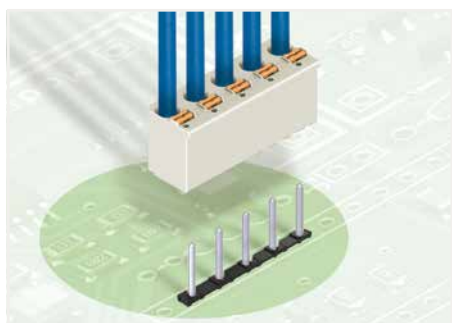

- Horizontal or vertical PCB mounting via straight or angled solder pin strips
- Assembly of female connectors without loss of poles, allowing different functions to be divided within solder pin strip

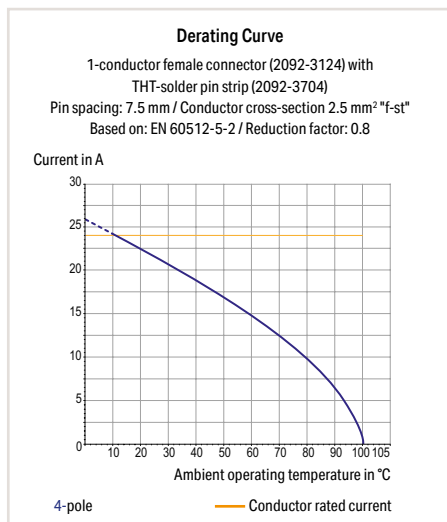

Electrical Data

Ratings per	IEC/EN 60664-1		
Overvoltage category	III	III	II
Pollution degree	3	2	2
Rated voltage	400 V	630 V	1000 V
Rated impulse voltage	6 kV	6 kV	6 kV
Rated current	16 A	16 A	16 A

Material Data

Material group	I
Insulating material	Glass-fiber-reinforced polyphthalamide (PPA GF)
Flammability class per UL94	V0
Contact material	Electrolytic copper (Ecu)
Contact plating	Tin-plated

Mechanical Data

Solder pin length	3.6 mm
Solder pin diameter	1.4 mm
Drilled hole diameter (tolerance)	1.6 ^(+0.1) mm

Environmental Requirements

Limit temperature range	-60 ... +100 °C
-------------------------	-----------------

The *picoMAX*[®] Pluggable Connection System includes connectors without breaking capacity in accordance with DIN EN 61984. When used as intended, these connectors shall not be connected/disconnected when live or under load. The circuit design should ensure header pins, which can be touched, are not live when unmated.

Additional information, see "Technical Section"

Approvals and corresponding ratings, visit www.wago.com

THT Solder Pin Strip ▶ *picoMAX*® 7.5 ▶ 2092 Series

Pin spacing: 7.5 mm (0.295 inch) ▶ Color: black

Mating direction to the PCB: 90°

Mating direction to the PCB: 0°



Pole No.	Item No.	PU
2	2092-3702	400
3	2092-3703	400
4	2092-3704	400
5	2092-3705	400

Pole No.	Item No.	PU
2	2092-3722	300
3	2092-3723	300
4	2092-3724	300
5	2092-3725	300

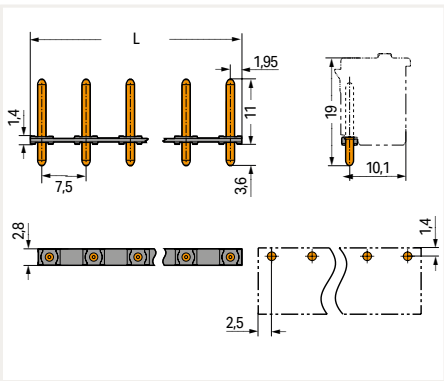

L = (pole no. - 1) x pin spacing + 3.9 mm

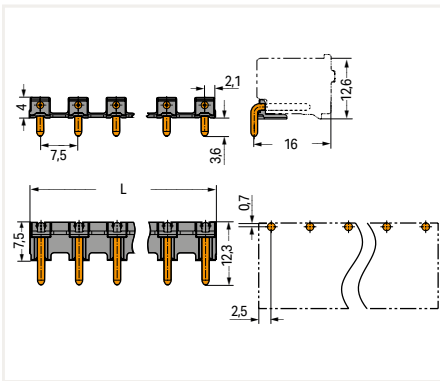

L = (pole no. - 1) x pin spacing + 4.2 mm

PU = Packaging Unit; SPU = Subpackaging Unit; Dimensions in mm

Other variants can be requested via the WAGO sales department or, if necessary, configured at <https://configurator.wago.com/>:

- Other pole numbers

THR Solder Pin Strip ▶ *picoMAX*[®] 3.5 ▶ 2091 Series

Pin spacing: 3.5 mm (0.138 inch) ▶ Color: black

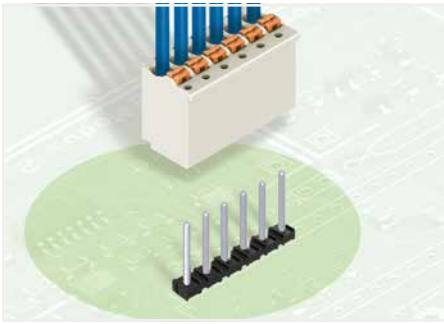

- Horizontal or vertical PCB mounting via straight or angled solder pin strips
- Assembly of female connectors without loss of poles, allowing different functions to be divided within solder pin strip

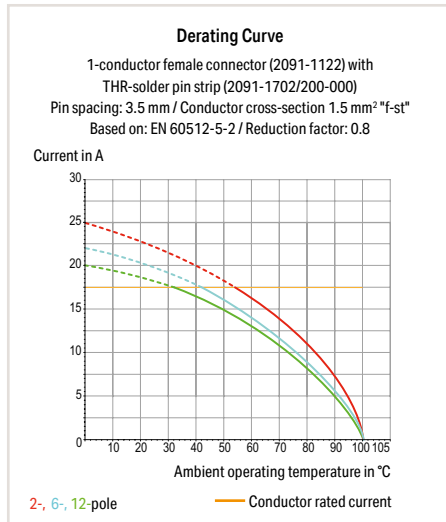

Electrical Data

Ratings per	IEC/EN 60664-1		
Overvoltage category	III	III	II
Pollution degree	3	2	2
Rated voltage	160 V	160 V	320 V
Rated impulse voltage	2.5 kV	2.5 kV	2.5 kV
Rated current	10 A	10 A	10 A

Material Data

Material group	I
Insulating material	Glass-fiber-reinforced polyphthalamide (PPA GF)
Flammability class per UL94	V0
Contact material	Electrolytic copper (Ecu)
Contact plating	Tin-plated

Mechanical Data

Solder pin length	2.4 mm
Solder pin diameter	1 mm
Plated through-hole diameter (THR)	1.2 ^(±0.1) mm

Environmental Requirements

Limit temperature range	-60 ... +100 °C
-------------------------	-----------------

The *picoMAX*[®] Pluggable Connection System includes connectors without breaking capacity in accordance with DIN EN 61984. When used as intended, these connectors shall not be connected/disconnected when live or under load. The circuit design should ensure header pins, which can be touched, are not live when unmated.

Additional information, see "Technical Section"

Approvals and corresponding ratings,
visit www.wago.com

THR Solder Pin Strip ▶ *picoMAX*® 3.5 ▶ 2091 Series

Pin spacing: 3.5 mm (0.138 inch) ▶ Color: black

Mating direction to the PCB: 90°

Mating direction to the PCB: 0°



Pole No.	Item No.	PU
2	2091-1702/200-000	600
3	2091-1703/200-000	600
4	2091-1704/200-000	600
5	2091-1705/200-000	400
6	2091-1706/200-000	400
7	2091-1707/200-000	400
8	2091-1708/200-000	400
10	2091-1710/200-000	400
12	2091-1712/200-000	400

Pole No.	Item No.	PU
2	2091-1722/200-000	400
3	2091-1723/200-000	400
4	2091-1724/200-000	400
5	2091-1725/200-000	400
6	2091-1726/200-000	400
7	2091-1727/200-000	400
8	2091-1728/200-000	400
10	2091-1730/200-000	300
12	2091-1732/200-000	300

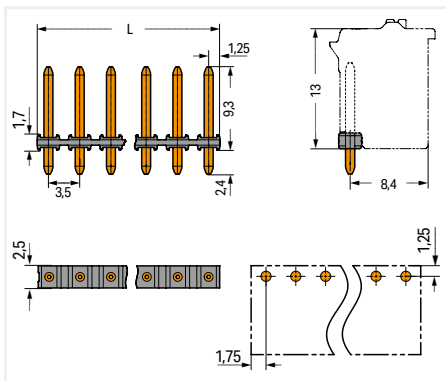

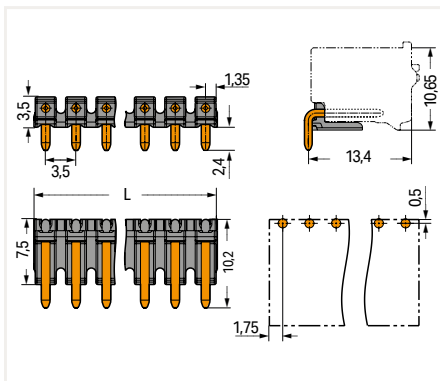
$$L = (\text{pole no.} - 1) \times \text{pin spacing} + 2.5 \text{ mm}$$

$$L = (\text{pole no.} - 1) \times \text{pin spacing} + 2.7 \text{ mm}$$

PU = Packaging Unit; SPU = Subpackaging Unit; Dimensions in mm

Other variants can be requested via the WAGO sales department or, if necessary, configured at <https://configurator.wago.com/>:

- Other pole numbers

THR Solder Pin Strip ▶ *picoMAX*[®] 5.0 ▶ 2092 Series

Pin spacing: 5 mm (0.197 inch) ▶ Color: black

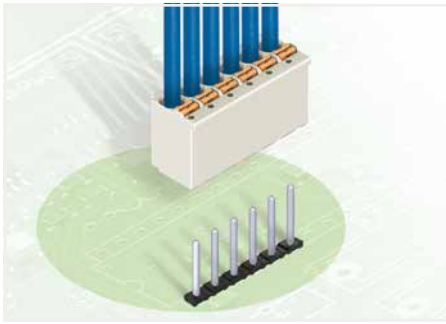

- Horizontal or vertical PCB mounting via straight or angled solder pin strips
- Assembly of female connectors without loss of poles, allowing different functions to be divided within solder pin strip

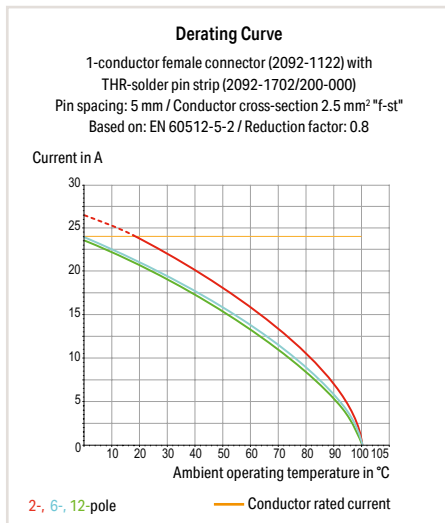

Electrical Data

Ratings per	IEC/EN 60664-1		
Overvoltage category	III	III	II
Pollution degree	3	2	2
Rated voltage	250 V	320 V	630 V
Rated impulse voltage	4 kV	4 kV	4 kV
Rated current	16 A	16 A	16 A

Material Data

Material group	I
Insulating material	Glass-fiber-reinforced polyphthalamide (PPA GF)
Flammability class per UL94	V0
Contact material	Electrolytic copper (Ecu)
Contact plating	Tin-plated

Mechanical Data

Solder pin length	2.4 mm
Solder pin diameter	1.4 mm
Plated through-hole diameter (THR)	1.6 ^(+0.1) mm

Environmental Requirements

Limit temperature range	-60 ... +100 °C
-------------------------	-----------------

The *picoMAX*[®] Pluggable Connection System includes connectors without breaking capacity in accordance with DIN EN 61984. When used as intended, these connectors shall not be connected/disconnected when live or under load. The circuit design should ensure header pins, which can be touched, are not live when unmated.

Additional information, see "Technical Section"

Approvals and corresponding ratings, visit www.wago.com

THR Solder Pin Strip ▶ *picoMAX*® 5.0 ▶ 2092 Series

Pin spacing: 5 mm (0.197 inch) ▶ Color: black

Mating direction to the PCB: 90°

Mating direction to the PCB: 0°



Pole No.	Item No.	PU
2	2092-1702/200-000	400
3	2092-1703/200-000	400
4	2092-1704/200-000	400
5	2092-1705/200-000	400
6	2092-1706/200-000	400
7	2092-1707/200-000	400
8	2092-1708/200-000	400
9	2092-1709/200-000	300
10	2092-1710/200-000	300
12	2092-1712/200-000	300

Pole No.	Item No.	PU
2	2092-1722/200-000	300
3	2092-1723/200-000	300
4	2092-1724/200-000	300
5	2092-1725/200-000	300
6	2092-1726/200-000	300
7	2092-1727/200-000	300
8	2092-1728/200-000	300
9	2092-1729/200-000	300
10	2092-1730/200-000	200
12	2092-1732/200-000	200

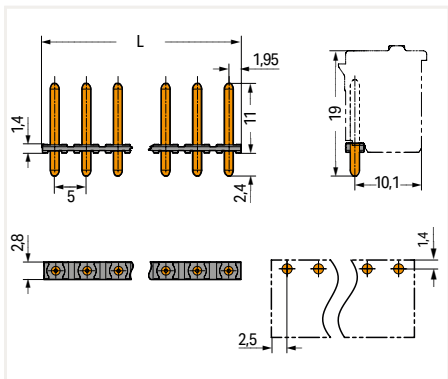

$L = (\text{pole no.} - 1) \times \text{pin spacing} + 3.9 \text{ mm}$

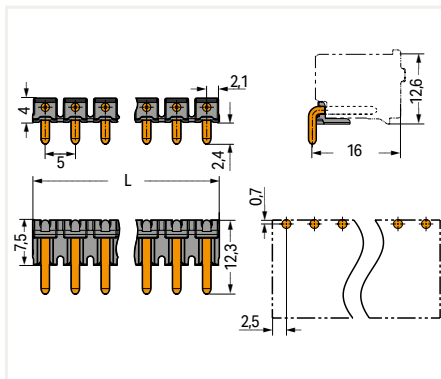

$L = (\text{pole no.} - 1) \times \text{pin spacing} + 4.2 \text{ mm}$

PU = Packaging Unit; SPU = Subpackaging Unit; Dimensions in mm

Other variants can be requested via the WAGO sales department or, if necessary, configured at <https://configurator.wago.com/>:

- Other pole numbers

THR Solder Pin Strip ▶ *picoMAX*[®] 7.5 ▶ 2092 Series

Pin spacing: 7.5 mm (0.295 inch) ▶ Color: black

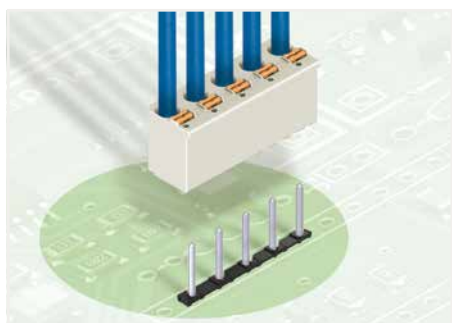

- Horizontal or vertical PCB mounting via straight or angled solder pin strips
- Assembly of female connectors without loss of poles, allowing different functions to be divided within solder pin strip

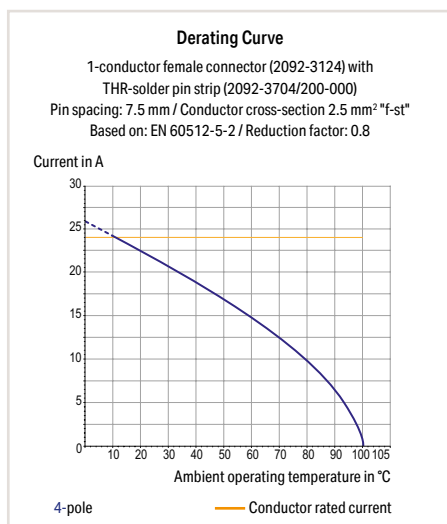

Electrical Data

Ratings per	IEC/EN 60664-1		
Overvoltage category	III	III	II
Pollution degree	3	2	2
Rated voltage	400 V	630 V	1000 V
Rated impulse voltage	6 kV	6 kV	6 kV
Rated current	16 A	16 A	16 A

Material Data

Material group	I
Insulating material	Glass-fiber-reinforced polyphthalamide (PPA GF)
Flammability class per UL94	V0
Contact material	Electrolytic copper (Ecu)
Contact plating	Tin-plated

Mechanical Data

Solder pin length	2.4 mm
Solder pin diameter	1.4 mm
Plated through-hole diameter (THR)	1.6 ^(+0.1) mm

Environmental Requirements

Limit temperature range	-60 ... +100 °C
-------------------------	-----------------

The *picoMAX*[®] Pluggable Connection System includes connectors without breaking capacity in accordance with DIN EN 61984. When used as intended, these connectors shall not be connected/disconnected when live or under load. The circuit design should ensure header pins, which can be touched, are not live when unmated.

Additional information, see "Technical Section"

Approvals and corresponding ratings,
visit www.wago.com

THR Solder Pin Strip ▶ *picoMAX*® 7.5 ▶ 2092 Series

Pin spacing: 7.5 mm (0.295 inch) ▶ Color: black

Mating direction to the PCB: 90°

Mating direction to the PCB: 0°



Pole No.	Item No.	PU
2	2092-3702/200-000	400
3	2092-3703/200-000	400
4	2092-3704/200-000	400
5	2092-3705/200-000	400

Pole No.	Item No.	PU
2	2092-3722/200-000	300
3	2092-3723/200-000	300
4	2092-3724/200-000	300
5	2092-3725/200-000	300

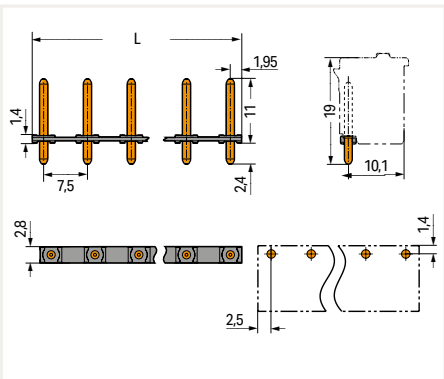

L = (pole no. - 1) x pin spacing + 3.9 mm

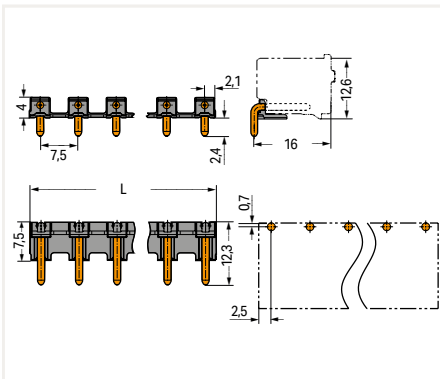

L = (pole no. - 1) x pin spacing + 4.2 mm

PU = Packaging Unit; SPU = Subpackaging Unit; Dimensions in mm



Other variants can be requested via the WAGO sales department or, if necessary, configured at <https://configurator.wago.com/>:

- Other pole numbers



Volume 6, WAGO Marking

Volume 6, WAGO Marking

		Page
	WAGO Marking Software Smart Script	54
	WAGO Configuration Software Smart Designer	55

WAGO Marking Software Smart Script Intuitive Marking Software

Smart Script is WAGO's new software for the compact Thermal Transfer Smart Printer. The self-explanatory and intuitive software perfectly fits all control cabinet marking requirements.

Combining superior usability with a modern design, Smart Script helps the user complete the task quickly and easily with just a few clicks. For example, Smart Script can be used to easily customize type labels, as well as define and print barcodes and graphic elements.

- **Modern design:**
Appealing and intuitive workflow
- **All applications in one Software:**
Fast and easy to use, printer driver and all settings integrated
- **For any control cabinet marking application:**
Professional marking of terminal blocks, labels, type plates and conductor markers



WAGO Configuration Software Smart Designer

Smart Designer in HTML5

Updated to HTML5, WAGO's Smart Designer Configuration Software comes with a new design and additional features.

The new software offers a modern and intuitive user interface for maximum usability. In addition, mobile devices are better supported, expanding the scope of applications and allowing the software to be used at any time and from anywhere. With this future-ready web application standard, WAGO offers a tool that perfectly supports the engineering process.

All known and proven functions of the previous Smart Designer version have been retained. The updated tool allows projects from different CAE planning tools to be imported via an interface and, for example, a plausibility check to be performed. Based on WAGO's expertise, a check is made as to whether the configured setup is possible and for rail-mount terminal blocks, e.g., the correct jumpers are set according to the planning. Alternatively, a combination of rail-mount terminal blocks or a custom connector can be created directly in the software and an offer can be requested with a click.

- Future-ready web application standard
- Modern, intuitive user interface
- Better support for mobile devices
- All known functions have been retained

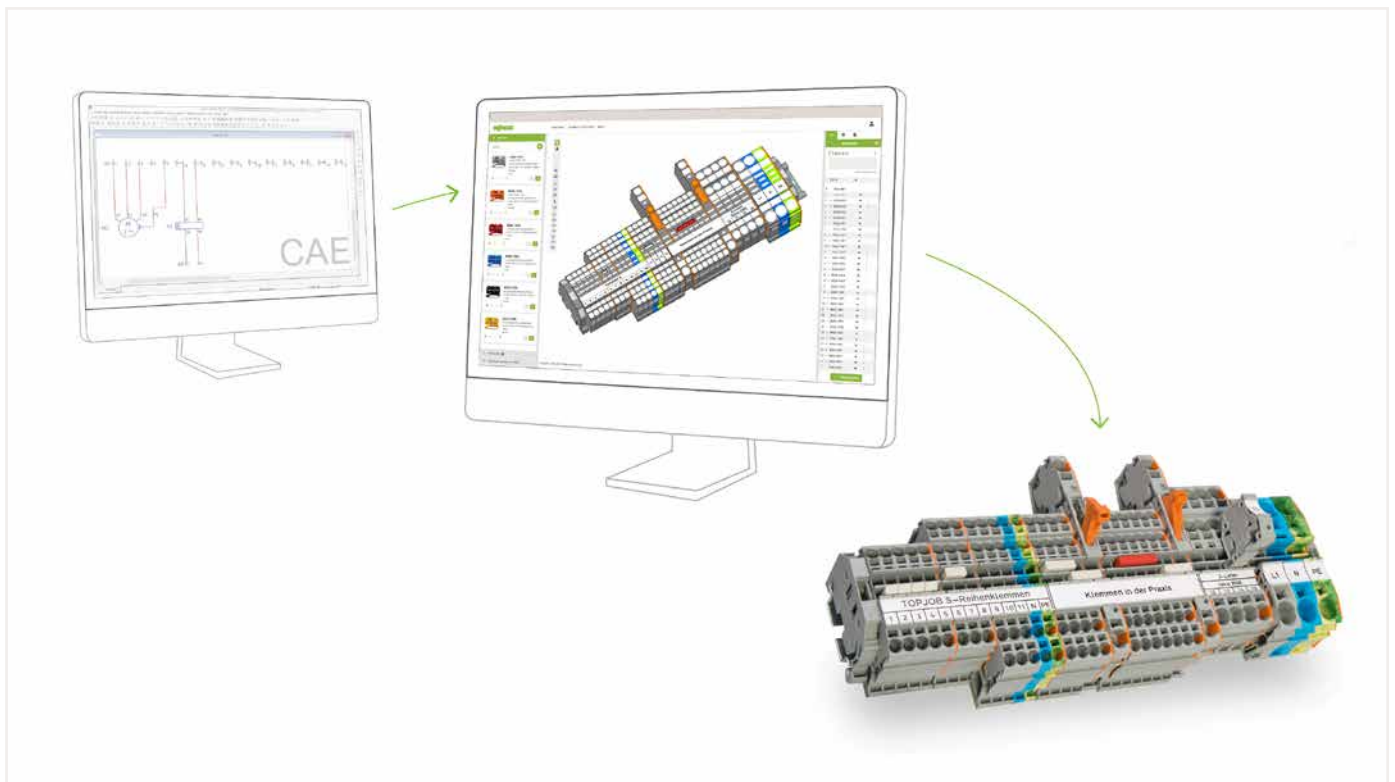

Cable Stripper

Never use this tool on or near live electrical circuits!



Cable knife; for \varnothing 8 ... 28 mm / 0.31 ... 1.10 inch; with a unique, changeable cable bracket system; including cable bracket

	Item No.	Pack. Unit
	206-1403	1

Cable knife set; for \varnothing 4 ... 70 mm / 0.16 ... 2.75 inch; including all cable brackets in a Sortimo® Box

	Item No.	Pack. Unit
	206-1400	1

Item-Specific Accessories

Cable bracket; for \varnothing 4 ... 16 mm / 0.16 ... 0.63 inch

206-1411	1
----------	---

Cable bracket; for \varnothing 8 ... 28 mm / 0.31 ... 1.10 inch

206-1412	1
----------	---

Cable bracket; for \varnothing 27 ... 35 mm / 1.06 ... 1.38 inch

206-1413	1
----------	---

Cable bracket; for \varnothing 35 ... 50 mm / 1.38 ... 1.97 inch

206-1414	1
----------	---

Cable bracket; for \varnothing 50 ... 70 mm / 1.97 ... 2.75 inch

206-1415	1
----------	---

Accessories

Spare inside blade

206-1418	3
----------	---

Spare hook blade

206-1419	1
----------	---



Cable Stripper



In-socket cable stripper; for \varnothing 8 ... 13 mm / 5/16 ... 1/2 inch

	Item No.	Pack. Unit
	206-1441	1



Universal cable stripper; for \varnothing 8 ... 13 mm / 5/16 ... 1/2 inch

	Item No.	Pack. Unit
	206-1442	1



Data cable stripper; for \varnothing 4.5 ... 10 mm / 3/16 ... 3/8 inch

	Item No.	Pack. Unit
	206-1451	1



Product features:

- Extra long design and improved force transmission simplifies stripping in deep device connection sockets
- Special four-blade design for an even more precise round cut
- No cutting depth adjustment required
- TiN-coated blades, TÜV/GS tested
- \varnothing 8 ... 13 mm / 5/16 ... 1/2 inch
- Strips all standard round cables, including NYM 3 x 1.5 mm²/16 AWG ... 5 x 2.5 mm²/14 AWG



Sheath stripping: longitudinal cut

Product features:

- Secure grip achieved with soft padding for non-slip grips
- Technically improved functionality
- New locking mechanism prevents the unwanted opening of the tool
- Absolutely straightforward, quick and easy longitudinal cuts – with innovative internal cable duct
- Redesigned blade layout and intake to stop cable waste from jamming the tool
- Durable and ergonomically designed pocket clip
- \varnothing 8 ... 13 mm / 5/16 ... 1/2 inch



Product features:

- Strip outer insulation and foil sheathing with one tool
- Ideal for stripping PVC-insulated data cables with thin insulation (e.g., Cat. 5, Cat. 6, Cat. 7, twisted pair cable)
- TiN-coated blades
- \varnothing 4.5 ... 10 mm / 3/16 ... 3/8 inch



Stripping a cable sheath.



Built-in handy knife



Stripping a wire insulation.

Cable Stripper



Never use this tool on or near live electrical circuits!

The stripping pliers for sensor cables have a blade geometry specially designed for sensor cables with a smaller cross section and a working range from Ø 3.2 mm / 0.13 inch (for stranded cables and round cables with Ø 3.2 mm ... 4.4 mm / 0.13 ... 0.17 inch).

The stripping pliers for control cables are designed for stronger cables from Ø 4.4 mm / 0.17 inch (for stranded cables and round cables with Ø 4.4 mm ... 7 mm / 0.17 ... 0.27 inch).

These stripping pliers quickly and safely strip cables for connecting, e.g., sensor/actuator distribution boxes, bus couplers and pluggable connectors.

Stripping pliers; for sensor cables; for Ø 3.2 ... 4.4 mm / 0.13 ... 0.17 inch

Item No.	Pack. Unit
206-1481	1

Stripping pliers; for control cables; for Ø 4.4 ... 7 mm / 0.17 ... 0.27 inch

Item No.	Pack. Unit
206-1482	1

Item-Specific Accessories

Replacement blade set; for Ø 3.2 ... 4.4 mm / 0.13 ... 0.17 inch

206-1491	1
----------	---

Item-Specific Accessories

Replacement blade set; for Ø 4.4 ... 7 mm / 0.17 ... 0.27 inch

206-1492	1
----------	---

Suitable for:

- Halogen-free PUR sensor/actuator cables
- Highly flexible TPE-U cables
- Control cables
- PUR cables
- PUR/PVC cables
- PVC cables
- Multi-core cables
- Shielded and unshielded cables



Wire Stripper



Wire stripper "Quickstrip Vario"; 0.03 ... 16 mm² / 34 ... 6 AWG; with wire cutter

	Item No.	Pack. Unit
	206-1125	1

Accessories

Blade set; Standard; 0.03 ... 16 mm² / 34 ... 6 AWG

206-1126 1

Blade set; V-blade; 0.14 ... 4 mm² / 24 ... 12 AWG

206-1127 1

Blade set; Oval blade; 10 ... 16 mm² / 8 ... 6 AWG

206-1128 1

Spare stripping stop

206-1129 1

Spare cut protector

206-1131 1

Spare clamping jaws

206-1132 1

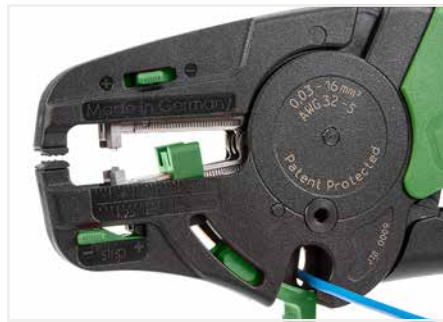

Cutting a conductor.



Partially stripping a conductor.

Wire Stripper:

- Automatically adjust to conductor size
- Stripping blades cause no damage to conductor strands
- Gripping pressure of jaws adjusts automatically to conductor insulation diameter
- Clamping jaws and stripping blades automatically open once the stripping process is completed – no splaying of the conductor strands
- Exact strip length may be set by sliding black setting stop
- Stripping blades can be replaced
- Self-sharpening, fully protected cutter (replaceable)
- Entire body made of glass-fiber-reinforced polyamide
- Cutting capacity of the wire cutter of fine-stranded conductors up to 16 mm² (6 AWG)

Crimping Tool



Crimping tool "Variocrimp 4"; for insulated and uninsulated ferrules; Crimping range: 0.25 ... 4 mm² (24 ... 12 AWG)

Item No.	Pack. Unit
206-1204	1

Crimping tool "Variocrimp 16"; for insulated and uninsulated ferrules; Crimping range: 6 mm² (10 AWG), 10 mm² (8 AWG) and 16 mm² (6 AWG)

Item No.	Pack. Unit
206-1216	1

Spring clamp; large

206-1205	1
----------	---

Spring clamp; small

206-1206	1
----------	---

Spring clamp; small

206-1206	1
----------	---

PUR spring set

206-1207	1
----------	---

Application notes:

- The built-in crimping pressure control of "Variocrimp 4" automatically adjusts the crimping force to the conductor cross section. Select the wire gauge on "Variocrimp 16" before crimping.
- Only one crimping station is needed to handle the specified conductor range.
- Uniform, compact crimping on all four sides for high conductor retention.
- No need to center the ferrules into the terminal blocks.
- Crimping can be performed from either side (for left- or right-handed users).
- Built-in ratchet mechanism ensures gas-tight crimp connection.
- Crimping tools open automatically after crimping operation is complete.
- Ergonomically designed handles.

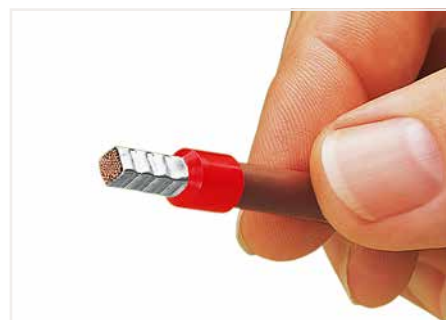

A perfect gas-tight crimp – both electrically and mechanically reliable



Insert the ferruled conductor into the crimping station.



Squeeze handles until ratchet mechanism is released.



Only for "Variocrimp 16":
Adjust conductor cross section with crimping tool in open position.

Crimping Tool



Crimping tool 25; for insulated and uninsulated ferrules; crimping range: 10 mm² (8 AWG), 16 mm² (6 AWG) and 25 mm² (4 AWG)

	Item No.	Pack. Unit
	206-1225	1



Crimping tool 50; for insulated and uninsulated ferrules; crimping range: 35 mm² (2 AWG) and 50 mm² (1/0 AWG)

	Item No.	Pack. Unit
	206-1250	1

Application notes:

- Improved crimping for higher conductor retention
- Crimping can be performed from either side (for left- or right-handed users).
- Built-in ratchet mechanism ensures gas-tight crimp connection.
- Crimping tools open automatically after crimping operation is complete.
- Ergonomically designed handles.



Insert the ferruled conductor into the crimping station.



Squeeze handles until ratchet mechanism is released.

What is a "gas-tight" connection?

In a gas-tight connection, the conductor and the ferrule are compressed, eliminating all spaces. Under normal atmospheric conditions, neither a liquid nor gaseous medium can penetrate the crimped connection. Oxidation between crimped single conductors is prevented, virtually eliminating the possibility of any increase in the crimped connection's resistance. In some exceptional cases, minute, isolated spaces may be present. However, these instances can be considered as closed off due to the twisted conductor. Inadequate crimping can allow the conductor to be pulled out of the connection. Hollow spaces also remain, permitting oxidation formation and an increase in contact resistance.

Elevated resistance is detrimental for both signal transmission (signal flow is damped) and power transmission, resulting in power loss and contact heating (risk of fire). Crimping tools with built-in ratchets are recommended (e.g., WAGO Crimping Tools). These tools open automatically after the crimping operation is complete. Space-saving crimping from all four sides is ideal for spring clamp termination.

Ferruled conductor cross sections specified for WAGO products are based on this crimping method.

Item Number Index

Item No.	Page	Item No.	Page	Item No.	Page	Item No.	Page
206 Series		831 Series		2002 Series		2022 Series	
206-1125	57	831-1102	37	2002-1791	10	2022-1801	23
206-1126	57	831-1103	37	2002-1792	10	2022-1802	23
206-1127	57	831-1104	37			2022-1804	23
206-1128	57	831-1105	37	2002-1891	12	2022-1807	23
206-1129	57	831-1106	37	2002-1892	12	2022-1891	23
206-1131	57	831-1107	37			2022-1892	23
206-1132	57	831-1108	37	2002-1991	18		
		831-1109	37	2002-1992	18	2091 Series	
206-1204	58					2091-1702	41
206-1205	58	831-1202	39	2004 Series		2091-1702/200-000	47
206-1206	58	831-1203	39	2004-402	16	2091-1703	41
206-1207	58	831-1204	39	2004-403	16	2091-1703/200-000	47
206-1216	58	831-1205	39	2004-404	16	2091-1704	41
206-1225	59	831-1206	39	2004-405	16	2091-1704/200-000	47
206-1250	59	831-1207	39	2004-406	16	2091-1705	41
		831-1208	39	2004-407	16	2091-1705/200-000	47
206-1400	54	831-1209	39	2004-408	16	2091-1706	41
206-1403	54			2004-409	16	2091-1706/200-000	47
206-1411	54	2002 Series		2004-410	16	2091-1707	41
206-1412	54	2002-115	8	2004-410	16	2091-1707/200-000	47
206-1413	54	2002-121	6	2004-433	16	2091-1708	41
206-1414	54	2002-171	6	2004-434	16	2091-1708/200-000	47
206-1415	54	2002-172	6	2004-435	16	2091-1710	41
206-1418	54			2004-436	16	2091-1710/200-000	47
206-1419	54	2002-400	8	2004-437	16	2091-1712	41
206-1441	55	2002-402	6	2004-438	16	2091-1712/200-000	47
206-1442	55	2002-403	6	2004-439	16	2091-1722	41
206-1451	55	2002-404	6	2004-440	16	2091-1722/200-000	47
206-1481	56	2002-405	6			2091-1723	41
206-1482	56	2002-405/011-000	8	2006 Series		2091-1723/200-000	47
206-1491	56	2002-406	6	2006-7300	7	2091-1724	41
206-1492	56	2002-406/020-000	8			2091-1724/200-000	47
		2002-407	6	2009 Series		2091-1725	41
209 Series		2002-408	6	2009-110	4	2091-1725/200-000	47
209-105	7	2002-409	6	2009-115	9	2091-1726	41
		2002-410	6	2009-174	4	2091-1726/200-000	47
210 Series		2002-415	23	2009-182	9	2091-1727	41
210-133	7	2002-423	8			2091-1727/200-000	47
210-136	7	2002-423/000-005	8	2009-304	7	2091-1728	41
210-137	7	2002-423/000-006	8	2009-305	7	2091-1728/200-000	47
		2002-433	6			2091-1730	41
210-281	7	2002-434	6	2009-412	8	2091-1730/200-000	47
		2002-435	6	2009-414	8	2091-1732	41
210-334	25	2002-436	6	2009-416	8	2091-1732/200-000	47
		2002-437	6			2092 Series	
215 Series		2002-438	6	2010 Series		2092-1702	43
215-111	9	2002-439	6	2010-100	4	2092-1702/200-000	49
		2002-440	6	2010-115	4	2092-1703	43
221 Series		2002-472	8			2092-1703/200-000	49
221-482	25	2002-473	8	2010-402	4	2092-1704	43
221-483	25	2002-473/011-000	8	2010-403	4	2092-1704/200-000	49
221-485	25	2002-474	8	2010-404	4	2092-1705	43
		2002-475	8	2010-405	4	2092-1705/200-000	49
221-501	25	2002-475/011-000	8	2010-405/011-000	4	2092-1706	43
		2002-476	8			2092-1706/200-000	49
249 Series		2002-477	8	2010-433	4	2092-1707	43
249-116	23	2002-477/011-000	8	2010-434	4	2092-1707/200-000	49
249-117	23	2002-478	8	2010-435	4	2092-1708	43
		2002-479	8			2092-1708/200-000	49
777 Series		2002-479/011-000	8	2010-511	4	2092-1709	43
777-303	7	2002-480	8			2092-1709/200-000	49
		2002-481	8	2010-7111	7	2092-1710	43
793 Series		2002-481/011-000	8	2010-7114	7	2092-1710/200-000	49
793-5501	4	2002-482	8	2010-7192	7	2092-1712	43
793-5501/000-002	23	2002-492	6			2092-1712/200-000	49
793-5501/000-005	23	2002-492/000-012	6	2022 Series		2092-1722	43
793-5501/000-006	23			2022-100	23	2092-1722/200-000	49
793-5501/000-007	23	2002-511	8	2022-101	23	2092-1723	43
793-5501/000-012	23	2002-541	8			2092-1723/200-000	49
793-5501/000-017	23	2002-549	8	2022-1601	23	2092-1724	43
793-5501/000-023	23	2002-611	9	2022-1602	23	2092-1724/200-000	49
793-5501/000-024	23	2002-641	9	2022-1604	23	2092-1725	43
		2002-649	9	2022-1607	23	2092-1725/200-000	49
				2022-1691	23	2092-1726	43
		2002-991	16	2022-1692	23	2092-1726/200-000	49
		2002-992	16			2092-1727	43
						2092-1727/200-000	49
		2002-1691	8			2092-1728	43
		2002-1692	8			2092-1728/200-000	49
						2092-1729	43

Item No.	Page	Item No.	Page	Item No.	Page	Item No.	Page
2092 Series		2202 Series		2616 Series			
2092-1729/200-000	49	2202-1811/1000-542	16	2616-3355	31		
2092-1730	43	2202-1811/1000-836	16	2616-3356	31		
2092-1730/200-000	49	2202-1811/1000-867	16	2616-3357	31		
2092-1732	43	2202-1861	12	2616-3358	31		
2092-1732/200-000	49	2202-1871	12				
		2202-1872	12				
2092-3702	45	2202-1874	12	2626 Series			
2092-3702/200-000	51	2202-1881	14	2626-1352	33		
2092-3703	45			2626-1353	33		
2092-3703/200-000	51	2202-1901	18	2626-1354	33		
2092-3704	45	2202-1902	18	2626-1355	33		
2092-3704/200-000	51	2202-1904	18	2626-1356	33		
2092-3705	45	2202-1907	18	2626-1357	33		
2092-3705/200-000	51	2202-1911	22	2626-1358	33		
2092-3722	45	2202-1911/1000-541	22	2626-1359	33		
2092-3722/200-000	51	2202-1911/1000-542	22	2626-1360	33		
2092-3723	45	2202-1911/1000-836	22	2626-1361	33		
2092-3723/200-000	51	2202-1911/1000-867	22	2626-1362	33		
2092-3724	45	2202-1961	18				
2092-3724/200-000	51	2202-1971	18	2626-3352	33		
2092-3725	45	2202-1972	18	2626-3353	33		
2092-3725/200-000	51	2202-1974	18	2626-3354	33		
		2202-1981	20	2626-3355	33		
2110 Series		2202-1981/1000-413	20	2626-3356	33		
2110-1201	4	2202-1981/1000-414	20	2626-3357	33		
2110-1204	4	2202-1981/1000-429	20	2626-3358	33		
2110-1207	4	2202-1981/1000-434	20	2626-3359	33		
2110-1291	4	2202-1981/1000-435	20	2626-3360	33		
2110-1292	4	2202-1981/1000-449	20	2626-3361	33		
				2626-3362	33		
2110-1301	4	2202-2701	6				
2110-1304	4	2202-2702	6	2636 Series			
2110-1307	4	2202-2703	6	2636-1352	35		
2110-1391	4	2202-2704	6	2636-1353	35		
2110-1392	4	2202-2707	6	2636-1354	35		
		2202-2708	6	2636-1355	35		
2110-5201	5	2202-2709	6	2636-1356	35		
2110-5204	5	2202-2717	6	2636-1357	35		
2110-5207	5	2202-2727	6	2636-1358	35		
		2202-2791	6				
2110-5301	5	2202-2792	6	2636-3352	35		
2110-5304	5			2636-3353	35		
2110-5307	5			2636-3354	35		
		2606 Series		2636-3355	35		
2202 Series		2606-1352	29	2636-3356	35		
2202-1601	8	2606-1353	29	2636-3357	35		
2202-1602	8	2606-1354	29	2636-3358	35		
2202-1604	8	2606-1355	29				
2202-1611	16	2606-1356	29				
2202-1611/1000-541	16	2606-1357	29				
2202-1611/1000-542	16	2606-1358	29				
2202-1611/1000-836	16	2606-1359	29				
2202-1611/1000-867	16	2606-1360	29				
2202-1661	8	2606-1361	29				
2202-1662	8	2606-1362	29				
2202-1671	8						
2202-1672	8	2606-3352	29				
2202-1674	8	2606-3353	29				
2202-1681	14	2606-3354	29				
		2606-3355	29				
2202-1701	10	2606-3356	29				
2202-1702	10	2606-3357	29				
2202-1704	10	2606-3358	29				
2202-1707	10	2606-3359	29				
2202-1711	16	2606-3360	29				
2202-1711/1000-541	16	2606-3361	29				
2202-1711/1000-542	16	2606-3362	29				
2202-1711/1000-836	16						
2202-1711/1000-867	16	2616 Series					
2202-1761	10	2616-1352	31				
2202-1771	10	2616-1353	31				
2202-1772	10	2616-1354	31				
2202-1774	10	2616-1355	31				
2202-1781	14	2616-1356	31				
		2616-1357	31				
2202-1801	12	2616-1358	31				
2202-1802	12						
2202-1804	12	2616-3352	31				
2202-1811	16	2616-3353	31				
2202-1811/1000-541	16	2616-3354	31				

WAGO Worldwide Companies and Representatives

Algeria

please contact WAGO France

Argentina

Bruno Schillig S.A.
Arenales 4030, B1604CFD
Florida, PBA
Phone +54 11 4730 1100
Fax +54 11 4761 7244
wago@schillig.com.ar

Armenia

ROOT ITSP LLC
33 Halabyan str.
0038, Yerevan
info@root.am

Australia

WAGO Pty. Ltd.
2-4 Overseas Drive
Noble Park Victoria 3174
Phone +61 03 8791 6300
Fax +61 03 9701 0177
sales.anz@wago.com

NHP ELECTRICAL ENGINEERING

PRODUCTS PTY LTD
43-67 River Street
Richmond, Victoria, 3121
P.O. Box 199
Phone +61 3 9429 2999
Fax +61 3 9429 1075
export@wago.com

Austria

WAGO Kontakttechnik Ges.m.b.H.
Europaring F15 602
Campus 21
2345 Brunn am Gebirge
Phone +43 1 6150780
Fax +43 1 6150775
wago-at@wago.com

Azerbaijan

AZ Technics LTD
Zulfi V. Alizade
Y.Safarov str.33, AZ1025,
Baku
Phone +994 50 210 24 49
Fax +994 12 496 83 34
info@AZtechnics.az

Bangladesh

please contact WAGO India

Belarus

DemsEnergO LLC
Smolyachkova Str. 16, Office 2
220005 Minsk
Phone: +375 17 2102189
Fax: +375 17 2102189
dems@dems.by

ATAVA Techno Ltd.

Ul. Denisovskaya 47, Office 1
220006 Minsk
Phone: +375173881018
atava@atava.by

Belgium

WAGO BeLux nv
Excelsiorlaan 11
1930 Zaventem
Phone +32 2 717 9090
Fax +32 2 717 9099
info-be@wago.com

Bolivia

ISOTEK S.R.L.
Zona Casco Viejo
Calle Isso #578, B/San Roque
Santa Cruz
Phone +591 721 000 27
info@isotek.bo

Bosnia & Herzegovina

please contact WAGO Bulgaria

AM-ELEKTRIK doo
Dzemala Bijedica 160F
71000 Sarajevo
Phone +38762 59 99 54
Fax +38733 92 23 89
info@amelektrik.com
www.am-elektrik.com

Brazil

WAGO Eletroeletrônicos Ltda
Rua Tripoli, 640, Lotamento Multivias II
Jardim Ermida I
Jundiaí - SP
CEP 13212-217
Phone +55 (11) 2923 7200
info.br@wago.com

Bulgaria

WAGO Kontakttechnik GmbH & Co. KG
Representative Office Sofia
Business Center Serdika
2E Akad. Ivan Geshov Blvd.
Building 1, Floor 4, Office 417
1330 Sofia
Phone +359 2 489 46 09/10
Fax +359 2 928 28 50
info-BG@wago.com

Canada

WAGO Canada, Inc.
1550 Yorkton Court - Unit 1
Burlington, ON L7P 5B7
Phone +1-888-9246-221
info.ca@wago.com

Chile

Desimat Chile
Av Puerto Vespuccio 9670
Pudahuel Santiago
Phone +56 2 747 0152
Fax +56 2 747 0153
ventaschile@desimat.cl

China

WAGO Electronic (Tianjin) Co., Ltd.
No.5, Quan Hui Road
Wuqing Development Area
Tianjin 301700
Phone +86 22 5967 7688
Fax +86 22 5961 7668
info-cn@wago.com

Colombia

T.H.L. Ltda.
Cra. 49 B # 91-33
Bogotá
Phone +57 1 621 85 50
Fax +57 1 621 60 28
ventas-thl2@thl.com.co

Croatia

M.B.A. d.o.o.
Frana Supila 5
51211 Matulji
Phone +385 51 275-736
Fax +385 51 275-066
mba@ri.htnet.hr

MICROSTAR d.o.o.

Siget 18 b
10020 Zagreb
Phone +385 1 3647 849
Fax +385 1 3636 662
wago@microstar.hr

Czech Republic

WAGO Elektro spol. sr. o.
Rozvodova 1116/36
143 00 Praha 4 - Modřany
Phone +420 261 090 143
Fax +420 261 090 144
info.cz@wago.com
wago-cz@wago.com

Denmark

WAGO Denmark A/S
Lejrvej 17
3500 Værløse
Phone +45 44 357 777
info.dk@wago.com

Ecuador

ECUAINSETEC CIA LTDA
Yugoslavia N34-110 y Azuay
Quito
Phone +593 2 24 50 475
Fax +593 2 22 51 242
g.castro@ecuainsetec.com.ec

Egypt

KENANA Automation / System Integrator
(Water & Waste Water)
2 Building 10, Block 31
Ibrahim Shehata Street
Nasr City
Cairo, Egypt
Phone +2 01 02899 3434
Fax +2 02 357 3353
mohamed.bahgat@kenanaeg.com

IBN Engineering / Distributor

(Automation Products)
Phone +2 02 3721 4350
Fax +2 02 3722 1709
nasrelwly@ibnengineering.com

Barkouky Electric / System Integrator (Building

Management)
Phone +2 02 2269 1192
Fax +2 02 2269 1193
ahmed@barkouky.com.eg

Misc (Interconnection & Interface Products)

Phone +202 226 80994/7
Fax +202 226 79469
sales@miscegypt.com

Estonia

Eltarko OÜ
Treali tee 2 door 6
Peetri küla
Rae vald
75312 Harjumaa
Phone +372 651 7731
Fax +372 651 7786
andres@eltarko.ee

Finland

WAGO Finland Oy
Perintötie 2 C
01510 Vantaa
Phone +358 9 7744 060
Fax +358 9 7744 0660
tilaus@wago.fi

France

WAGO Contact SAS
Paris Nord 2
83 Rue des Chardonnerets
93290 - Tremblay en France
B.P. 95947 - ROISSY CDG CEDEX
Phone +33 1 4817 2590
Fax +33 1 4863 2520
info-fr@wago.com

Germany

WAGO Kontakttechnik GmbH & Co. KG
Hansastraße 27
32423 Minden
Phone +49 571 887-0
Fax +49 571 887-169
info@wago.com

WAGO Kontakttechnik GmbH & Co. KG

Waldstraße 1
99706 Sondershausen
Phone +49 3632 659-0
Fax +49 3632 659-100
info@wago.com

Great Britain

WAGO Limited
Triton Park, Swift Valley Industrial Estate
RUGBY
Warwickshire, CV21 1SG
Phone +44 1788 568 008
Fax +44 1788 568 050
uksales@wago.com

Greece

PANAGIOTIS SP. DIMOULAS
DIMOULAS AUTOMATIONS
Kritis Str. 26
10439 Athens
Phone +30 210 883 3337
Fax +30 210 883 4436
wago.info@dimoulas.com.gr

Honduras

CILASAS S.A. de C.V.
Barrio Los Andes
7 Calle entre 14 y 15 Ave. N.O.
P.O. Box. 1061
San Pedro Sula
Phone +504 2557 1146/7
Fax +504 2557 1149
ventas@iecilasa.com

Hong Kong

National Concord Eng., Ltd.
Unit A-B, 5/F,
Southeast Industrial Building
611-619 Castle Peak Road
Tsuen Wan, NT.
Phone +852 2429 2611
Fax +852 2429 2164
sales@nce.com.hk

Hungary

WAGO Hungária KFT
Ipári Park, Gyár u. 2
2040 Budapest
Phone +36 23 502-170
Fax +36 23 502-166
info.hu@wago.com

Iceland

S. Gudjonsson ehf.
Smidjuvegur 3
200 Kopavogur
Phone +354 520-4500
Fax +354 520-4501
export@wago.com

India

WAGO Private Limited
C-27, Sector-58, Phase-III
Noida-201 301
Gautam Budh Nagar (U.P)
Phone +91 120 438 8700
Fax +91 120 438 8799
info.india@wago.com

Indonesia

please contact WAGO Singapore

Iraq

please contact WAGO Middle East

Ireland

Drives & Controls
Unit F4, Riverview Business Park
Nangor Road
Dublin 12
Phone +353 1 4604474
Fax +353 1 4604507
info@drivesandcontrols.ie

Israel

Comtel Israel Electronic Solutions Ltd.
Bet Hapaamon
20 Hataas Street
P.O. Box 66
44425 Kefar-Saba
Phone +972 9 76 77 240
Fax +972 9 76 77 243
sales@comPhoneco.il

Italy

WAGO Elettronica SRL a Socio Unico
Via Parini 1
40033 Casalecchio di Reno (BO)
Phone +39 051 6132112
Fax +39 051 6272174
info-ita@wago.com

Japan

WAGO Co. of JAPAN Ltd.
Kinsicho Prime Tower
1-5-7, Kameido, Koto-ku
Tokyo 136-0071
Phone +81 3 5627 2050
Fax +81 3 5627 2055
info-jp@wago.com

Jordan

Oxgen for Engineering Systems Co. L.L.C
PO Box: 2154 Amman
11953 Jordan
Phone +962 79 9 860 869
Fax +962 655 211 89
info@oxgn-grp.com

Kazakhstan

Axima LLP
232/2, Ryskulov avenue
050061 Almaty
Phone +7 727 356 52 91/92/93
Fax +7 727 327 14 92/93
trade1@axima.kz
or@axima.kz

TOO Technik-Trade

ul. i. A. Protosanova, 81
070004 Ust-Kamenogorsk
Phone +7 7232 254 064
Fax +7 7232 253 251
info@technik.kz

Nova Solut LLC (System Integrator)

050042, The Republic Of Kazakhstan,
Almaty city, Toktabayeva 23, #10
Phone +7 777 206 04 76
director@novasolut.kz
tech@novasolut.kz

Korea

WAGO Korea Co., Ltd.
Room 205 AnyangMegaValley,
268, Hagui-ro, Dongan-gu, Anyang-si,
Gyeonggi-do, 14056, South Korea
Phone +82 31 421 9500
info.korea@wago.com

Kosovo

please contact WAGO Bulgaria

Latvia

INSTABALT LATVIA VIA
Vestienas iela 6
Rīga, LV-1035
Phone +371 6790 1188
Fax +371 6790 1180
info@instabalt.lv

Lebanon

Gemayel Trading & Contracting
Rue 55, Antonins Project-Bloc L
P.O. BOX 70-1096
Antelias, Lebanon
Phone +961 3 22 30 29
Fax +961 4 52 10 29
info@gtclb.com

Lithuania

INSTABALT LIT UAB
Savonorių 187
Vilnius, 2053
Phone +370 52 322 295
Fax +370 52 322 247
info@instabalt.lt

Luxembourg

please contact WAGO Belgium

Malaysia

WAGO Representative Office Malaysia
No 806, Block A4, Leisure Commerce Square,
No 9, Jalan PJS 8/9, 46150 Petaling Jaya,
Selangor Darul Ehsan, Malaysia
Phone +60 3 7877 1776
Fax +60 3 7877 2776
kian.guan.tan@wago.com

HPH Materials (M) Sdn Bhd
No. 4, Jalan Nilam 1/6
Suban Hi-Tech Industrial Park
40000 Shah Alam
Selangor, D.E. Malaysia
Phone +60 3 5638 2213
Fax +60 3 5638 8213
info@hphmaterials.com

Macedonia

please contact WAGO Bulgaria

Kompjuner Inzenering
Vladimir Komarov 1A-3/9
1000 Skopje
Phone +389 2 521 12 00

Maledives

please contact WAGO India

Mexico

WAGO SA de CV
Carretera estatal 431 Km. 2+200
Lote 99 Módulo 6
Parque Industrial Tecnológico Innovsciön
Querétaro
El Marqués, Qro. 76246
Phone +52 442 221 5946
Fax +52 442 221 5063
info.mx@wago.com

Moldova

Smart Delight SRL
Bulgara Str. 9/6
2001 Chisinau
Moldau
Phone +373 (373) 69 10 22 01
alexandres@starnet.md

Morocco

Automatisme & Connection Maroc
23, Rue Bourred
2ème étage, appt4
Roche Noire
20300 Casablanca
Phone +212 522 24 21 72/73
Fax +212 522 24 21 75
info-fr@wago.com

Nepal

please contact WAGO India

Netherlands

WAGO Nederland B.V.
Laan van de Ram 19
7234 BW APELDOORN
Phone +31 55 36 83 500
Fax +31 55 36 83 599
info-nl@wago.com

New Zealand

please contact WAGO Australia

NHP NZ
7 Lockhart Place
Mt Wellington
Phone +64 9 2761967
Fax +64 9 2761992
export@wago.com

Nigeria

GIL Automations Ltd.
Daily Times Complex
2 Lateef Jakande Rd., Agidingbi
100271 Ikeja, Lagos State
Phone +234 17132672335
sales@gilautomation.com

Norway

WAGO Norge AS
Jerkoveien 20
1067 Oslo
Phone +47 22 30 94 50
Fax +47 22 30 94 51
info.no@wago.com

Oman

please contact WAGO Middle East

Pakistan

FuziLogiX Automation & Control
Suit No. 14, 5th Floor, Shan Arcade
New Garden Town, Lahore
Phone +92 42 594 1503 - 4
Fax +92 42 585 1431
info@fuzilogix.com

Pakistan

S.A. Hamid & Co.
7 Brandreth Road
Lahore, 54000
Phone +92 42 376 500 99
Fax +92 42 376 513 91
sales@sahamid.com

Paraguay

AESA
Av. Madame Lynch
c/Antolin Irala
2309 Asunción
Phone +59 521674524
info@aesa.com.py

Peru

Manufacturas Eléctricas S.A.
Av O.R. Benavides 1215
15000 Lima
Phone +511 6196200
Fax +511 6196247
ventas@manelsa.com.pe

Philippines

please contact WAGO Singapore

Poland

WAGO ELWAG sp. z o. o.
ul. Piękna 58 a
50-506 Wrocław
Phone +48 71 3602970
Fax +48 71 3602999
wago.elwag@wago.com

Portugal

MORGADO & CA. LDA - SEDE
Estrada Exterior da
Circunvalação 3558/3560
Apartado 1057
4435 Rio Tinto
Phone +351 22 9770600
Fax +351 22 9770699
geral@morgadocl.pt

Quatar

GEBD - Gulf European Business
Development - Company W.L.L.)
PO Box: 20 000
Doha, Quatar
Phone +974 5591 5682
info@gebdc.com

Romania

WAGO Kontakttechnik GmbH & Co. KG
Representative Office Romania
Sos. Pipera-Tunari nr. 1/1
building 1, 2nd floor
077190 Voluntari, Ilfov
Phone +40-(0)31 421 85 68
info-RO@wago.com

VDR & Servicii srl

Str. Valeriu Braniște, nr. 60, ap.1,
sector 3
Phone +40 21 322 5074/76
Fax +40 21 322 5075
office@componente-automatizari.ro

Russia

OOO WAGO Contact Rus
Ilmskaya stret 5, bldg. 2
127576 Moscow
Phone +7 495 223-4747
info.ru@wago.com
www.wago.ru

OOO Prosoft

ul. Profsoznaya, 108
117437 Moscow
Phone +7 495 2340636
Fax +7 495 2340640
info@prosoft.ru

Saudi Arabia

Saudi Electronic Trading
P.O. Box 60712
Riyadh 11555
Phone +966 11 2063 377
Fax +966 11 4633 297
info@setra.com.sa

Serbia

please contact WAGO Bulgaria

Mehatronik Sistem d.o.o.
Bul. Oslobođenja 30
32000 Cacak
Phone +381 (0)32 310 088
Fax +381 (0)32 371 571
Mobil +381 (0)64 877 22 02
office@mehatronik.com

Sigma Controls Engineering doo
Jovana Skerlica 22
18000 Nis
Mobil +381 (0)63 403 104
wago@sce.rs
www.sce.rs

Singapore

WAGO Electronic Pte Ltd
138 Joo Seng Road #06-01
Singapore 368361
Phone +65 62866776
Fax +65 62842425
info-sing@wago.com
www.wago.sg

Slovakia

Proelektro spol. s r.o.
Na barine 22
841 03 Bratislava - Lamač
Phone +421 2 4569 2503
info@wago.sk

Slovenia

IC elektronika d.o.o.
Vodovodna cesta 100
1000 Ljubljana
Phone: +386 1568 01 26
Fax: +386 1568 91 07
info@ic-elect.si

South Africa

Shorrock Automation CC
Nellmapius drive
5 Regency Drive, Route 21 Corp. Park
0051 Centurion
Phone +27 12 4500300
Fax +27 12 4500322
sales@shorrock.co.za

Spain

DICOMAT S.L.
Avda. de la Industria, 36
Apartado Correos, 1.178
28108-Alcobendas (Madrid)
Phone +34 91 662 1362
Fax +34 91 661 0089
info@dicomat-asetyc.com

Sri Lanka

please contact WAGO India

Sweden

WAGO Sverige AB
Box 11127, 161 11 BROMMA
Besöksadress: Adolfsbergsv. 31
Phone +46 858410680
info.se@wago.com

Switzerland

WAGO CONTACT SA
Rte. de l'Industrie 19
Case Postale 168
1564 Domdidier
Phone +41/26 676 75 00
Fax +41/26 676 75 01
info.switzerland@wago.com

Syria

Zahabi Co.
8/5 Shouhadaa St., P.O. Box 8262
Aleppo
Phone +963 21 21 22 235 / 6
Fax +963 21 21 22 23 7
info.uae@wago.com

Taiwan R.O.C.

WAGO Contact, Ltd.
5F., No.168, Jiankang Rd
Zhonghe City
Taipei County 23585, Taiwan
Phone +886 2 2225 0123
Fax +886 2 2225 1511
info.taiwan@wago.com

Thailand

WAGO Representative Office Thailand
4th Floor, KS Building
213/6-8 Rachada-Phisek Road
Dingdaeng, Bangkok 10400
Phone +66 2 6935611
Fax +66 2 6935612
warongkon.khankham@wago.com

US Power Distribution Co., Ltd.

4th Floor, KS Building
213/6-8 Rachada-Phisek Road
Dingdaeng, Bangkok 10400
Phone +66 2 2763040
Fax +66 2 2763049
uspwer2014@gmail.com

Itthirit Technology Co., Ltd.

Vision Business Park 2 Floor 4
Soi Raminthra 55/8, Watcharapon Road
Tharaeng, Bangkok District
Bangkok Thailand 10220
Phone +66 2 347 0780
Fax +66 2 347 0772
sales@itthirittechnology.com

Tunisia

please contact WAGO France

Turkey

WAGO Elektronik Sanayi ve Ticaret Ltd. Şti.
Yükarı Dudullu Mahallesi Bayraktar Bulvarı
Cad. Hattat Sok. No. 10
34775 Ümraniye - İstanbul
Phone +90 216 472 1133
Fax +90 216 472 9910
info.tr@wago.com

Ukraine

NPP Logicon
Predslavinskaya street, 39, Office 303
03150 Kiev
Phone +380 44 5228019
Fax +380 44 2611803
info@logicon.ua

Micropribor Ltd.

4, Krzhizhanovskiy Str.
03142 Kiev
Phone +380 44 392 93 86
Fax +380 44 392 93 87
sales@micropribor.kiev.ua

United Arab Emirates (UAE)

WAGO Middle East (FZC)
SAIF Zone, Q4-282
P.O. Box 120665
Sharjah, UAE
Phone +971 6 5579920
Fax +971 6 5579921
info.uae@wago.com

Uruguay

Fivisa Electricidad
Avda. Uruguay 1274
11100 Montevideo
Phone +59 829 020 808
Fax +59 829 021 230
info@fivisa.com.uy

USA

WAGO CORPORATION
N120 W19129 Freistadt Road
Germantown, WI 53022
Phone +1 262 255 6222
Fax +1 262 255 3232
Toll-Free: 1-800 DIN Rail (346-7245)
info.us@wago.com

Venezuela

PETROBORNAS, C.A.
C.C. PLAZA AEROPUERTO - PISO 1 - LOCAL
P1-B-03
(8015) UNARE - PUERTO ORDAZ -
ESTADO BOLIVAR
REPÚBLICA BOLIVARIANA DE
VENEZUELA
Phone +58 286 951 3382
Fax +58 286 951 3382
info@petrobornas.com

Vietnam

please contact WAGO Germany (Minden)

Version: 02/2019

Current adresses at www.wago.com

Notes

A large grid of graph paper for taking notes. The grid consists of 30 columns and 35 rows of small squares, providing ample space for writing or drawing.

Notes

