

PSF 5.0

Product Short Form

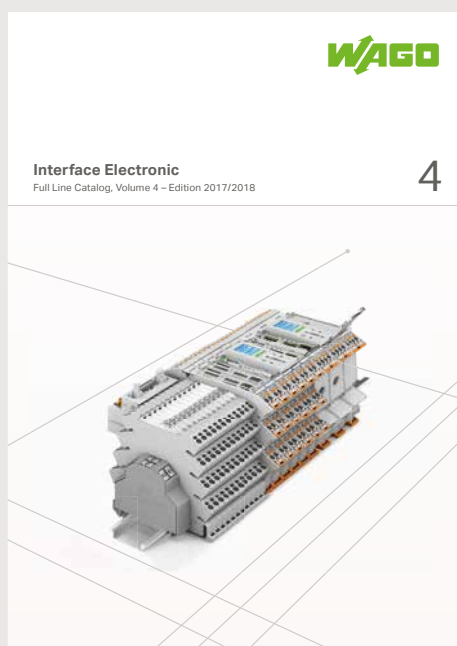

WAGO Full Line Catalogs

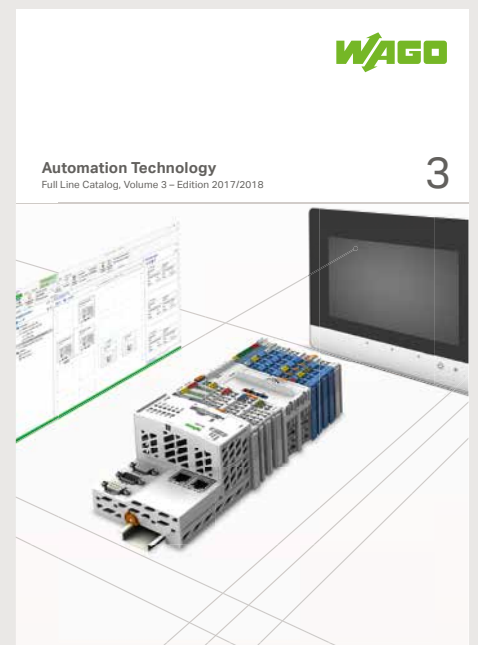

Volume 1, Rail-Mount Terminal Block Systems

- Rail-Mount Terminal Blocks
- Rail-Mount Terminal Blocks with Pluggable Connector (X-COM®-SYSTEM)
- Patchboard Systems
- Terminal Strips
- PUSH WIRE® Connectors for Junction Boxes
- Lighting Connectors
- Shield Connecting System



Volume 2, PCB Terminal Blocks and Connectors

- PCB Terminal Blocks
- SMD PCB Terminal Blocks
- *MULTI CONNECTION SYSTEM (MCS)*
- Pluggable PCB Terminal Blocks
- Feedthrough Terminal Blocks
- Specialty Connectors
- Empty Housings



Volume 3, Automation Technology

- Software
- Operating & Monitoring
- Controllers
- Modular I/O-SYSTEM, IP20/IP67
- Industrial Switches
- Radio Technology, *TO-PASS®* Telecontrol Technology
- IP67 Sensor/Actuator Boxes, IP67 Cables and Connectors



Volume 4, Interface Electronic

- Relay and Optocoupler Modules
- *JUMPFLEX®* Signal Conditioners and Isolation Amplifiers
- Current and Energy Measurement Technology
- *EPSITRON®* Power Supply System
- Interface Modules and System Wiring
- Overvoltage Protection
- Empty Housings



Volume 5, *WINSTA®* – The Pluggable Connection System

- Pluggable Connectors
- Snap-In Device Connectors
- Pluggable PCB Connectors
- Distribution Connectors
- Cable Assemblies
- Flat Cable Systems
- Distribution Boxes











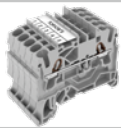

Volume 6, Marking

- Terminal Block Marking
- Cable and Conductor Marking
- Device Marking
- Printer
- Software
- Marker Carriers

PSF 5.0

Page

	Rail-Mounted Terminal Block Systems Through Terminal Blocks, Multilevel Terminal Blocks, Ground Terminal Blocks, Ex Terminal Blocks, High-Current Terminal Blocks, Fuse Terminal Blocks, Disconnect Terminal Blocks, Diode Terminal Blocks, Sensor/Actuator Terminal Blocks, X-COM®-SYSTEM, Miniature Terminal Blocks	22	1
	Device Terminal Blocks and Installation Connectors Chassis-Mount Terminal Strips, Lighting Connectors, LINECT®, PUSH WIRE® Connectors for Junction Boxes, Transformer Terminal Blocks	96	2
	Pluggable Connectors <i>picoMAX</i> ®, <i>MULTI CONNECTION SYSTEM (MCS)</i> : MICRO, MINI, MINI HD, MIDI, MIDI Classic, MAXI	110	3
	PCB Terminal Blocks Terminal Strips, Modular Terminal Blocks, Multilevel Terminal Strips, SMD Terminal Blocks, Terminal Blocks	126	4
	WINSTA® Pluggable Connection System Pluggable Connectors, Distribution Connectors, Cable Assemblies, Distribution Boxes	134	5
	Automation Technology <i>e!COCKPIT</i> Engineering Software, Fieldbus Couplers, Programmable Fieldbus Controllers, Input and Output Modules, <i>PERSPECTO</i> ®, <i>e!DISPLAY</i> ®, Sensor/Actuator Boxes, Industrial Switches, Shield Connecting System	142	6
	Power Supplies <i>EPSITRON</i> ® Power Supplies, Electronic Circuit Breakers (ECBs), Uninterruptible Power Supply (UPS), Buffer and Redundancy Modules	186	7
	Interface Electronic <i>JUMPFLEX</i> ® Signal Conditioners and Isolation Amplifiers, Relay Modules, Optocoupler Modules, Relay Sockets, Function Modules	200	8
	Current and Energy Measurement Technology Current Transformers, Rogowski Coils, Current Sensors, Voltage Taps, Rogowski Signal Conditioners	224	9
	Accessories for Automation Technology and Interface Electronic Interface Cables and Modules, Empty Housings, Empty Component Plug Housings, DIN-Rail-Mount PCB Carriers	230	10
	Marking Systems, Tools, Measurement Devices and Mounting Accessories	238	11
	Technical Section	264	12
	Index and Addresses	270	13

More than 50 Years of Innovation



1951

The First
WAGO Spring Clamp
Terminal Block

Since its establishment in 1951, WAGO has pioneered multiple innovative connection systems for both electrical and electronic engineering applications. The idea for a screwless termination system was born in 1951; the first terminal blocks with spring clamp termination technology were presented at the Hanover Fair the same year.



1974

WAGO PUSH WIRE®
Connector for Junction
Boxes

Precisely designed and manufactured, spring clamp terminal blocks not only guarantee a faster and easier connection, but also offer greater safety because the contact quality is largely independent of operator skill.



1977

CAGE CLAMP® Rail-
Mounted Terminal Blocks

Now, WAGO is meeting virtually all of the industry's needs as both the leader in Spring Pressure Connection Technology and a pioneer in automation technology. In 1977, the success story of the CAGE CLAMP® began with "vibration-proof, fast and maintenance-free connections." Safe operation for countless devices, systems and installation depends on the unconditional reliability of our products.

1985

Pluggable Electronic Modules
for Rail-Mounted Terminal Blocks



1998

POWER
CAGE CLAMP®



2003

TOPIJOB® S
Rail-Mounted Terminal
Blocks

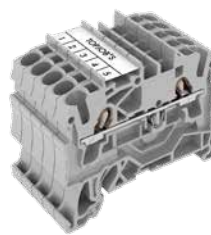

2005

WAGO SPEEDWAY 767,
Modular I/O-SYSTEM, IP67



1995

WAGO-I/O-SYSTEM, 750/753
Series Modular I/O-System,
IP20

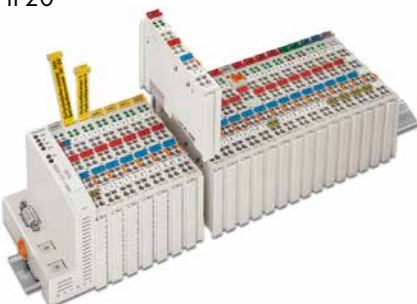

2001

WINSTA® -
The Pluggable Connection
System



2004

CLASSIC Splicing
Connectors for All
Conductor Types,
222 Series



2006

WAGO JUMPFLEX® -
Signal Conditioners and
Pluggable Relay Modules



Recognized and Approved Worldwide



2008

TO-PASS® - Scalable
Telecontrol Technology



2010

PERSPECTO® -
Touch and Control Panels

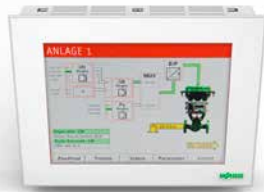

2014

COMPACT Splicing
Connectors for All
Conductor Types,
221 Series



2015

PFC200 -
Controllers



2009

X-COM®S-SYSTEM



2010

PUSH WIRE®
Connectors for
Junction Boxes,
2273 Series



2014

Shield Clamping
Saddles



2015

e!COCKPIT Software
Integrated Engineering



From Pioneer to Leader

When the first screwless terminal blocks debuted at the Hanover Fair in 1951, they represented a significant advancement in manufacturing. At the time, manufacturing terminal blocks was not possible because the carbon steel available then did not meet the high quality requirements.

However, WAGO was quite active in the years leading up to the 1977 debut of the first series of CAGE CLAMP®-equipped rail-mounted terminal blocks from 28-6 AWG (0.08-16 mm²).

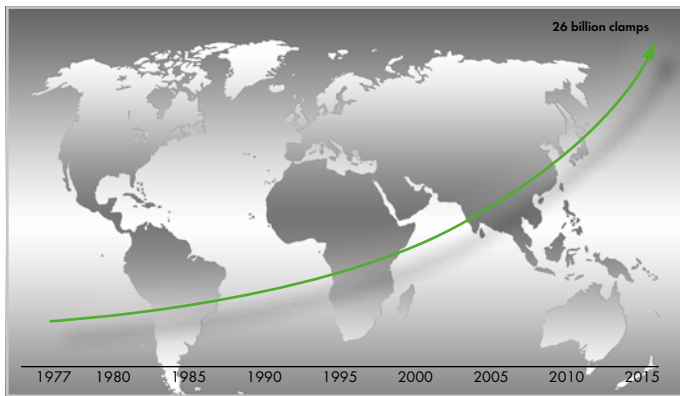

Number of CAGE CLAMP® springs produced to date

With numerous developments – from the Suprafix banana plug product family up to the first range of rail-mounted terminal blocks for conductors up to 6 AWG (16 mm²) – WAGO has firmly established itself as an innovator.

With this reputation and the desire for “vibration-proof, fast and maintenance-free” connections, CAGE CLAMP® quickly outperformed all previous connection technologies to become a worldwide industrial standard.

Today, CAGE CLAMP® technology has several imitators, yet it remains unmatched. And WAGO continues to set new standards with further developments, such as CAGE CLAMP® Compact (1996) for ultra-compact applications and the WAGO POWER CAGE CLAMP (1998) for a rated cross-section up to 350 kcmil (185 mm²). Figures speak for themselves: More than 26 billion CAGE CLAMP® springs have been sold worldwide, and every day, millions of clamps are added to that number.

In 1951, WAGO was founded in Minden, Germany. Now, the WAGO Group consists of 32 companies with more than 6,700 employees, worldwide operations and global sales of 706 million euros (2015).

The first factory was located in Minden, Germany, which is also our headquarters. As part of WAGO’s global expansion, additional factories have been built: 1977 in Domdidier (Switzerland), 1979 in Milwaukee (USA), 1995 in Sondershausen (Germany) and Delhi (India), 1997 in Tianjin (China) and Wroclaw (Poland).

Products manufactured locally for domestic and foreign markets create the starting point for localized distribution networks that cover WAGO’s complete product portfolio. Such organization enables WAGO subsidiaries and sales offices to develop and deliver custom-designed products that comply with local regulations and meet local demand. More than half of WAGO’s global staff of 6,700 is employed outside of Germany.

WAGO Worldwide



WAGO Minden, Germany – Global Headquarters



WAGO Sondershausen, Germany



WAGO Switzerland



WAGO Poland



WAGO India



WAGO USA



WAGO China

WAGO – At Home in the World

WAGO is a group of companies that operates globally with subsidiaries or agencies on all continents and production facilities in Germany (Minden, Westfalia and Sondershausen, Thuringia); Switzerland (Domdidi-

er, Fribourg); Poland (Wroclaw); China (Tianjin); India (Noida, Delhi); USA (Germantown) and Japan (Koto-Ku, Tokio).

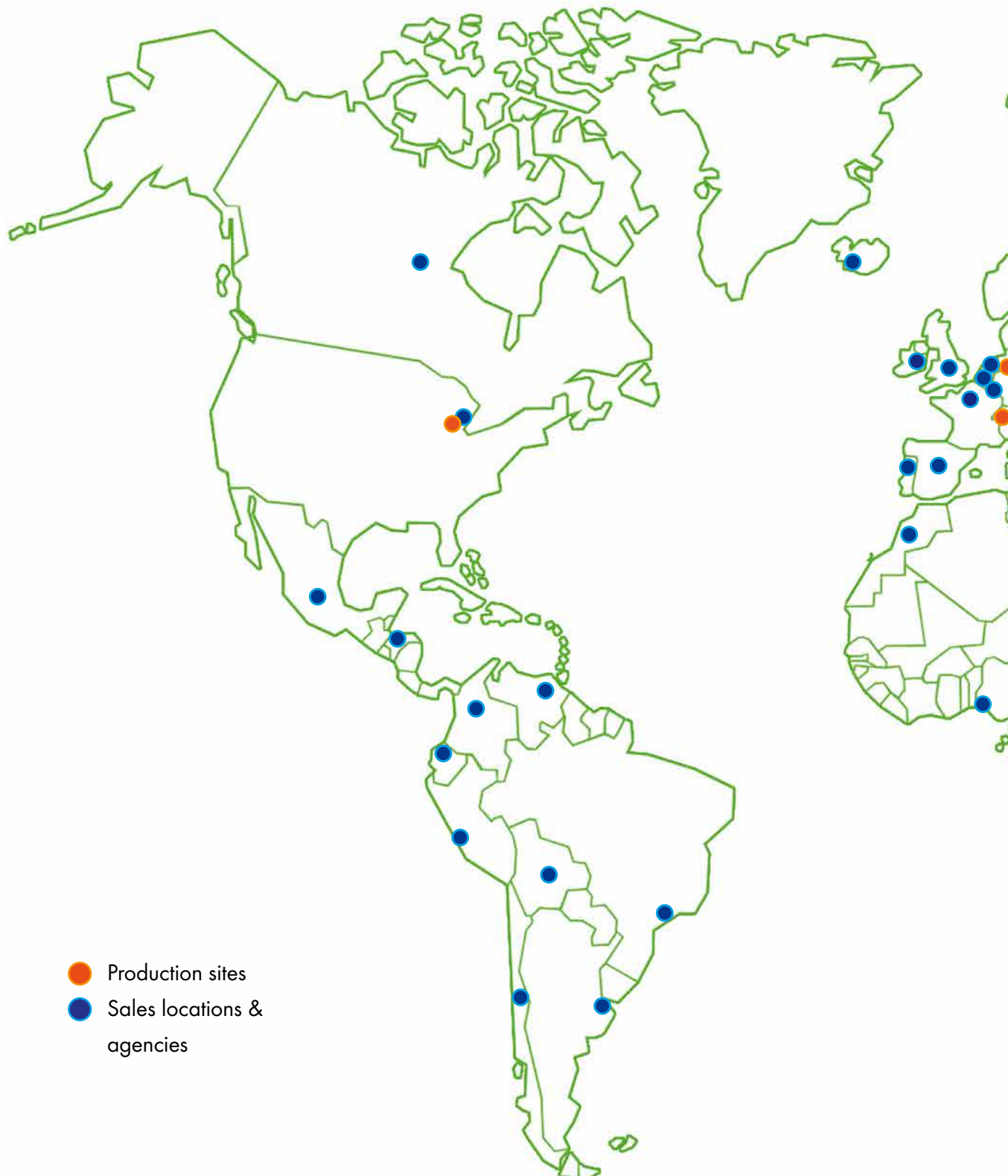

International Success Requires International Presence

Our presence in local markets enables us to provide service tailored to our individual customers, while keeping a finger on the pulse of our valued suppliers.

This proximity allows us to develop and deliver products and solutions that comply with local codes and regulations. That is what we consider being close to our customers.



WAGO Product Range: Electrical Interconnections

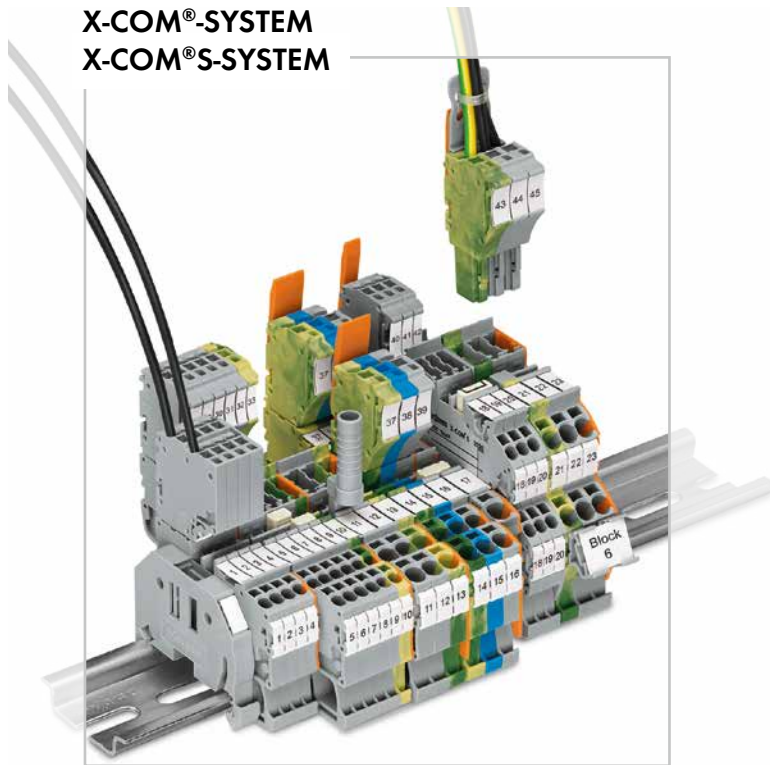

Installation Connectors

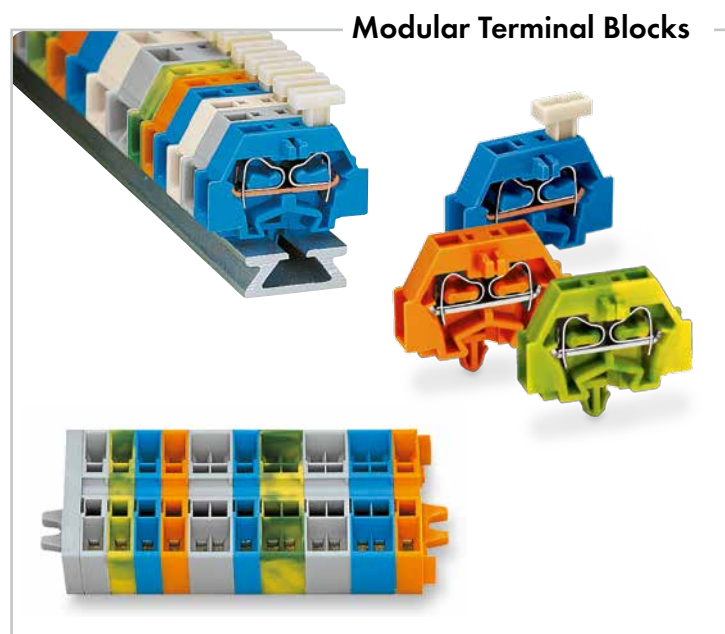
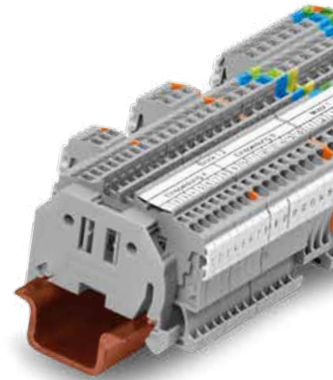

PCB Terminal Blocks



Rail-Mounted Terminal Block Systems

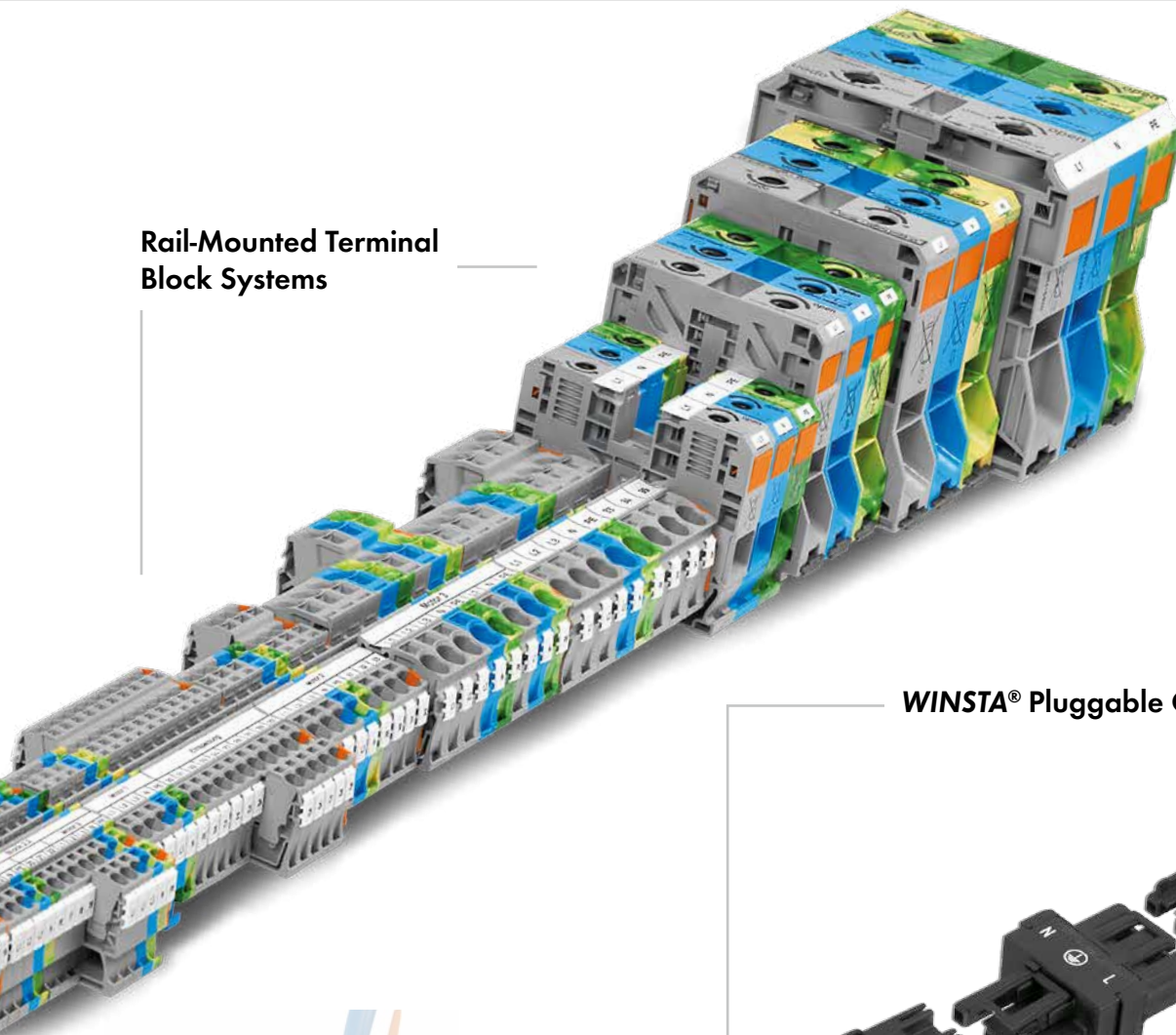

WINSTA® Pluggable Connection System



picoMAX®

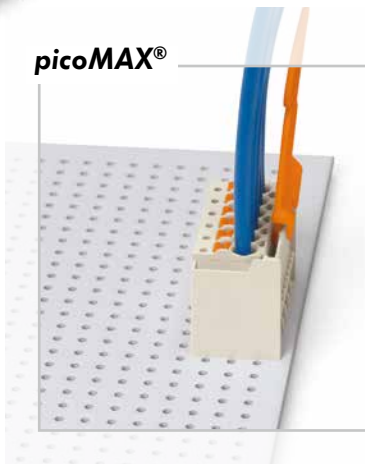

Patchboard Systems

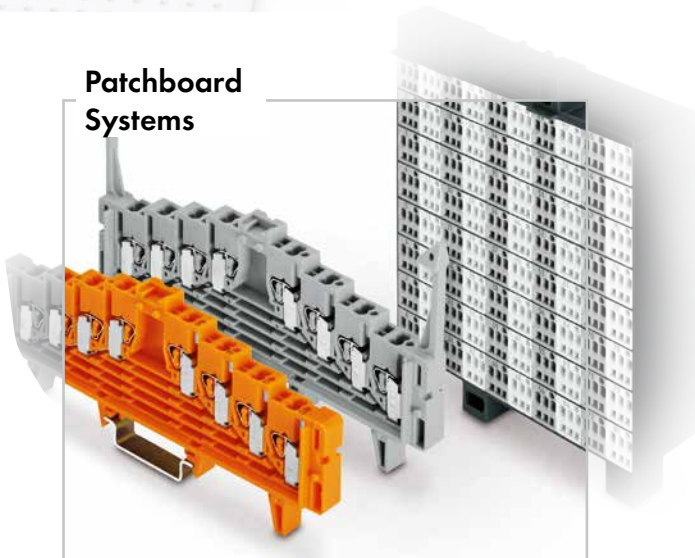

Pluggable Connectors

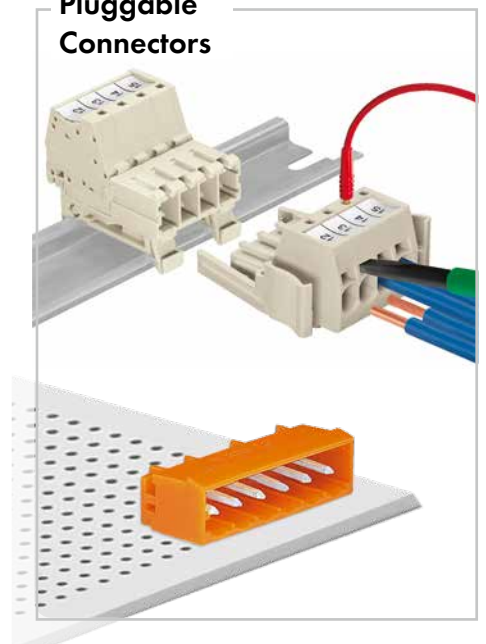

WAGO Product Range: Automation

e!DISPLAY



Controllers



EPSITRON® – Advanced Power Supply System



WAGO I/O-Systems



Software and Apps



Interface Modules

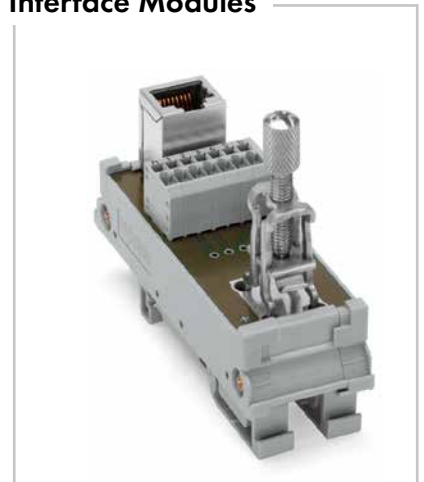

JUMPFLEX® Signal Conditioners



Overvoltage Protection

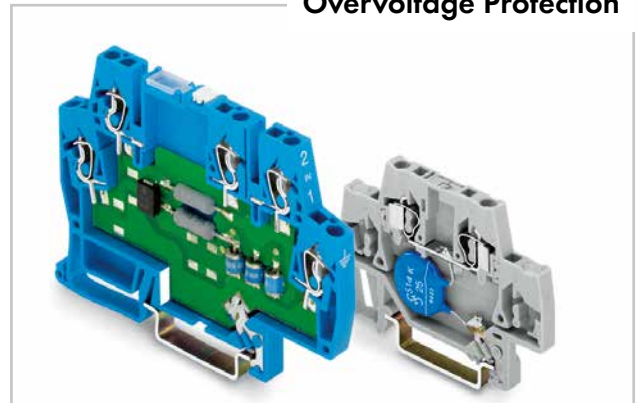

Relay Modules and Sockets

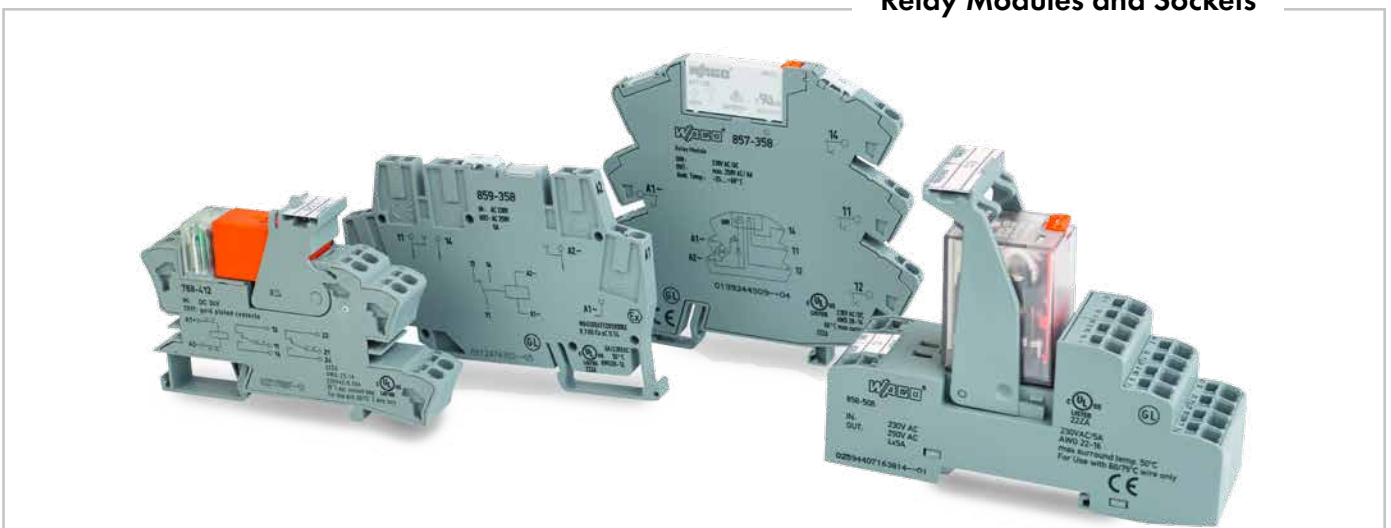

A Wide Variety of Applications

BUILDING AUTOMATION



Building installation and automation

POWER AND PROCESS TECHNOLOGY



Energy, food, water, chemical, petrochemical and metal industries

INDUSTRY



Plant automation and traffic engineering

WAGO products support a wide range of industries. Our components and systems are trusted worldwide in industrial, automotive, process engineering, building technology and many other sophisticated applications. In every industry and every country, we focus on the following objectives:

- Implementing innovative solutions
- Creating a compact design
- Saving energy
- Making equipment safer
- Reacting to requirements quickly and flexibly
- Minimizing installation, maintenance costs and downtime
- Ensuring reliable operation under extreme conditions
- Guaranteeing high availability and technical safety
- Accommodating individual customer requirements

Operating WAGO Connection Technologies

Please follow the applicable product-specific termination instructions.

PUSH-IN CAGE CLAMP®

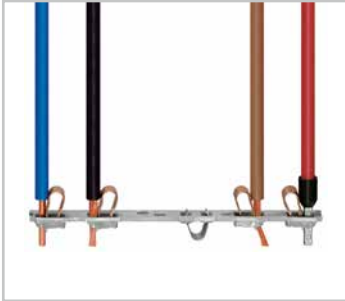

Push-in CAGE CLAMP® terminates the following copper conductors: solid



stranded



fine-stranded, also with tinned single strands



fine-stranded, tip-bonded



fine-stranded, with ferrule (gastight crimped)



fine-stranded, with pin terminal (gastight crimped)

The universal connection with an additional advantage: Push-in connection

Terminate solid and stranded, as well as ferruled conductors, by simply pushing them in - no tools required.

Termination for all conductor types:

- Open clamping unit
- Insert the conductor
- Release clamp

CAGE CLAMP®

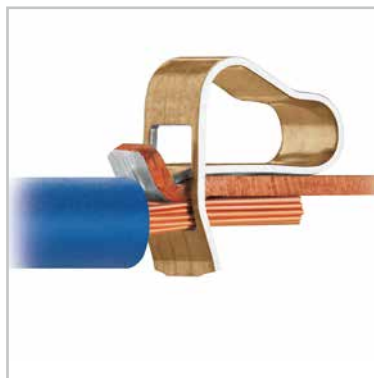

CAGE CLAMP® terminates the following copper conductors: solid



stranded



fine-stranded, also with tinned single strands



fine-stranded, tip-bonded



fine-stranded, with ferrule* (gastight crimped)



fine-stranded, with pin terminal (gastight crimped)

The universal connection for solid, stranded and fine-stranded conductors

Termination:

- Open clamping unit
- Insert the conductor
- Release clamp

*With ferruled, fine-stranded conductors, it is necessary to use a terminal block one size larger than the conductor's nominal cross-section.

Operating WAGO Connection Technologies

Please follow the applicable product-specific termination instructions.

POWER CAGE CLAMP



POWER CAGE CLAMP
terminates the following
copper conductors:
solid



stranded



fine-stranded,
also with tinned
single strands



fine-stranded,
with ferrule
(gastight crimped)

The universal connection for conductors larger than 2 AWG (35 mm²)

Termination:

- Open clamp by turning an Allen wrench counter-clockwise
- Press the integrated latch to open clamping unit for hands-free wiring
- Insert the conductor
- A small counter-clockwise rotation closes the clamp, securing conductor

PUSH WIRE®

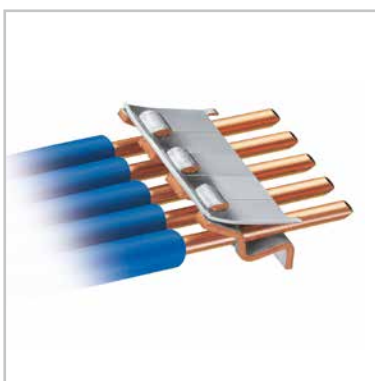
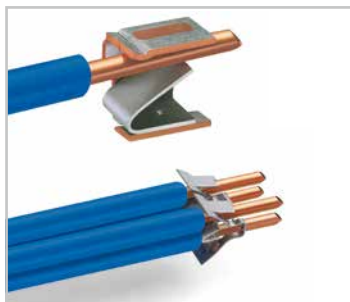

PUSH WIRE®
terminates the following
copper conductors:
solid



stranded

PUSH WIRE® connection for solid and stranded conductors (depending on the model used)

Termination:

Tool-free, twist-free terminations for solid and rigid stranded conductors – simply push into the unit.

WAGO Connection Technology Benefits

Simple, Easy-to-Use Design

Front-entry wiring:

PUSH-IN CAGE CLAMP®

Push-in CAGE CLAMP®
connection



Push-in CAGE CLAMP® terminates both solid and ferruled conductors by simply pushing them in.

Side-entry wiring:

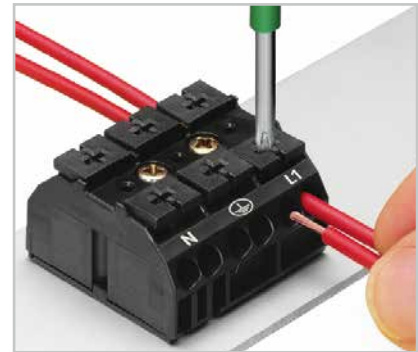

CAGE CLAMP®

CAGE CLAMP®
connection

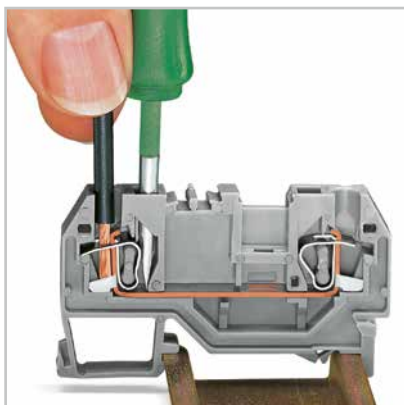

CAGE CLAMP®
connection

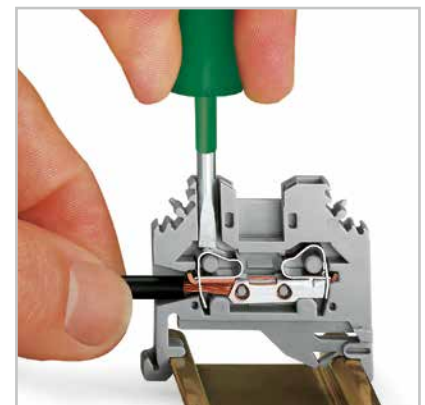

One Conductor per Clamping Unit

A number of VDE directives mandate or recommend that only one conductor should or must be connected per clamping unit (e.g., DIN VDE 0611, Part 4, 02.91, Section 3.1.9). WAGO complies with this safety requirement, as expressed in the corresponding directives.

Technical and economical benefits for the users:

- Each conductor is clamped independently.
- Any conductor size combination per potential can be safely connected.
- Where re-wiring is required, only the conductor to be changed is removed from the clamping point, all other conductors remain safely clamped.
- The arrangement of more than two clamping units on one current bar permits potential multiplication, without jumpers or additional terminal blocks.

CAGE CLAMP® and Push-in CAGE CLAMP® terminate all copper conductors from 28–2 AWG (0.08–35mm²) (350 kcmil/185 mm²), or from 22–4 AWG (0.25–25 mm²). Splice protection is not required, but possible.

The conductor is pressed against the current bar in the **predefined contact area**, without damage. The clamping force adjusts automatically to the conductor size. The clamp dynamically compensates for changes/movement of the conductor to eliminate the risk of a loose connection.

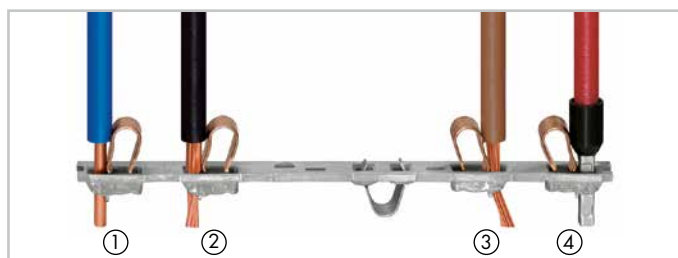

Push-in CAGE CLAMP® terminates one conductor per clamping unit.

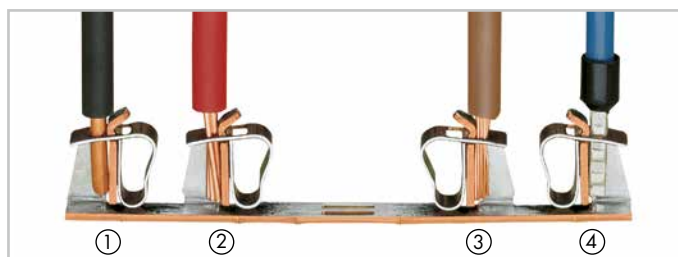

CAGE CLAMP® terminates one conductor per clamping unit.

- ① solid
- ② stranded
- ③ fine-stranded
- ④ fine-stranded, with ferrule (gastight crimped)

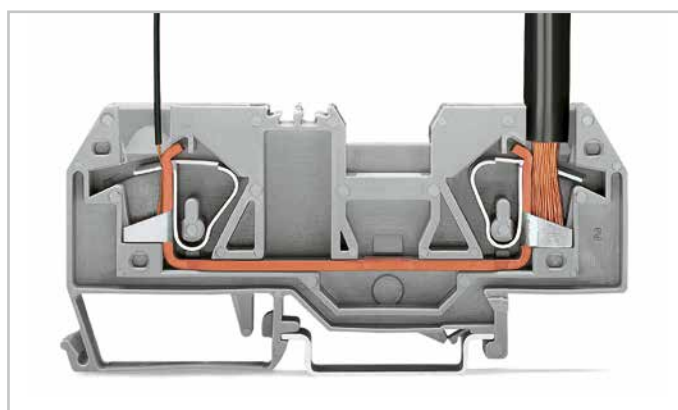

An unlikely connection demonstrates this capability: 24 AWG (0.2 mm²) conductor (left) and 6 AWG (16 mm²) conductor (right) in a 6 AWG (16 mm²) terminal block.

WAGO Connection Technology Benefits

Vibration- and Shock-Proof – Maintenance-Free

The **vibration-proof properties** of CAGE CLAMP® connections have been tested and successfully validated in a vibration test to IEC/EN 60068-2-6. In this test, a frequency band up to 2000 Hz, at different accelerations up to 20g and different amplitudes up to 20 mm, is passed continuously in three axes. Additionally, international authorities have placed extremely demanding requirements on electrical installations. Railway authorities tested for electrical installations in rolling stock (IEC/EN 61373); multiple marine agencies (e.g., GL, LR and DNV) have declared that CAGE CLAMP® meets their lofty approval standards.

In the **Impact Test** (IEC/EN 60068-2-27) for railway applications (IEC/EN 61373), test specimens are exposed to instant shock stresses, instead of permanent vibrations. Stresses up to 100g on the x-, y- and z-axis were easily passed.

Maintenance-free operation **results from excellent long-term consistency of the electrical and mechanical properties of the clamping connection – or more precisely, the clamping unit**. The Voltage Drop Test evaluates clamping unit quality under stresses such as vibrations, temperature changes and corrosive influences, in order to verify that the contact point is gas-tight. The long-term consistency of CAGE CLAMP® technology has been demonstrated both through laboratory testing by international approval agencies and from worldwide applications.

The resulting maintenance-free operation reduces service costs, leading to greater equipment availability and reliability.

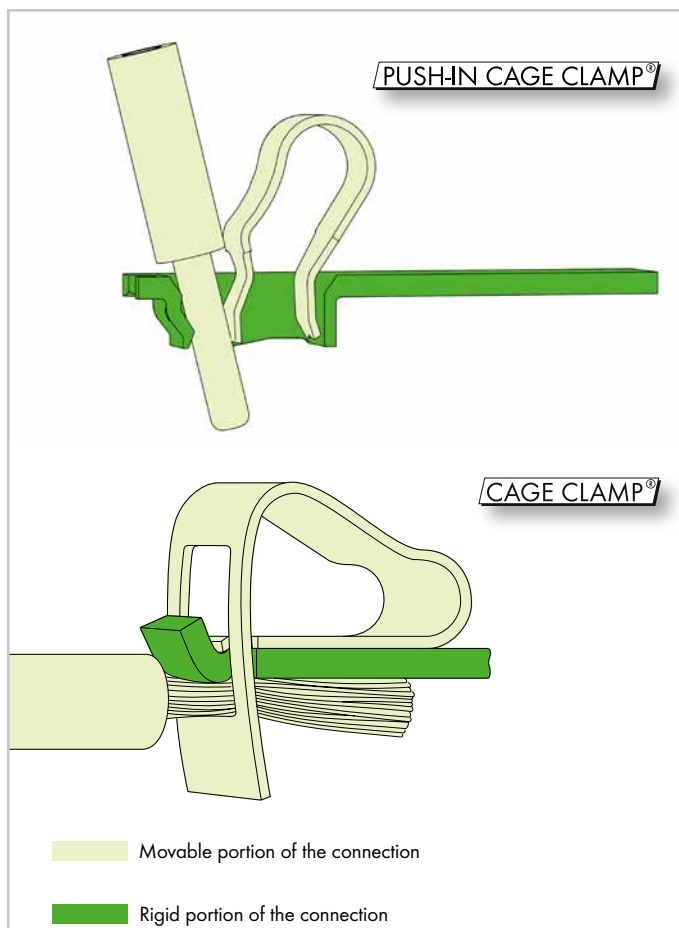

Vibration test: WAGO-I/O-SYSTEM

High-Current Carrying Capacity



Unrealistic test of a CAGE CLAMP® rail-mounted terminal block, 12 AWG (4 mm²): **Increase of current without time limit**; In such an extreme test – normally, fuse devices would have interrupted the current – **the electrical connection is undamaged.**

In the **Short-Time Withstand Current Test** (e.g., per IEC/EN 60947-7-1), through rail-mounted terminal blocks shall be capable of withstanding for one second the **rated short-time withstand current which corresponds to 120 A/mm² of its rated cross-section**. In the case of a **WAGO 285 Series** 185 mm² (350 kcmil) High-Current Terminal Block, this translates to 22,200 A!

Ground conductor terminal blocks are submitted to the “120 A per mm²” test for 3x one second.

The pass criterion for the test is the voltage drop (limit value and constancy). CAGE CLAMP® and Push-in CAGE CLAMP® connections passed this test without damage or reduced functionality.

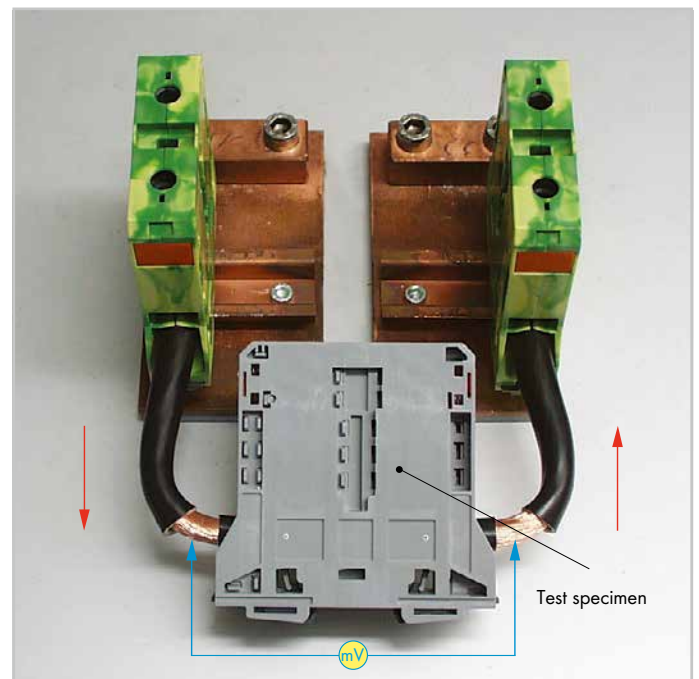

Test arrangement: “Short-Time Current Withstand Test”

WAGO Connection Technology Benefits

Gastight Clamping Units – Measurable Contact Quality

Climatic chambers simulate standard atmospheres that could impact the long-term constancy of clamping units. All WAGO products meet requirements for the following climatic tests:

- Temperature Cycling Test per IEC/EN 60947-7-1, IEC/EN 60998-2-2
- Industrial Atmospheres per EN ISO 6988, IEC/EN 60068-2-42, IEC/EN 60068-2-60
- Salt Spray Test per IEC/EN 60068-2-11; Marine Applications GL, LR, DNV
- Quick Change of Temperature per IEC/EN 60068-2-14
- Damp Heat, Cyclic (12 + 12 Hour Cycle) per IEC/EN 60068-2-30; Marine Applications GL, LR, DNV

Long-term consistency for the low contact resistance of both CAGE CLAMP® and Push-in CAGE CLAMP® results from **gas-tight** clamping units. The spring clamp (acid- and saltwater-proof CrNi spring steel) presses the connected conductor against the current bar (electrolyte copper with lead-free, pure tin coating) within a defined contact zone. The conductor is embedded into the soft tin layer with high contact pressure, securing it against corrosive infiltration.



Contact pressure

$$P \left[\frac{\text{N}}{\text{mm}^2} \right] = \frac{\text{Force } F \text{ [N]}}{\text{Area } A \text{ [mm}^2 \text{]}}$$

Numerical example

$$\left[\frac{700 \text{ N}}{4 \text{ mm}^2} \right] = \left[\frac{70 \text{ N}}{0.4 \text{ mm}^2} \right]$$

Screw Spring

The contact pressure exerted by CAGE CLAMP® connections is similar to screw connections.



To best evaluate the quality of a clamping point, WAGO uses the following test procedures:

The **Voltage Drop Test** evaluates clamping unit quality under stresses such as vibrations, temperature changes and corrosive influences.

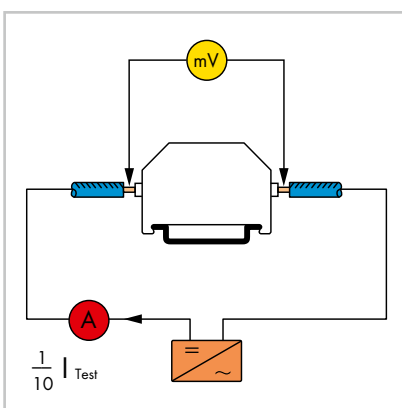

Test arrangement: "Voltage Drop Test"

The **Temperature-Rise Test** examines the clamping unit, including the surrounding insulation, at rated current, over-current and short circuit current levels.

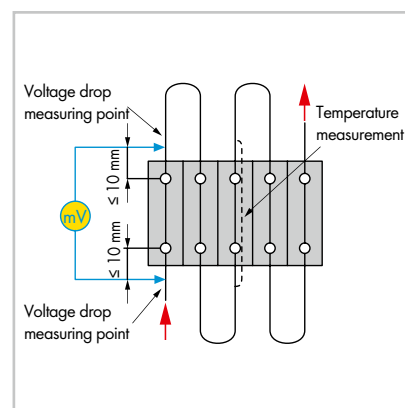

Test arrangement: "Temperature-Rise Test"

Electromagnetic Compatibility (EMC)

State-of-the-art testing equipment in our laboratory enables us to conduct the most stringent electrical, mechanical and climatic tests. In addition, our electromagnetic compatibility chamber is dedicated to testing our automation components for compliance with electromagnetic safety regulations.

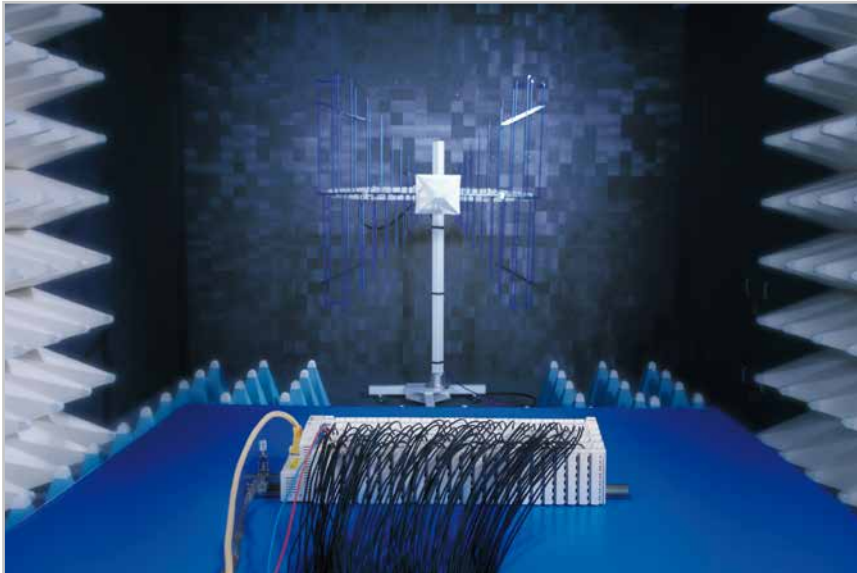

To isolate and eliminate any weak points during development in our electromagnetic compatibility laboratory, we can use bursts of up to 3 kV. All of our automation components have to meet stricter requirements than those defined in CE specifications and the requirements as specified by the international shipping classification organizations.

Time Saved

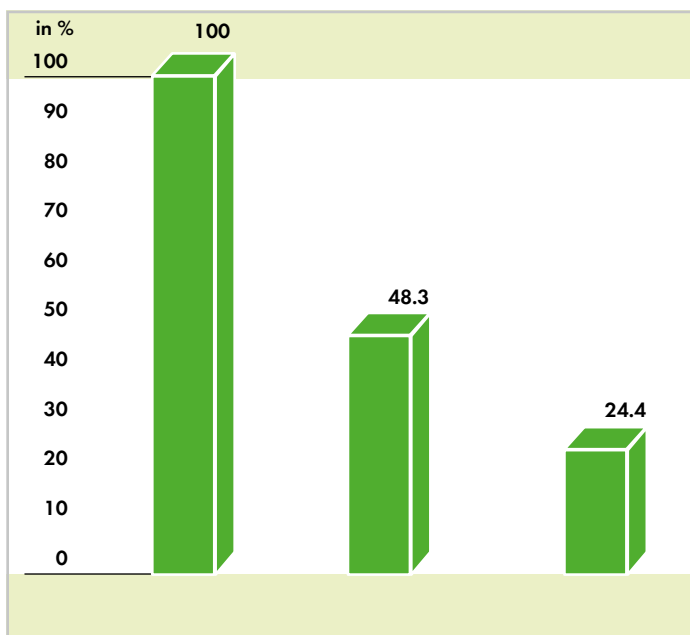

CAGE CLAMP® technology **significantly reduces wiring times**, which helps minimize labor costs.

Additional savings are provided via faster project commissioning **and** the elimination of service costs **due to maintenance-free connections.**

Savings go further by **reducing both material and labor costs** through eliminating the need to prepare ferrules or pin terminals prior to termination. Front-entry terminal blocks are specified for top-tier designs because they minimize both install time and effort.

Average manual wiring times in a percentage comparison (per MTM)

Rail-Mounted Terminal Block Systems

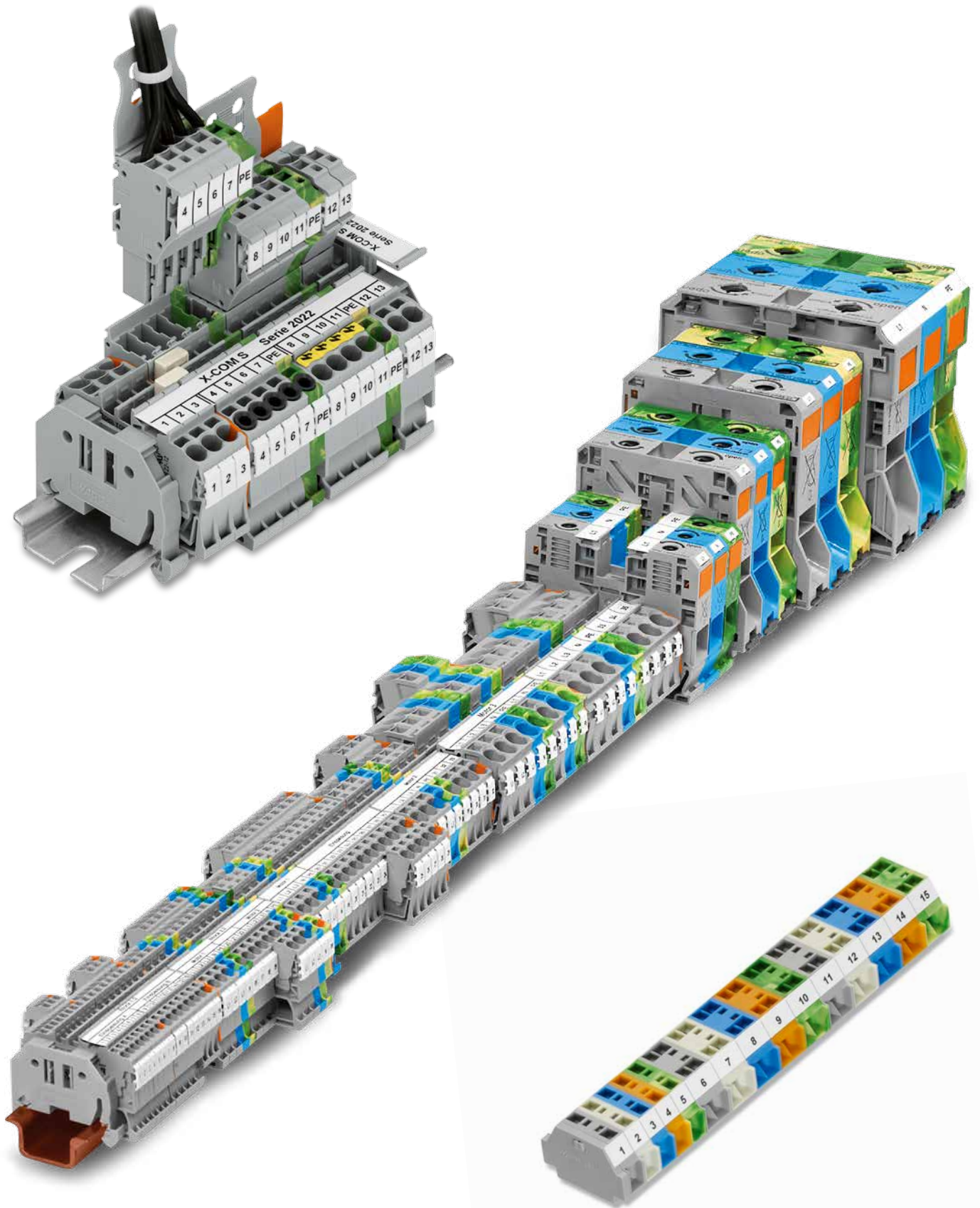

PCB Terminal Blocks and Connectors WINSTA® – The Pluggable Connection System

1

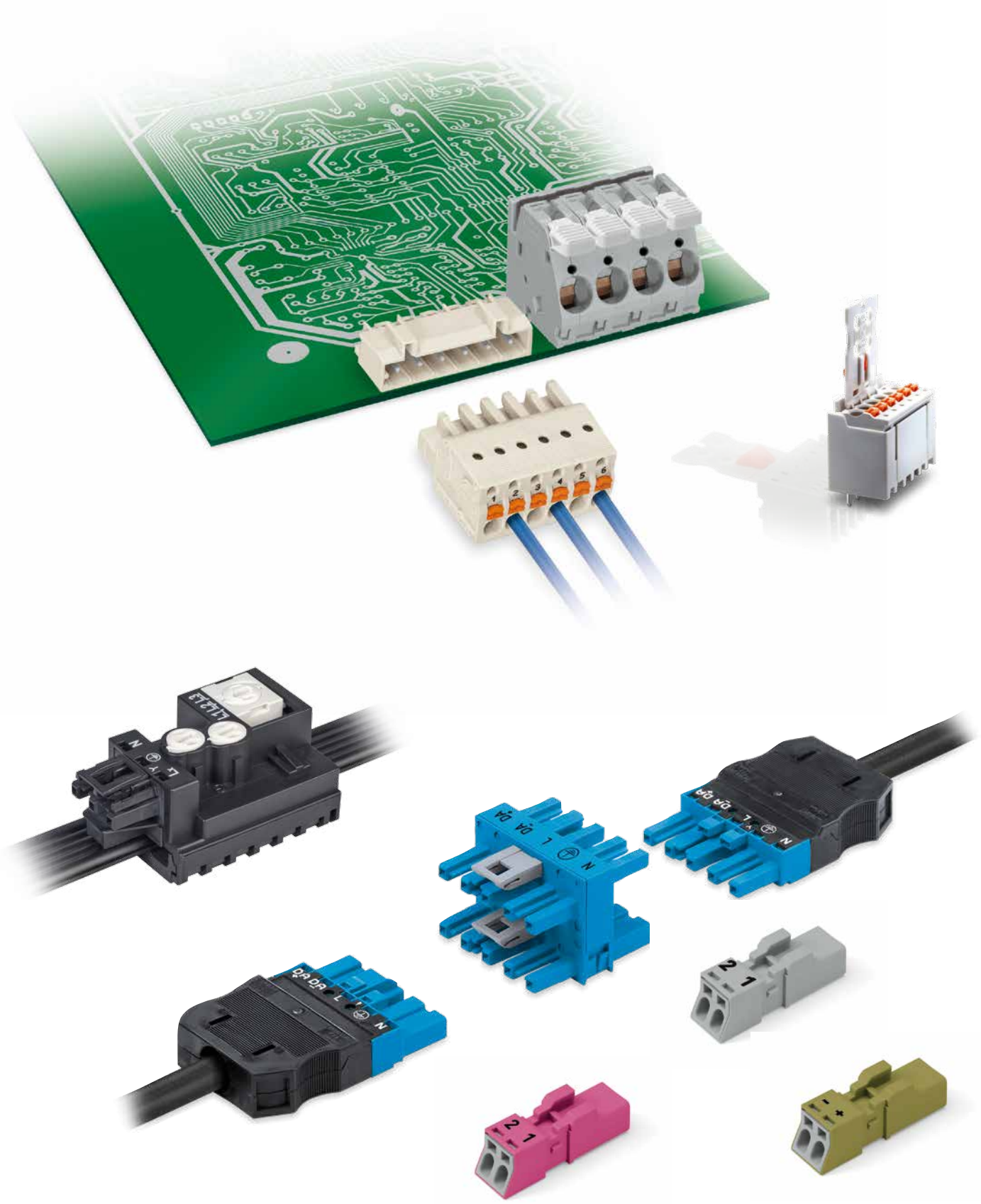

TOPJOB® S Rail-Mounted Terminal Blocks – Description and Installation –

Conductor termination/removal



Push-in termination: Solid conductors ranging from at least two sizes below to one size above the rated cross-section can be inserted directly – without tools.



Connecting fine-stranded conductors without ferrules, or small cross-sectional conductors that cannot be pushed in, is performed similarly to the original CAGE CLAMP® – just use a screwdriver.

Testing

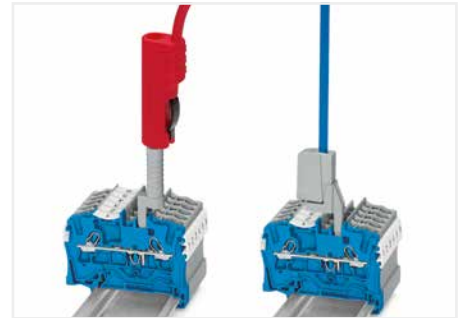

Testing TOPJOB® S Rail-Mounted Terminal Blocks via Test Plug Adapter or Testing Tap

Conductor removal is performed with a screwdriver, just like CAGE CLAMP®.

Commoning

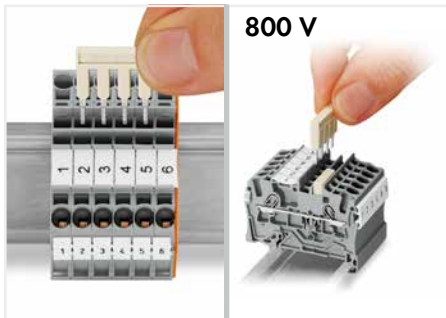

Twin integrated, spring-loaded jumper system allows use of comb-style jumper bars, test plugs and connectors. Jumper bars rated at 800 V (ex works)

Commoning

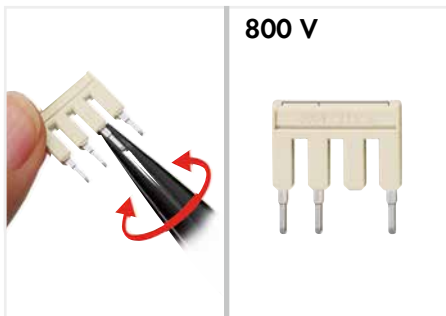

Jumper contacts that are not required can be broken off and removed, the upper-side of the jumper can then be marked accordingly. Applies to 2001, 2002 and 2004 Series.

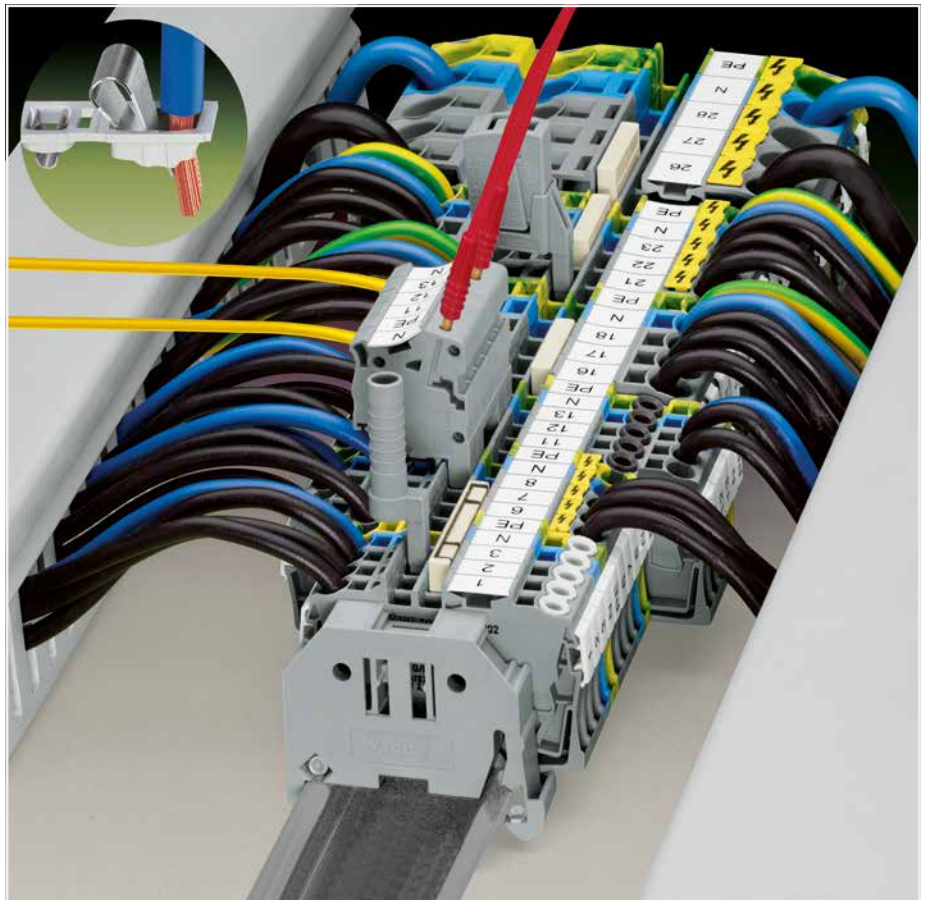

Marking



Both WAGO "smartDESIGNER" Software and Thermal Transfer Printer generate the marking.

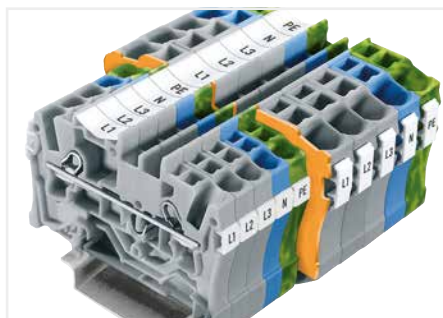

TOPJOB® S offers three marking positions for WMB or miniature WSB markers, as well as centered full-length marking strips.

Pre-assembled connectors

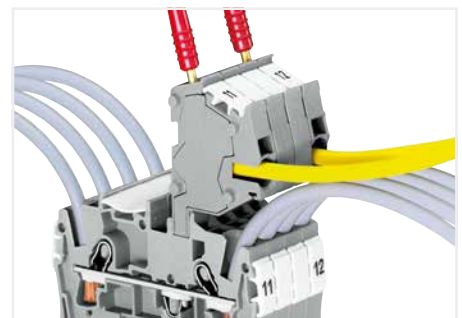

Pre-assembled connectors with Push-in CAGE CLAMP® connection provide an additional connection option.









For information on Push-in CAGE CLAMP® connection, see page 14.

TOPJOB® S

Rail-Mounted Terminal Blocks 1.0 (1.5) mm²









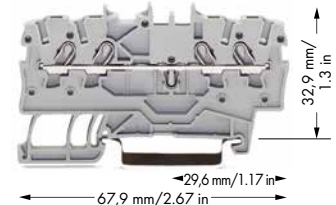
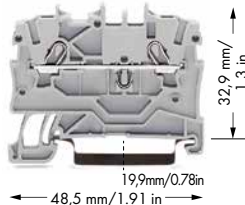
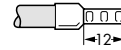













2000 Series

PUSH-IN CAGE CLAMP®









0.14 ... 1.0 (1.5) mm² ① 24 ... 16 AWG 600 V, 10 A  600 V, 10 A  I_N 13.5 A (18 A) Terminal block width: 3.5 mm / 0.138 in.  9 ... 11 mm / 0.39 in. ② Approvals	0.14 ... 1.0 (1.5) mm² ① 24 ... 16 AWG 600 V, 10 A  600 V, 10 A  I_N 13.5 A (18 A) Terminal block width: 3.5 mm / 0.138 in.  9 ... 11 mm / 0.39 in. ② Approvals	0.14 ... 1.0 (1.5) mm² ① 24 ... 16 AWG 600 V, 10 A  600 V, 10 A  I_N 13.5 A (18 A) Terminal block width: 3.5 mm / 0.138 in.  9 ... 11 mm / 0.39 in. ② Approvals
---	---	---

① Conductor range: 0.14 ... 1.5 mm² "s+fst"
 Push-in termination: 0.5 ... 1.5 mm² "s" and 0.5 ... 1 mm² "insulated ferrule, 12 mm"





















Color	Item No.	Pack. Unit	Color	Item No.	Pack. Unit	Color	Item No.	Pack. Unit
2-conductor through terminal block			3-conductor through terminal block			4-conductor through terminal block		
gray 	2000-1201	100	gray 	2000-1301	100	gray 	2000-1401	100
blue 	2000-1204 ③	100	blue 	2000-1304 ③	100	blue 	2000-1404 ③	100
orange 	2000-1202	100	orange 	2000-1302	100	orange 	2000-1402	100
red 	2000-1203	100	red 	2000-1303	100	red 	2000-1403	100
black 	2000-1205	100	black 	2000-1305	100	black 	2000-1405	100
yellow 	2000-1206	100	yellow 	2000-1306	100	yellow 	2000-1406	100
2-conductor ground terminal block			3-conductor ground terminal block			4-conductor ground terminal block		
green-yellow 	2000-1207	100	green-yellow 	2000-1307	100	green-yellow 	2000-1407	100
						Double potential terminal block		
						gray 	2000-2141	50

Item-Specific Accessories

End and intermediate plate, 0.7 mm thick	End and intermediate plate, 0.7 mm thick	End and intermediate plate, 0.7 mm thick
  2000-1292 100 (4x25)  2000-1291 100 (4x25)	  2000-1392 100 (4x25)  2000-1391 100 (4x25)	  2000-1492 100 (4x25)  2000-1491 100 (4x25)

Accessories, 2000 Series

Appropriate marking systems: **WMB/Marking Strips/WMB Inline**

Push-in type jumper bar, insulated,  I_N 14 A, light gray 2-way 2000-402 200 (8x25) 3-way 2000-403 200 (8x25) 4-way 2000-404 200 (8x25) : 10-way 2000-410 100 (4x25) .../000-005  .../000-006	Push-in type jumper bar, insulated,  I_N 14 A, light gray 1 to 3 2000-433 200 (8x25) 1 to 4 2000-434 200 (8x25) 1 to 5 2000-435 100 (4x25) : 1 to 10 2000-440 100 (4x25)	Star point jumper, insulated,  I_N = I_N terminal block, light gray 1-3-5 2000-405/011-000 100 (4x25)
Protective warning marker, with high-voltage symbol, for 5 terminal blocks   2000-115 100 (4x25)	WMB Multi marking system, plain, 10 strips with 10 markers per card for 3.5 mm terminal block width,   793-3501 5	Delta jumper, insulated,  I_N = I_N terminal block, light gray 1-2 3-4 5-6 2000-406/020-000 100 (4x25)
Operating tool with a partially insulated shaft, type 1, (2.5 x 0.4) mm blade  210-719 1	WMB Inline, plain, 3.5 mm, 2,300 WMB markers per roll  2009-113 1	Marking strips, plain 11 mm wide, 50 m roll   2009-110 1
Insulated ferrules, extra long, for TOPJOB® S terminal blocks, see page 259 	③ Suitable for Ex i applications ④ Suitable for Ex e II applications 550 V, 22 A	Test plug adapter, for 4 mm Ø test plug   2009-174 100 (4x25)
		Testing tap, for max. 2.5 mm²   2009-182 100 (4x25)

② For all approvals and corresponding ratings, visit www.wago.com.

For technical information and abbreviations, see technical section.

TOPJOB® S

Through/Ground/Shield Conductor and Ex Terminal Blocks 1.5 (2.5) mm²

2001 Series

<p>0.25 ... 1.5 (2.5) mm² ① 22 ... 14 AWG 800 V/8 kV/3 I_N 18 A (24 A)</p> <p>Terminal block width: 4.2 mm / 0.165 in. 9 ... 11 mm / 0.39 in.</p> <p>② Approvals</p>	<p>0.25 ... 1.5 (2.5) mm² ① 22 ... 14 AWG 800 V/8 kV/3 I_N 18 A (24 A)</p> <p>Terminal block width: 4.2 mm / 0.165 in. 9 ... 11 mm / 0.39 in.</p> <p>② Approvals</p>	<p>0.25 ... 1.5 (2.5) mm² ① 22 ... 14 AWG 800 V/8 kV/3 I_N 18 A (24 A)</p> <p>Terminal block width: 4.2 mm / 0.165 in. 9 ... 11 mm / 0.39 in.</p> <p>② Approvals</p>
---	---	---

① Conductor range: 0.25 ... 2.5 mm² "s+f-st"
Push-in termination: 0.5 ... 2.5 mm² "s" and 0.75 ... 1.5 mm² "insulated ferrule, 12 mm"

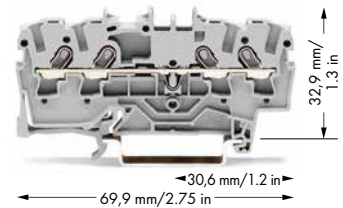
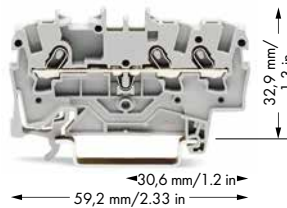
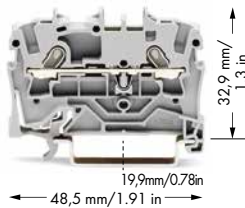
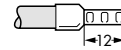

Color	Item No.	Pack. Unit	Color	Item No.	Pack. Unit	Color	Item No.	Pack. Unit
2-conductor through terminal block			3-conductor through terminal block			4-conductor through terminal block		
gray	2001-1201	100	gray	2001-1301	100	gray	2001-1401	100
blue	2001-1204 ③	100	blue	2001-1304 ③	100	blue	2001-1404 ③	100
orange	2001-1202	100	orange	2001-1302	100	orange	2001-1402	100
red	2001-1203	100	red	2001-1303	100	red	2001-1403	100
black	2001-1205	100	black	2001-1305	100	black	2001-1405	100
yellow	2001-1206	100	yellow	2001-1306	100	yellow	2001-1406	100
2-conductor ground terminal block			3-conductor ground terminal block			4-conductor ground terminal block		
green-yellow	2001-1207	100	green-yellow	2001-1307	100	green-yellow	2001-1407	100
2-cond. shield conductor terminal block			3-cond. shield conductor terminal block			4-cond. shield conductor terminal block		
white	2001-1208	100	white	2001-1308	100	white	2001-1408	100
Other terminal blocks with the same profile:			Other terminal blocks with the same profile:			Other terminal blocks with the same profile:		
Diode	2001-1211/1000-411 ④		Diode	2001-1311/1000-411 ④		Diode	2001-1411/1000-411 ④	
			LED	2001-1321/1000-434 ④		Diode	2001-1411/1000-434 ④	
						Double-potential	2001-1441 ④	

Item-Specific Accessories

Separator for Ex e/Ex i applications, see page 30

<p>End and intermediate plate, 0.8 mm thick</p> <p>2002-1292 100 (4x25)</p> <p>2002-1291 100 (4x25)</p>	<p>End and intermediate plate, 0.8 mm thick</p> <p>2002-1392 100 (4x25)</p> <p>2002-1391 100 (4x25)</p>	<p>End and intermediate plate, 0.8 mm thick</p> <p>2002-1492 100 (4x25)</p> <p>2002-1491 100 (4x25)</p>
<p>Separator, oversized, 0.8 mm thick</p> <p>2002-1294 100 (4x25)</p> <p>2002-1293 100 (4x25)</p>	<p>Separator, oversized, 0.8 mm thick</p> <p>2002-1394 100 (4x25)</p> <p>2002-1393 100 (4x25)</p>	<p>Separator, oversized, 0.8 mm thick</p> <p>2002-1494 100 (4x25)</p> <p>2002-1493 100 (4x25)</p>

Accessories, 2001 Series

Appropriate marking systems: WMB/Marking Strips

<p>Push-in type jumper bar, insulated,</p> <p>I_N 18 A, light gray</p> <p>2-way 2001-402 200 (8x25)</p> <p>3-way 2001-403 200 (8x25)</p> <p>4-way 2001-404 200 (8x25)</p> <p>: :</p> <p>10-way 2001-410 100 (4x25)</p>	<p>Push-in type jumper bar, insulated,</p> <p>I_N 18 A, light gray</p> <p>1 to 3 2001-433 200 (8x25)</p> <p>1 to 4 2001-434 200 (8x25)</p> <p>1 to 5 2001-435 100 (4x25)</p> <p>: :</p> <p>1 to 10 2001-440 100 (4x25)</p>	<p>Push-in type wire jumper, insulated,</p> <p>I_N 16 A, 1.5 mm² conductor size</p> <p>60 mm 2009-412 100 (10x10)</p> <p>110 mm 2009-414 100 (10x10)</p> <p>250 mm 2009-416 100 (10x10)</p>
<p>Insulation stop,</p> <p>5 pcs/strip</p> <p>2001-171 0.25-0.5 mm² 200 (8x25)</p>	<p>Protective warning marker, with high-voltage symbol,</p> <p>for 5 terminal blocks</p> <p>2001-115 100 (4x25)</p>	<p>Star point jumper, insulated,</p> <p>I_N = I_N terminal block, light gray</p> <p>1-3-5 2001-405/011-000 100 (4x25)</p>
<p>WMB Multi marking system, plain,</p> <p>10 strips with 10 markers per card, stretchable from 4 ... 4.2 mm</p> <p>793-4501 5</p>	<p>Operating tool with a partially insulated shaft,</p> <p>type 1, (2.5 x 0.4) mm blade</p> <p>210-719 1</p>	<p>Modular TOPJOB® S connector, can be snapped together,</p> <p>I_N 18 A, for jumper contact slot</p> <p>2001-511 100 (4x25)</p>
<p>Marking strip, plain,</p> <p>11 mm wide, 50 m roll</p> <p>2009-110 1</p>	<p>③ Suitable for Ex i applications ④ Suitable for Ex e II applications 550 V, 17 A</p>	<p>Spacer module, can be snapped together</p> <p>2001-549 100 (4x25)</p>
		<p>Insulated ferrules, extra long,</p> <p>for TOPJOB® S terminal blocks, see page 259</p>

② For all approvals and corresponding ratings, visit www.wago.com.
④ See Full Line Catalog or visit www.wago.com.

For technical information and abbreviations, see technical section.

TOPJOB® S

Through/Ground/Shield Conductor and Ex Terminal Blocks 2.5 (4) mm²

2002 Series

PUSH-IN CAGE CLAMP®

0.25 ... 2.5 (4) mm ² ① 800 V/8 kV/3 I _N 24 A (32 A) Terminal block width: 5.2 mm / 0.205 in. 10 ... 12 mm / 0.43 in.	22 ... 12 AWG 600 V, 20 A ② 600 V, 20 A ③	0.25 ... 2.5 (4) mm ² ① 800 V/8 kV/3 I _N 24 A (32 A) Terminal block width: 5.2 mm / 0.205 in. 10 ... 12 mm / 0.43 in.	22 ... 12 AWG 600 V, 20 A ② 600 V, 20 A ③	0.25 ... 2.5 (4) mm ² ① 800 V/8 kV/3 I _N 24 A (32 A) Terminal block width: 5.2 mm / 0.205 in. 10 ... 12 mm / 0.43 in.	22 ... 12 AWG 600 V, 20 A ② 600 V, 20 A ③
② Approvals		② Approvals		② Approvals	

- ① Conductor range: 0.25 ... 4 mm² "s+f-st"
Push-in termination: 0.75 ... 4 mm² "s" and
0.75 ... 2.5 mm² "insulated ferrule, 12 mm"

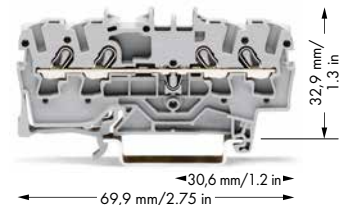
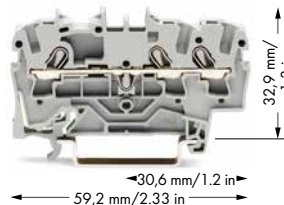
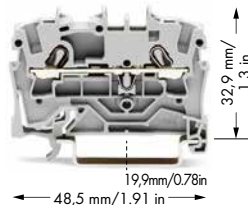

Color	Item No.	Pack. Unit	Color	Item No.	Pack. Unit	Color	Item No.	Pack. Unit
2-conductor through terminal block			3-conductor through terminal block			4-conductor through terminal block		
gray ④	2002-1201	100	gray ④	2002-1301	100	gray ④	2002-1401	100
blue ④	2002-1204 ③	100	blue ④	2002-1304 ③	100	blue ④	2002-1404 ③	100
orange ④	2002-1202	100	orange ④	2002-1302	100	orange ④	2002-1402	100
red ④	2002-1203	100	red ④	2002-1303	100	red ④	2002-1403	100
black ④	2002-1205	100	black ④	2002-1305	100	black ④	2002-1405	100
yellow ④	2002-1206	100	yellow ④	2002-1306	100	yellow ④	2002-1406	100
2-conductor ground terminal block			3-conductor ground terminal block			4-conductor ground terminal block		
green-yellow ④	2002-1207	100	green-yellow ④	2002-1307	100	green-yellow ④	2002-1407	100
2-cond. shield conductor terminal block			3-cond. shield conductor terminal block			4-cond. shield conductor terminal block		
white	2002-1208	100	white	2002-1308	100	white	2002-1408	100
Other terminal blocks with the same profile:			Other terminal blocks with the same profile:			Other terminal blocks with the same profile:		
Diode	2002-1211/1000-411	Page 60	Diode	2002-1311/1000-411	Page 60	Diode	2002-1411/1000-411	Page 60
			LED	2002-1321/1000-434	Page 60	Diode	2002-1411/1000-434	Page 60
						Double-potential	2002-1441 ④	

Item-Specific Accessories

Separator for Ex e/Ex i applications, see page 30

End and intermediate plate, 0.8 mm thick	End and intermediate plate, 0.8 mm thick	End and intermediate plate, 0.8 mm thick
<ul style="list-style-type: none"> 2002-1292 100 (4x25) 2002-1291 100 (4x25) 	<ul style="list-style-type: none"> 2002-1392 100 (4x25) 2002-1391 100 (4x25) 	<ul style="list-style-type: none"> 2002-1492 100 (4x25) 2002-1491 100 (4x25)
Separator, oversized, 0.8 mm thick	Separator, oversized, 0.8 mm thick	Separator, oversized, 0.8 mm thick
<ul style="list-style-type: none"> 2002-1294 100 (4x25) 2002-1293 100 (4x25) 	<ul style="list-style-type: none"> 2002-1394 100 (4x25) 2002-1393 100 (4x25) 	<ul style="list-style-type: none"> 2002-1494 100 (4x25) 2002-1493 100 (4x25)

Accessories, 2002 Series

Appropriate marking systems: WMB/Marking Strips/WMB Inline/Miniature WSB

Adjacent jumper for continuous commoning, insulated, I _N 25 A, light gray 2-way 2002-400 100 (4x25) 1 to 3 2002-423 100 (4x25)	Push-in type jumper bar, insulated, I _N 25 A, light gray 1 to 3 2002-433 200 (8x25) : 1 to 10 2002-440 100 (4x25)	Staggered jumper, insulated, I _N 25 A, light gray 2-way 2002-472 100 (4x25) 3-way 2002-473 100 (4x25) 4-way 2002-474 100 (4x25) : 12-way 2002-482 50 (2x25)
Push-in type jumper bar, insulated, I _N 25 A, light gray 2-way 2002-402 200 (8x25) 3-way 2002-403 200 (8x25) 4-way 2002-404 200 (8x25) : 10-way 2002-410 100 (4x25)	Insulation stop, 5 pcs/strip ○ 2002-171 0.25-0.5 mm ² ● 2002-172 0.75-1 mm ² 200 (8x25)	Star point jumper, insulated, I _N = I _N terminal block, light gray 1-3-5 2002-405/011-000 100 (4x25)
● .../000-005 ● .../000-006	Protective warning marker, with high-voltage symbol, for 5 terminal blocks ● 2002-115 100 (4x25)	Delta jumper, insulated, I _N = I _N terminal block, light gray 1-2 3-4 5-6 2004-406/020-000 100 (4x25)
Push-in type wire jumper, insulated, I _N 16 A, 1.5 mm ² conductor size 60 mm 2009-412 100 (10x10) 110 mm 2009-414 100 (10x10) 250 mm 2009-416 100 (10x10)	Operating tool with a partially insulated shaft, type 2, (3.5 x 0.5) mm blade 210-720 1	Modular TOPJOB® S L-test plug, can be snapped together, I_N 18 A, for conductor entry ● 2002-611 100 (4x25)
WMB Multi marking system, plain, 10 strips with 10 markers per card, stretchable from 5 ... 5.2 mm ○ 793-5501 5	③ Suitable for Ex i applications ④ Suitable for Ex e II applications 550 V, 22 A	Spacer module, can be snapped together ● 2002-649 100 (4x25)



Please find the entire product range in our Full Line Catalog. For additional information, visit www.wago.com.

④ See Full Line Catalog or visit www.wago.com.

TOPJOB® S

Through/Ground/Shield Conductor and Ex Terminal Blocks 2.5 (4) mm²

2002 Series

<p>0.25 ... 2.5 (4) mm² ①</p> <p>800 V/8 kV/3 I_N 24 A (32 A)</p> <p>Terminal block width: 5.2 mm / 0.205 in.</p> <p> 10 ... 12 mm / 0.43 in.</p> <p>② Approvals</p>	<p>22 ... 12 AWG 600 V, 20 A ③ 600 V, 20 A ④</p>	<p>0.25 ... 2.5 (4) mm² ①</p> <p>800 V/8 kV/3 I_N 24 A (32 A)</p> <p>Terminal block width: 5.2 mm / 0.205 in.</p> <p> 10 ... 12 mm / 0.43 in.</p> <p>② Approvals</p>	<p>22 ... 12 AWG 600 V, 20 A ③ 600 V, 20 A ④</p>
--	--	--	--

① Conductor range: 0.25 ... 4 mm² "st+st"
Push-in termination: 0.75 ... 4 mm² "s"
and 0.75 ... 2.5 mm² "insulated ferrule, 12 mm"

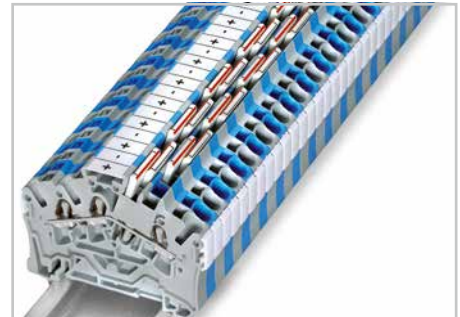
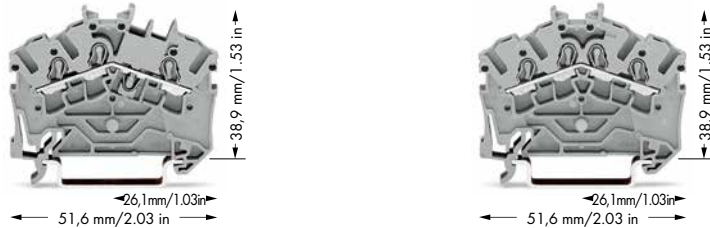



Color	Item No.	Pack. Unit	Color	Item No.	Pack. Unit
3-conductor through terminal block			4-conductor through terminal block		
gray ④	2002-6301	100	gray ④	2002-6401	100
blue ④	2002-6304 ③	100	blue ④	2002-6404 ③	100
orange ④	2002-6302	100	orange ④	2002-6402	100
Additional colors will be available soon.			Additional colors will be available soon.		
3-conductor ground terminal block			4-conductor ground terminal block		
green-yellow ④	2002-6307	100	green-yellow ④	2002-6407	100
3-cond. shield conductor terminal block			Notice: These terminal blocks cannot be com-		
white	2002-6308	100	moned.		

3- and 4-conductor terminal blocks

WAGO's TOPJOB® S Rail-Mounted Terminal Blocks have a 35-degree conductor entry angle permitting a very small bend radius and an extremely short wiring distance to the cable duct. Space- and cost-saving solutions for switchgear and control cabinet applications that use the LSC wiring system from Lütze. The design allows cable duct to be placed very close to the terminal blocks, keeping its height relatively low.

An end plate must be applied when changing from a 3-conductor terminal block to a 4-conductor terminal block and vice versa.

Item-Specific Accessories

<p>End and intermediate plate, 0.8 mm thick</p> <p> ④</p> <p>● 2002-6392 100 (4x25)</p> <p>○ 2002-6391 100 (4x25)</p>	<p>End and intermediate plate, 0.8 mm thick</p> <p> ④</p> <p>● 2002-6392 100 (4x25)</p> <p>○ 2002-6391 100 (4x25)</p>
---	---

Accessories, 2002 Series

Appropriate marking systems:
WMB/Marking Strips/WMB Inline/Miniature WSB

<p>Adjacent jumper for continuous commoning, insulated, I_N 25 A, light gray</p> <p>2-way 2002-400 100 (4x25)</p> <p>1 to 3 2002-423 100 (4x25)</p>	<p>Insulation stop, 5 pcs/strip</p> <p>○ 2002-171 0.25-0.5 mm²</p> <p>● 2002-172 0.75-1 mm²</p> <p>200 (8x25)</p>
<p>Push-in type jumper bar, insulated, I_N 25 A, light gray</p> <p>2-way 2002-402 200 (8x25)</p> <p>: :</p> <p>10-way 2002-410 100 (4x25)</p> <p>● .../000-005 ● .../000-006</p>	<p>Protective warning marker, with high-voltage symbol, for 5 terminal blocks</p> <p>● 2002-115 100 (4x25)</p>
<p>Push-in type jumper bar, insulated, I_N 25 A, light gray</p> <p>1 ... 3 2002-433 200 (8x25)</p> <p>: :</p> <p>1 ... 10 2002-440 100 (4x25)</p>	<p>Test plug adapter, for 4 mm Ø test plug</p> <p>○ 2009-174 100 (4x25)</p> <p>Testing tap, for max. 2.5 mm²</p> <p>○ 2009-182 100 (4x25)</p>
<p>Staggered jumper, insulated, I_N 25 A, light gray</p> <p>2-way 2002-472 100 (4x25)</p> <p>3-way 2002-473 100 (4x25)</p> <p>4-way 2002-474 100 (4x25)</p> <p>5-way 2002-475 50 (2x25)</p> <p>: :</p> <p>12-way 2002-482 50 (2x25)</p>	<p>Banana plugs, only for safety extra-low voltage (42 V)</p> <p>● 215-212 50</p> <p>● 215-311 50</p> <p>For additional colors, see page 262.</p>
<p>Modular TOPJOB® S connector, can be snapped together, I_N 24 A, for jumper contact slot</p> <p>○ 2002-511 100 (4x25)</p>	<p>Insulated ferrules, extra long, for TOPJOB® S terminal blocks (see page 259)</p>
<p>Spacer module, can be snapped together</p> <p>○ 2002-549 100 (4x25)</p>	<p>Operating tool,</p> <p>3.5 mm and 2.5 mm blades</p> <p>● 2009-309 1</p>
<p>Operating tool with a partially insulated shaft, type 2, (3.5 x 0.5) mm blade</p> <p>● 210-720 1</p>	<p>③ Suitable for Ex i applications</p> <p>④ Suitable for Ex e II applications 550 V, 22 A</p>

Through Terminal Block Accessories, 2001 ... 2006 Series

<p>Diode module,</p> <p>I_N 1 A, 10.4 mm wide, gray</p> <p>● 2002-880/1000-411 50</p>
<p>LED module, with red LED,</p> <p>I_N ≤ 3 mA, 10.4 mm wide, gray</p> <p>12 ... 30 V ● 2002-880/1000-541 50</p>
<p>LED module, with red LED,</p> <p>I_N ≤ 3 mA, 10.4 mm wide, gray</p> <p>30 ... 65 V ● 2002-880/1000-542 50</p>
<p>LED module, with red LED,</p> <p>I_N ≤ 3 mA, 10.4 mm wide, gray</p> <p>230 V ● 2002-880/1000-836 50</p>

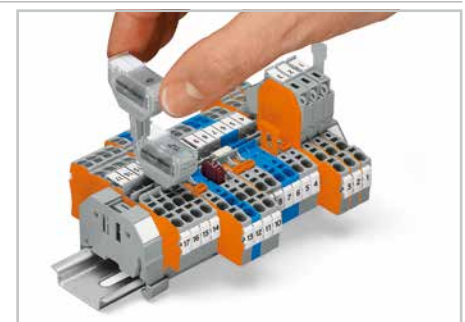

Plugging a diode module into a through terminal block.

For empty component plug housings, see page 236.

② For all approvals and corresponding ratings, visit www.wago.com.









For technical information and abbreviations, see "Technical Section."

TOPJOB® S

Through/Ground/Shield Conductor and Ex Terminal Blocks 4 (6) mm²









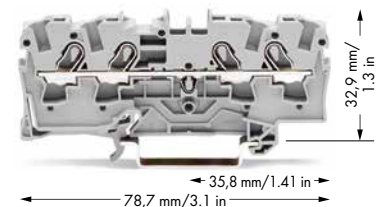
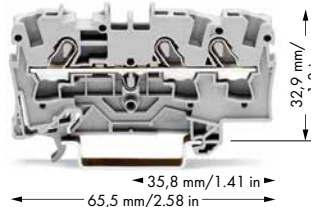
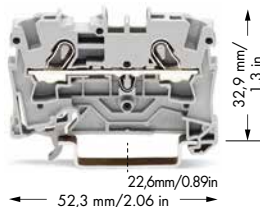















2004 Series

PUSH-IN CAGE CLAMP®

0.5 ... 4 (6) mm² ① 800 V/8 kV/3 I_N 32 A (41 A) Terminal block width: 6.2 mm / 0.244 in.  11 ... 13 mm / 0.47 in. ② Approvals	20 ... 10 AWG 600 V, 30 A  600 V, 30 A 	0.5 ... 4 (6) mm² ① 800 V/8 kV/3 I_N 32 A (41 A) Terminal block width: 6.2 mm / 0.244 in.  11 ... 13 mm / 0.47 in. ② Approvals	20 ... 10 AWG 600 V, 30 A  600 V, 30 A 	0.5 ... 4 (6) mm² ① 800 V/8 kV/3 I_N 32 A (41 A) Terminal block width: 6.2 mm / 0.244 in.  11 ... 13 mm / 0.47 in. ② Approvals	20 ... 10 AWG 600 V, 30 A  600 V, 30 A 
---	--	---	--	---	--



















① Conductor range: 0.5 ... 6 mm² "s+f-st"
 Push-in termination: 1 ... 6 mm² "s" and
 0.75 ... 4 mm² "insulated ferrule, 12 mm"



Color	Item No.	Pack. Unit	Color	Item No.	Pack. Unit	Color	Item No.	Pack. Unit
2-conductor through terminal block			3-conductor through terminal block			4-conductor through terminal block		
gray 	2004-1201	100	gray 	2004-1301	100	gray 	2004-1401	100
blue 	2004-1204 ③	100	blue 	2004-1304 ③	100	blue 	2004-1404 ③	100
orange 	2004-1202	100	orange 	2004-1302	100	orange 	2004-1402	100
red 	2004-1203	100	red 	2004-1303	100	red 	2004-1403	100
black 	2004-1205	100	black 	2004-1305	100	black 	2004-1405	100
yellow 	2004-1206	100	yellow 	2004-1306	100	yellow 	2004-1406	100
2-conductor ground terminal block			3-conductor ground terminal block			4-conductor ground terminal block		
green-yellow 	2004-1207	100	green-yellow 	2004-1307	100	green-yellow 	2004-1407	100
2-cond. shield conductor terminal block			3-cond. shield conductor terminal block			4-cond. shield conductor terminal block		
white 	2004-1208	100	white 	2004-1308	100	white 	2004-1408	100



















Item-Specific Accessories

Separator for Ex e/Ex i applications, see page 30

End and intermediate plate, 1 mm thick  <ul style="list-style-type: none"> orange  2004-1292 100 (4x25) gray  2004-1291 100 (4x25) 	End and intermediate plate, 1 mm thick  <ul style="list-style-type: none"> orange  2004-1392 100 (4x25) gray  2004-1391 100 (4x25) 	End and intermediate plate, 1 mm thick  <ul style="list-style-type: none"> orange  2004-1492 100 (4x25) gray  2004-1491 100 (4x25)
Separator, oversized, 0.8 mm thick  <ul style="list-style-type: none"> orange  2004-1294 100 (4x25) gray  2004-1293 100 (4x25) 	Separator, oversized, 0.8 mm thick  <ul style="list-style-type: none"> orange  2004-1394 100 (4x25) gray  2004-1393 100 (4x25) 	Separator, oversized, 0.8 mm thick  <ul style="list-style-type: none"> orange  2004-1494 100 (4x25) gray  2004-1493 100 (4x25)

Accessories, 2004 Series

Appropriate marking systems: WMB/Marking Strips/WMB Inline/Miniature WSB







Push-in type jumper bar, insulated, I_N 32 A, light gray  <ul style="list-style-type: none"> 2-way 2004-402 200 (8x25) 3-way 2004-403 200 (8x25) 4-way 2004-404 100 (4x25) : : 10-way 2004-410 100 (4x25) 	Push-in type jumper bar, insulated, I_N 32 A, light gray  <ul style="list-style-type: none"> 1 to 3 2004-433 200 (8x25) 1 to 4 2004-434 200 (8x25) 1 to 5 2004-435 100 (4x25) : : 1 to 10 2004-440 100 (4x25) 	Delta jumper, insulated, $I_N = I_N$ terminal block, light gray  <ul style="list-style-type: none"> 1-2 3-4 5-6 2004-406/020-000 100 (4x25)
Insulation stop, 5 pcs/strip  <ul style="list-style-type: none"> white  2004-171 0.25-0.5 mm² gray  2004-172 0.75-1 mm² 	Protective warning marker, with high-voltage symbol, for 5 terminal blocks  <ul style="list-style-type: none"> yellow  2004-115 100 (4x25) 	Star point jumper, insulated, $I_N = I_N$ terminal block, light gray  <ul style="list-style-type: none"> 1-3-5 2004-405/011-000 100 (4x25)
WMB Multi marking system, plain, 10 strips with 10 markers per card, stretchable from 5 ... 5.2 mm  <ul style="list-style-type: none"> white  793-5501 5 	Operating tool with a partially insulated shaft, type 2, (3.5 x 0.5) mm blade  <ul style="list-style-type: none"> 210-720 1 	Modular TOPJOB® S connector, can be snapped together, I_N 32 A, for jumper contact slot  <ul style="list-style-type: none"> gray  2004-511 100 (4x25)
Marking strip, plain, 11 mm wide, 50 m roll  <ul style="list-style-type: none"> white  2009-110 1 	③ Suitable for Ex i applications ④ Suitable for Ex e II applications 550 V, 30 A	Spacer module, can be snapped together  <ul style="list-style-type: none"> gray  2004-549 100 (4x25)
Insulated ferrules, extra long,  for TOPJOB® S terminal blocks, see page 259		

Please find the entire product range in our Full Line Catalog. For additional information, visit www.wago.com.

TOPJOB® S









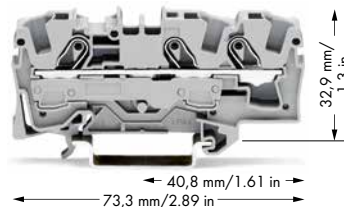
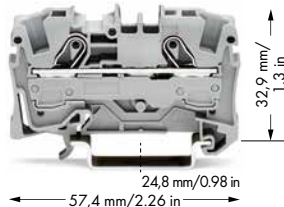







Through/Ground/Shield Conductor and Ex Terminal Blocks 6 (10) mm²

2006 Series

<p>0.5 ... 6 (10) mm² ①</p> <p>20 ... 8 AWG</p> <p>800 V/8 kV/3</p> <p>I_N 41 A (57 A)</p> <p>Terminal block width: 7.5 mm / 0.295 in.</p> <p> 13 ... 15 mm / 0.55 in.</p> <p>② Approvals</p>	<p>20 ... 8 AWG</p> <p>600 V, 50 A </p> <p>600 V, 50 A </p>	<p>0.5 ... 6 (10) mm² ①</p> <p>20 ... 8 AWG</p> <p>800 V/8 kV/3</p> <p>I_N 41 A (57 A)</p> <p>Terminal block width: 7.5 mm / 0.295 in.</p> <p> 13 ... 15 mm / 0.55 in.</p> <p>② Approvals</p>	<p>20 ... 8 AWG</p> <p>600 V, 50 A </p> <p>600 V, 50 A </p>	<p>Separator for Ex e/Ex i applications</p>
---	---	---	---	---











① Conductor range: 0.5 ... 10 mm² "s+fs"
 Push-in termination: 1.5 ... 10 mm² "s" and
 1.5 ... 6 mm² "insulated ferrule, 12 mm"



Color	Item No.	Pack. Unit	Color	Item No.	Pack. Unit	Color	Item No.	Pack. Unit
2-conductor through terminal block			3-conductor through terminal block			Separator for Ex e/Ex i applications,		
gray 	2006-1201	50	gray 	2006-1301	25	3 mm thick, orange		
blue 	2006-1204 ③	50	blue 	2006-1304 ③	25	90 mm wide	209-190	50 (2x25)
orange 	2006-1202	50	orange 	2006-1302	25	120 mm wide	209-191	50 (2x25)
2-conductor ground terminal block			3-conductor ground terminal block			125,5 mm wide	209-192	50 (2x25)
green-yellow 	2006-1207	50	green-yellow 	2006-1307	25			
2-cond. shield conductor terminal block								
white	2006-1208	50						
Item-Specific Accessories								
End and intermediate plate, 1 mm thick			End and intermediate plate, 1 mm thick					
	 2006-1292	100 (4x25)		 2006-1392	100 (4x25)			
	 2006-1291	100 (4x25)		 2006-1391	100 (4x25)			

Accessories, 2006 Series

Appropriate marking systems: **WMB/Marking Strips/WMB Inline/Miniature WSB**

<p>Push-in type jumper bar, insulated,</p> <p>I_N 41 A, light gray</p> <p>2-way 2006-402 50 (2x25)</p> <p>3-way 2006-403 50 (2x25)</p> <p>4-way 2006-404 50 (2x25)</p> <p>5-way 2006-405 50 (2x25)</p>	<p>Push-in type jumper bar, insulated,</p> <p>I_N 41 A, light gray</p> <p>1 to 3 2006-433 50 (2x25)</p> <p>1 to 4 2006-434 50 (2x25)</p> <p>1 to 5 2006-435 50 (2x25)</p>
<p>Star point jumper, insulated,</p> <p>I_N = I_N terminal block, light gray</p> <p>1-3-5 2006-405/011-000</p> <p>50 (2x25)</p>	<p>Step-down jumper, insulated,</p> <p>I_N 32 A, light gray</p> <p>2006-499 50 (2x25)</p>
<p>Protective warning marker, with high-voltage symbol, for 5 terminal blocks</p> <p> 2006-115 100 (4x25)</p>	<p>Operating tool,</p> <p>3.5 mm and 5.5 mm blades</p> <p>2009-310 1</p>
<p>Test plug adapter, for 4 mm Ø test plug</p> <p> 2009-174 100 (4x25)</p> <p>Testing tap, for max. 2.5 mm²</p> <p> 2009-182 100 (4x25)</p>	<p>Operating tool with a partially insulated shaft,</p> <p>type 3, (5.5 x 0.8) mm blade</p> <p>210-721 1</p>
<p>Modular TOPJOB® S connector, can be snapped together, I_N 32 A, for jumper contact slot</p> <p> 2006-511 100 (4x25)</p>	<p>Banana plugs, only for safety extra-low voltage (42 V)</p> <p> 215-212 50</p> <p> 215-311 50</p> <p>For additional colors, see page 262.</p>
<p>Spacer module, can be snapped together</p> <p> 2006-549 100 (4x25)</p>	<p>Marking strip, plain,</p> <p>11 mm wide, 50 m roll</p> <p> 2009-110 1</p>
<p>Insulated ferrules, extra long, for TOPJOB® S terminal blocks, see page 259</p> <p></p>	<p>③ Suitable for Ex i applications</p> <p> Suitable for Ex e II applications</p> <p>550 V, 38 A (2-conductor terminal blocks)</p> <p>550 V, 36 A (3-conductor terminal blocks)</p>

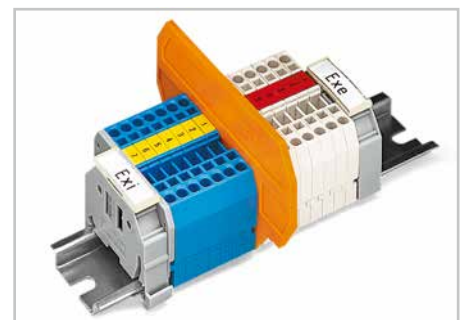

Separator for Ex e/Ex i applications
 According to EN 50020, a minimum distance of 50 mm must be kept between live parts of Ex e and Ex i circuits. The use of Ex e/Ex i separators is a space-saving solution when Ex e and Ex i terminal blocks are mounted on a common carrier rail.

Suitable for Series: 279 to 282, 2001, 2002 and 2004.

209-190 for 2-conductor terminal blocks
 209-191 for 2-, 3-, 4-conductor terminal blocks
 209-192 for double-deck terminal blocks

② For all approvals and corresponding ratings, visit www.wago.com.

For technical information and abbreviations, see "Technical Section."

TOPJOB® S

Through/Ground/Shield Conductor and Ex Terminal Blocks 10 (16) mm²

2010 Series

PUSH-IN CAGE CLAMP®

0.5 ... 10 (16) mm ² ① 800 V/8 kV/3 I _N 57 A (76 A) Terminal block width: 10 mm / 0.394 in. 17 ... 19 mm / 0.71 in.	20 ... 6 AWG 600 V, 65 A ② 600 V, 65 A ③	0.5 ... 10 (16) mm ² ① 800 V/8 kV/3 I _N 57 A (76 A) Terminal block width: 10 mm / 0.394 in. 17 ... 19 mm / 0.71 in.	20 ... 6 AWG 600 V, 65 A ② 600 V, 65 A ③	Step-down jumpers
② Approvals		② Approvals		

- ① Conductor range: 0.5 ... 16 mm² "s+fst"
Push-in termination: 2.5 ... 16 mm² "s" and
2.5 ... 10 mm² "insulated ferrule, 18 mm"

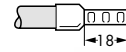
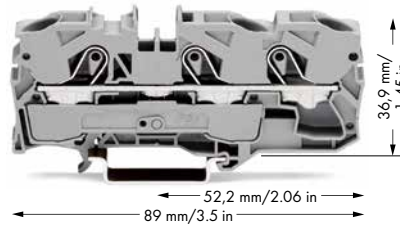
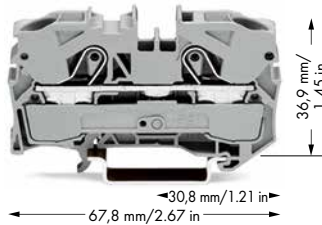

Color	Item No.	Pack. Unit	Color	Item No.	Pack. Unit	Item No.	Pack. Unit
2-conductor through terminal block			3-conductor through terminal block			Step-down jumper, insulated,	
gray ④	2010-1201	25	gray ④	2010-1301	25	I _N 32 A, light gray,	
blue ④	2010-1204 ③	25	blue ④	2010-1304 ③	25	commons 6/4 mm ² down to 4/2.5/1.5 mm ²	
orange ④	2010-1202	25	orange ④	2010-1302	25	2006-499	50 (2x25)
2-conductor ground terminal block			3-conductor ground terminal block			Step-down jumper, insulated,	
green-yellow ④	2010-1207	25	green-yellow ④	2010-1307	25	I _N 57 A, light gray,	
2-cond. shield conductor terminal block						commons 16/10 mm ² down to 10/6/4/2.5 mm ²	
white	2010-1208	25				2016-499	50 (2x25)
Item-Specific Accessories							
End and intermediate plate, 1 mm thick				End and intermediate plate, 1 mm thick			
	2010-1292	100 (4x25)		2010-1392	100 (4x25)		
	2010-1291	100 (4x25)		2010-1391	100 (4x25)		

Accessories, 2010 Series

Appropriate marking systems: WMB/Marking Strips/WMB Inline/Miniature WSB

Push-in type jumper bar, insulated, I _N 57 A, light gray		2-way 2010-402 50 (2x25)	Push-in type jumper bar, insulated, I _N 57 A, light gray		1 to 3 2010-433 50 (2x25)
		3-way 2010-403 50 (2x25)			1 to 4 2010-434 50 (2x25)
		4-way 2010-404 50 (2x25)			1 to 5 2010-435 50 (2x25)
		5-way 2010-405 50 (2x25)	Star point jumper, insulated, I _N = I _N terminal block, light gray		1-3-5 2010-405/011-000
Step-down jumper, insulated, I _N 32 A, light gray		2016-499 50 (2x25)			50 (2x25)
Protective warning marker, with high-voltage symbol, for 5 terminal blocks		2010-115 50 (2x25)	Finger guard, touch-proof cover protects unused conductor entries		2010-100 100 (4x25)
Test plug adapter, for 4 mm Ø test plug		2009-174 100 (4x25)	Operating tool with a partially insulated shaft, type 3, (5.5 x 0.8) mm blade		210-721 1
Testing tap, for max. 2.5 mm²		2009-182 100 (4x25)	Banana plugs, only for safety extra-low voltage (42 V)		215-212 50
Modular TOPJOB® S connector, can be snapped together, I _N 32 A, for jumper contact slot		2010-511 100 (4x25)			215-311 50
Spacer module, can be snapped together		2010-549 100 (4x25)	WMB Multi marking system, plain, 10 strips with 10 markers per card, stretchable from 5 ... 5.2 mm		793-5501 5
Insulated ferrules, extra long, for TOPJOB® S terminal blocks, see page 259			③ Suitable for Ex i applications ④ Suitable for Ex e II applications 550 V, 51 A (2-conductor terminal blocks) 550 V, 50 A (3-conductor terminal blocks)		

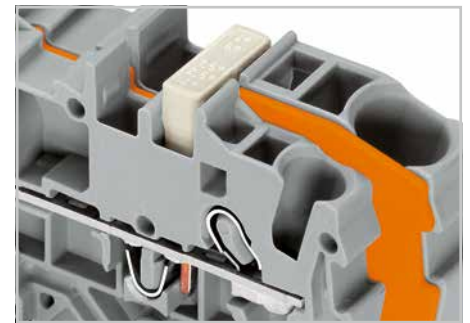

An end plate must be applied to the open side of the larger terminal block.

Additional terminal blocks having a smaller cross-section may be commoned using push-in type jumper bars.

Note:

The total current flowing shall not exceed the rating of the step-down jumper.

Cross-Section Reduction	Push-In Type Jumper Bar	Step-Down Jumper
16 to 10 mm ²	2010	
16 to 6 mm ²	2006	
16 to 4 mm ²		2016-499
16 to 2.5 mm ²		2016-499
10 to 6 mm ²	2006	
10 to 4 mm ²	2004	
10 to 2.5 mm ²		2016-499
6 to 4 mm ²	2004	
6 to 2.5 mm ²	2002	
6 to 1.5 mm ²		2006-499



Please find the entire product range in our Full Line Catalog. For additional information, visit www.wago.com.

TOPJOB® S

PUSH-IN CAGE CLAMP®





Through/Ground Conductor/Shield and Ex Terminal Blocks 16 (25 "f-st") mm²

2016 Series

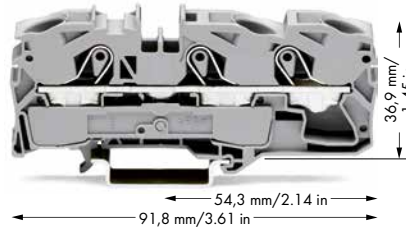
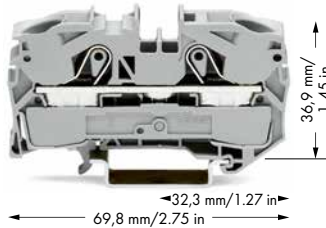
0.5 ... 16 (25 "f-st") mm ² ① 800 V/8 kV/3 I _N 76 A (90 A) Terminal block width: 12 mm / 0.472 in.  18 ... 20 mm / 0.75 in. ② Approvals	20 ... 4 AWG 600 V, 85 A ③ 600 V, 85 A ④	0.5 ... 16 (25 "f-st") mm ² ① 800 V/8 kV/3 I _N 76 A (90 A) Terminal block width: 12 mm / 0.472 in.  18 ... 20 mm / 0.75 in. ② Approvals	20 ... 4 AWG 600 V, 85 A ③ 600 V, 85 A ④	Step-down jumpers
--	--	--	--	-------------------













① Conductor range: 0.5 ... 16 mm² "st+f-st" and 25 mm² "f-st"
 Push-in termination: 2.5 ... 16 mm² "s" and 2.5 ... 16 mm² "insulated ferrule, 18 mm"



Color	Item No.	Pack. Unit	Color	Item No.	Pack. Unit	Item No.	Pack. Unit
2-conductor through terminal block			3-conductor through terminal block			Step-down jumper, insulated,	
gray ⑤	2016-1201	20	gray ⑤	2016-1301	20	I _N 32 A, light gray,	
blue ⑤	2016-1204 ③	20	blue ⑤	2016-1304 ③	20	commons 6/4 mm ² down to 4/2.5/1.5 mm ²	
orange ⑤	2016-1202	20	orange ⑤	2016-1302	20	2006-499	50 (2x25)
2-conductor ground terminal block			3-conductor ground terminal block			Step-down jumper, insulated,	
green-yellow ⑤	2016-1207	20	green-yellow ⑤	2016-1307	20	I _N 57 A, light gray,	
2-cond. shield conductor terminal block						commons 16/10 mm ² down to 10/6/4/2.5 mm ²	
white	2016-1208	20				2016-499	50 (2x25)
Item-Specific Accessories							
End and intermediate plate, 1 mm thick				End and intermediate plate, 1 mm thick			
	● 2016-1292	100 (4x25)		● 2016-1392	100 (4x25)		
	● 2016-1291	100 (4x25)		● 2016-1391	100 (4x25)		

Accessories, 2016 Series

Appropriate marking systems: **WMB/Marking Strips/WMB Inline/Miniature WSB**

Push-in type jumper bar, insulated, I _N 76 A, light gray 2-way 2016-402 50 (2x25) 3-way 2016-403 50 (2x25) 4-way 2016-404 50 (2x25) 5-way 2016-405 50 (2x25)	Push-in type jumper bar, insulated, I _N 76 A, light gray 1 to 3 2016-433 50 (2x25) 1 to 4 2016-434 50 (2x25) 1 to 5 2016-435 50 (2x25)
Star point jumper, insulated, I _N = I _N terminal block, light gray 1-3-5 2016-405/011-000 50 (2x25)	Finger guard, touch-proof cover protects unused conductor entries  ● 2016-100 100 (4x25)
Protective warning marker, with high-voltage symbol, for 5 terminal blocks  ● 2016-115 50 (2x25)	Operating tool, 3.5 mm and 5.5 mm blades  ● 2009-310 1
Test plug adapter, for 4 mm Ø test plug  ● 2009-174 100 (4x25) Testing tap, for max. 2.5 mm²  ● 2009-182 100 (4x25)	Operating tool with a partially insulated shaft, type 3, (5.5 x 0.8) mm blade  ● 210-721 1
Modular TOPJOB® S connector, can be snapped together, I_N 32 A, for jumper contact slot  ● 2016-511 100 (4x25)	Banana plugs, only for safety extra-low voltage (42 V)  ● 215-212 50  ● 215-311 50 For additional colors, see page 262.
Spacer module, can be snapped together  ● 2016-549 100 (4x25)	Marking strip, plain, 11 mm wide, 50 m roll  ○ 2009-110 1
Insulated ferrules, extra long, for TOPJOB® S terminal blocks, see page 259 	③ Suitable for Ex i applications ⑤ Suitable for Ex e II applications 550 V, 70 A (2-conductor terminal blocks) 550 V, 67 A (3-conductor terminal blocks)

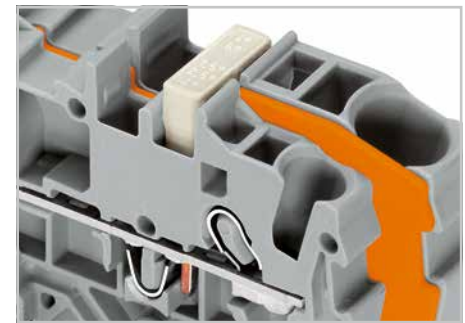

An end plate must be applied to the open side of the larger terminal block.

Additional terminal blocks having a smaller cross-section may be commoned using push-in type jumper bars.

Note:
The total current flowing shall not exceed the rating of the step-down jumper.

Cross-Section Reduction	Push-In Type Jumper Bar	Step-Down Jumper
16 to 10 mm ²	2010	
16 to 6 mm ²	2006	
16 to 4 mm ²		2016-499
16 to 2.5 mm ²		2016-499
10 to 6 mm ²	2006	
10 to 4 mm ²	2004	
10 to 2.5 mm ²		2016-499
6 to 4 mm ²	2004	
6 to 2.5 mm ²	2002	
6 to 1.5 mm ²		2006-499

② For all approvals and corresponding ratings, visit www.wago.com.

For technical information and abbreviations, see "Technical Section."

High-Current Terminal Blocks, 285 Series – Description and Installation –

POWER CAGE CLAMP

Conductor termination



Rotate the T-wrench or screwdriver counter-clockwise to the stop ①. Next, push in the orange locking tab. The clamp is locked open for hands-free wiring.



Insert stripped conductor into the clamping unit until it hits the backstop. Hold this position.



A short counter-clockwise rotation ② releases the tab. When unlocked, the T-wrench rotates clockwise, securely clamping the conductor.

Conductor preparation



1. Bend conductor, if required
2. Cut conductor to length (Conductor end must be straight!)
3. Strip conductor (Observe strip length printed on terminal block!)

Safety notes



Risk of injury!
Keep fingers out of the conductor entry hole!



Warning covers visually indicate high-voltage applications (e.g., NOTICE: Power is still on even after switching off the main switch!)

Finger guard



Touch-proof cover protects unused conductor entries and jumper slots (separate jumper entry protector from touch-proof cover).

Commoning (35 mm²)



Commoning adjacent terminal blocks using a centrally positioned push-in jumper.

Use an operating tool to remove the conductor!

Commoning (50 mm²/95 mm²/185 mm²)

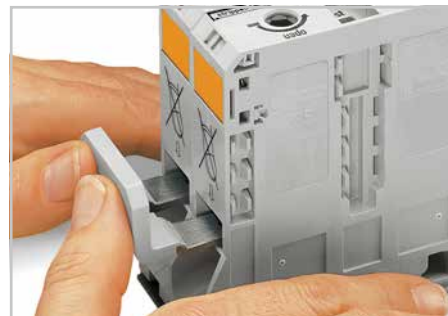

Commoning with adjacent jumper: tool-free insertion of jumper above the conductor entry. The nominal cross-section remains unchanged.

Testing

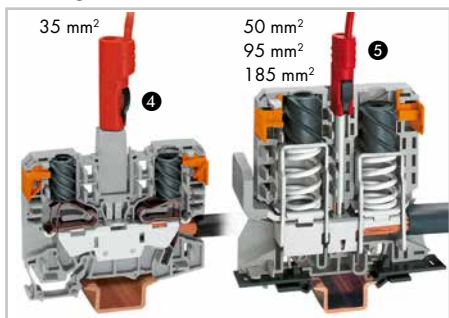

- ④ via test adapter for 4 mm Ø plugs
- ⑤ via touch-proof 4 mm Ø plugs

Power tap (35 mm²)



The power tap is inserted into the jumper contact slot. It can be fitted with a strain relief plate and provides a test option for 2 mm Ø test plugs.

Power tap (50 mm²/95 mm²/185 mm²)



Reliably and easily tap directly into the power supply. Insert the unwired tap before opening the clamping unit.









For information on POWER CAGE CLAMP connection, see page 15.

For aluminum conductors, see notes in Full Line Catalog.



High-Current, Through/Ground Conductor and Ex Terminal Blocks

35 mm², 50 mm² and 95 mm²

285 Series

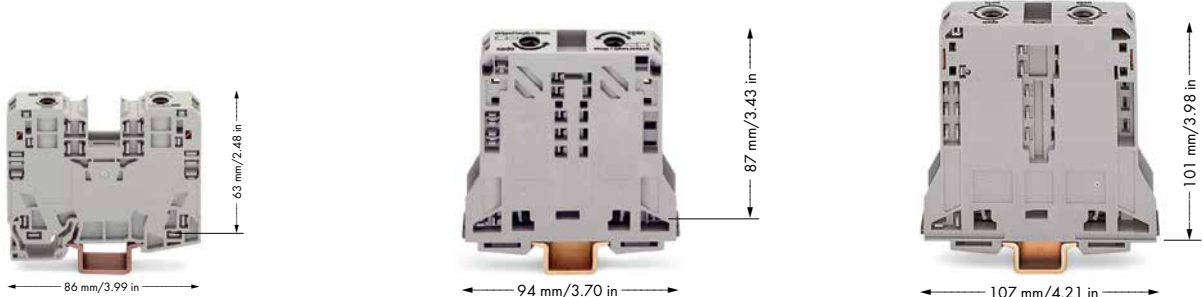





























<p>6 ... 35 mm² 1000 V/8 kV/3 I_N 125 A</p> <p>Terminal block width: 16 mm / 0.63 in.</p>  25 mm / 0.98 in. <p>② Approvals</p>	<p>8 ... 2 AWG 600 V, 115 A  600 V, 115 A </p>	<p>10 ... 50 (70 "f-st") mm² 1000 V/8 kV/3 I_N 150 A</p> <p>Terminal block width: 20 mm / 0.787 in.</p>  30 mm / 1.18 in. <p>② Approvals</p>	<p>8 ... 1 AWG 600 V, 150 A  600 V, 150 A </p>	<p>25 ... 95 mm² 1000 V/8 kV/3 I_N 232 A</p> <p>Terminal block width: 25 mm / 0.98 in.</p>  35 mm / 1.38 in. <p>② Approvals</p>	<p>4 ... 4/0 AWG 600 V, 200 A  600 V, 210 A </p>
--	--	--	--	---	--



Color	Item No.	Pack. Unit	Color	Item No.	Pack. Unit	Color	Item No.	Pack. Unit
2-conductor through terminal block			2-conductor through terminal block			2-conductor through terminal block		
gray	285-135	15	gray	285-150	5	gray	285-195	5
blue	285-134	15	blue	285-154	5	blue	285-194	5
light gray 	285-935	15	dark gray/yellow	285-151	5	light gray 	285-995	5
dark gray/yellow	285-131	15				dark gray/yellow	285-191	5
2-cond. ground conductor terminal block, only for DIN 35 x 15 rails; 2.3 mm thick, copper			2-cond. ground conductor terminal block, only for DIN 35 x 15 rails; 2.3 mm thick, copper			2-cond. ground conductor terminal block, only for DIN 35 x 15 rails; 2.3 mm thick, copper		
green-yellow	285-137	15	green-yellow	285-157	5	green-yellow	285-197	5
						green-yellow 	285-197/999-950	5

Accessories, 285 Series

Appropriate marking system: **WMB/WMB Inline**

<p>Adjacent jumper, insulated, I_N 85 A, gray  285-435 50 (2x25)</p>	<p>Adjacent jumper, insulated,  I_N 150 A for 1 jumper I_N 130 A for 2 to 4 jumpers  285-450 25</p>	<p>Adjacent jumper, insulated,  I_N 232 A for 1 jumper I_N 130 A for 2 to 4 jumpers  285-495 25</p>
<p>Power tap, I_N 32 A, 0.2 ... 6 mm², 8 mm/0.315 in. wide  285-427 5</p>	<p>Power tap, I_N 41 A, 0.2 ... 6 mm²,  16 mm/0.63 in. wide  285-447 5</p>	<p>Power tap, I_N 57 A, 0.2 ... 10/16 mm²,  20 mm/0.787 in. wide  285-407 5</p>
<p>Operating tool with a partially insulated shaft, type 3, (5.5 x 0.8) mm blade  210-721 1</p>	<p>Allen wrench with a partially insulated shaft 8 mm  285-172 1</p>	<p>Allen wrench with a partially insulated shaft 8 mm  285-172 1</p>
<p>Protective warning marker, with high-voltage symbol, black  285-420 50 (2x25)</p>	<p>Protective warning marker, with high-voltage symbol, black  285-440 50 (2x25)</p>	<p>Protective warning marker, with high-voltage symbol, black  285-170 50 (2x25)</p>
<p>Finger guard, touch-proof cover protects unused conductor entries  285-421 100 (4x25)</p>	<p>Finger guard, touch-proof cover protects unused conductor entries and jumper slots  285-441 100 (4x25)</p>	<p>Finger guard, touch-proof cover protects unused conductor entries and jumper slots  285-169 25</p>
<p>Step-down jumper, insulated, 800 V, I_N 32 A, gray  285-499 50 (2x25)</p>	<p>Test plug, 4 mm Ø, protected against accidental contact (e.g., available through Multi-Contact Deutschland GmbH Postfach 1606, 79551 Weil am Rhein, Hegenheimerstraße 19 79576 Weil am Rhein) </p>	<p>Test plug, 4 mm Ø, protected against accidental contact (e.g., available through Multi-Contact Deutschland GmbH Postfach 1606, 79551 Weil am Rhein, Hegenheimerstraße 19 79576 Weil am Rhein) </p>
<p>Steel carrier rail, per EN 60715, 35 x 15 mm, 1.5 mm thick, 2 m long, unslotted  210-114 10</p>	<p>Copper carrier rail, per EN 60715, 35 x 15 mm, 2.3 mm thick, 2 m long, unslotted  210-198 10</p>	<p>Copper carrier rail, per EN 60715, 35 x 15 mm, 2.3 mm thick, 2 m long, unslotted  210-198 10</p>
<p>Marking strip, plain, 11 mm wide, 50 m roll  2009-110 1</p>	<p>Block-to-block connector, for 50 mm² high-current terminal blocks  285-448 25 WMB</p>	<p>Block-to-block connector, for 95 mm² high-current terminal blocks  285-168 25</p>
<p>Test plug adapter, 11.6 mm wide, for 4 mm Ø test plug  283-404 25</p>	<p>Multi marking system, plain, 10 strips with 10 markers per card, stretchable from 5 ... 5.2 mm  793-5501 5</p>	<p> Suitable for Ex e II applications 25 ... 95 mm² 4 ... 4/0 AWG 750 V, 195 A 35 ... 70 mm² 2 ... 2/0 AWG for ground conductor terminal blocks</p>

② For all approvals and corresponding ratings, visit www.wago.com.

For technical information and abbreviations, see "Technical Section."

High-Current Through and Ground Conductor Terminal Blocks, 185 mm²

285 Series

50 ... 185 mm² | 1/0 AWG ... 350 kcmil
AC/DC 1000 V/DC 1500 V/12 kV/3 ①
I_N 353 A
Terminal block width: 32 mm / 1.26 in.
45 ... 47 mm / 1.77 ... 1.85 in.
② Approvals

50 ... 185 mm² | 1/0 AWG ... 350 kcmil
AC/DC 1000 V/DC 1500 V/12 kV/3 ①
I_N 353 A
Terminal block width: 32 mm / 1.26 in.
45 ... 47 mm / 1.77 ... 1.85 in.
② Approvals



① AC/DC up to 1000 V = Rated voltage
DC up to 1500 V
12 kV = Rated impulse voltage
3 = Pollution degree

(see Full Line Catalog)

Color	Item No.	Pack. Unit	Color	Item No.	Pack. Unit
2-conductor through terminal block only for DIN 35 x 15 rails			2-conductor through terminal block with screw flanges		
gray	285-1185	5	gray	285-1161	4
blue	285-1184	5	blue	285-1164	4
2-conductor ground terminal block, only for DIN 35 x 15 rails; 2.3 mm thick, copper			2-conductor through terminal block with screw flanges		
green-yellow	285-1187	5	dark gray/yellow	285-1167	4

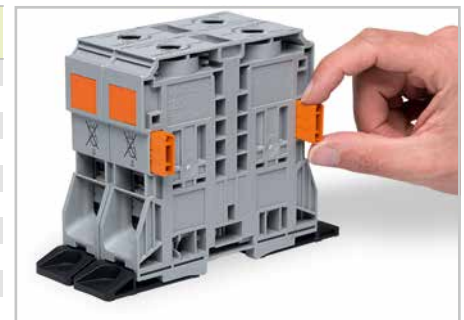













High-current through terminal blocks for M8 screws and fixing elements

Accessories, 285 Series

Appropriate marker systems:

WMB/Marking Strips/WMB Inline

Adjacent jumper, insulated, ③ I _N 309 A for 1 jumper		○ 285-1171	25	Block-to-block connector, for 185 mm ² high-current terminal blocks		○ 285-1179	25
Power tap, I_N 57 A, 0.2 ... 10/16 mm², ③ 20 mm/0.787 in. wide		○ 285-1175	5	WMB Inline, plain, stretchable from 5 ... 5.2 mm, 1,500 WMB markers (5 mm) per roll		○ 2009-115	1
Allen wrench with a partially insulated shaft 8 mm		285-172	1	Marking strip, plain, 11 mm wide, 50 m roll		○ 2009-110	1
Protective warning marker, with high-voltage symbol, black		● 285-1177	50 (2x25)	WMB Multi marking system, plain, 10 strips with 10 markers per card, for 5 ... 17.5 mm terminal block width		○ 793-501	5
Finger guard, touch-proof cover protects unused conductor entries and jumper slots		● 285-1178	25	WMB Multi marking system, plain, 10 strips with 10 markers per card, stretchable from 5 ... 5.2 mm		○ 793-5501	5
Copper carrier rail, as per EN 60715, 35 x 15 mm, 2.3 mm thick, 2 m long unslotted		210-198	10				
Three-phase set, with 185 mm ² high-current terminal blocks		285-1169	1				
Screwless end stop, for DIN-35 rail, 14 mm wide		○ 249-197	10				

Marking

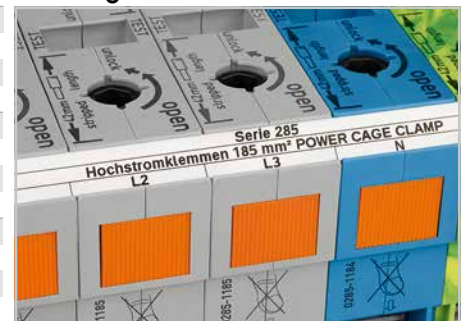

In addition to WMB markers, marking strips can be directly applied to 185 mm² (350 kcmil) high-current terminal blocks.

834 Series



Commoning from 35 mm²/AWG 2 POWER CAGE CLAMP terminal blocks to 10/16 mm² (AWG 8/10) TOPJOB® S terminal blocks (2010 and 2016 Series)

③ Adjacent jumpers and power taps can only be removed or inserted when the clamp is in closed position.

TOPJOB® S

Double-Deck Terminal Blocks 1 (1.5) mm²

2000 Series

<p>0.14 ... 1 (1.5) mm² ① 24 ... 16 AWG 500 V/6 kV/3 I_N 13.5 A (16 A)</p> <p>Terminal block width: 3.5 mm / 0.138 in. 9 ... 11 mm / 0.39 in.</p> <p>② Approvals</p>	<p>0.14 ... 1 (1.5) mm² ① 24 ... 16 AWG 500 V/6 kV/3 I_N 13.5 A (16 A)</p> <p>Terminal block width: 3.5 mm / 0.138 in. 9 ... 11 mm / 0.39 in.</p> <p>② Approvals</p>	<p>0.14 ... 1 (1.5) mm² ① 24 ... 16 AWG 800 V/8 kV/3 I_N 13.5 A (16 A)</p> <p>Terminal block width: 4.2 mm / 0.165 in. 9 ... 11 mm / 0.39 in.</p> <p>② Approvals</p>
---	---	---

① Conductor range: 0.14 ... 1.5 mm² "s+f-st"
Push-in termination: 0.5 ... 1.5 mm² "s" and 0.5 ... 0.75 mm² "insulated ferrule, 10 mm"

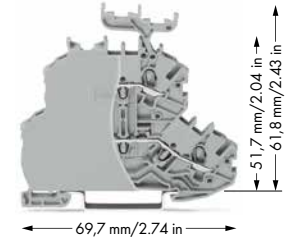
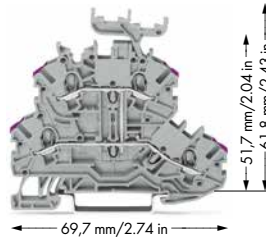
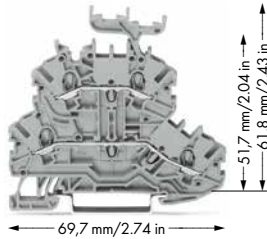
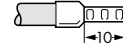

Color	Item No.	Item No.	Pack. Unit	Color	Item No.	Item No.	Pack. Unit	Color	Item No.	Item No.	Pack. Unit
Through/through terminal block, gray housing				4-conductor through terminal block, internally commoned, gray housing, violet-colored conductor entry				Through/through terminal block, with end plate, gray housing			
Marker carrier with		without		Marker carrier with		without		Marker carrier with		without	
● L/L	2000-2231	2000-2201	50	● L	2000-2238	2000-2208	50	● L/L	2000-2231/099-000	2000-2201/099-000	50
● N/L	2000-2232	2000-2202	50					● N/L	2000-2232/099-000	2000-2202/099-000	50
● L/N	2000-2233	2000-2203	50					● L/N	2000-2233/099-000	2000-2203/099-000	50
Blue housing				4-conductor through terminal block, internally commoned, blue housing, violet-colored conductor entry				Blue housing			
● N/N	2000-2234 ③	2000-2204 ③	50	● N	2000-2239 ③	2000-2209 ③	50	● N/N	2000-2234/099-000 ③	2000-2204/099-000 ③	50

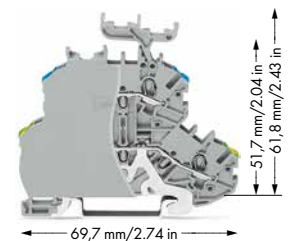
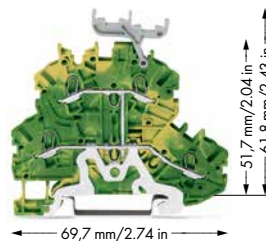
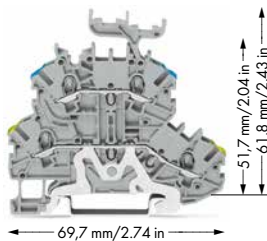

Color	Item No.	Item No.	Pack. Unit	Color	Item No.	Item No.	Pack. Unit	Color	Item No.	Item No.	Pack. Unit
Ground conductor/through terminal block, colored conductor entry				4-conductor ground terminal block, internally commoned, green-yellow housing				Ground conductor/through terminal block, with end plate, colored conductor entry			
Marker carrier with		without		Marker carrier with		without		Marker carrier with		without	
● PE/N	2000-2247	2000-2217	50	● PE	2000-2237	2000-2207	50	● PE/N	2000-2247/099-000	2000-2217/099-000	50
● PE/L	2000-2257	2000-2227	50					● PE/L	2000-2257/099-000	2000-2227/099-000	50
Shield conductor/through terminal block, colored conductor entry								Shield conductor/through terminal block, with end plate, colored conductor entry			
Marker carrier with		without		Marker carrier with		without		Marker carrier with		without	
● Shield/N	2000-2248	2000-2218	50					● Shield/N	2000-2248/099-000	2000-2218/099-000	50
● Shield/L	2000-2258	2000-2228	50					● Shield/L	2000-2258/099-000	2000-2228/099-000	50

Item-Specific Accessories

<p>End and intermediate plate, 0.7 mm thick</p> <p>● 2000-2292 100 (4x25)</p> <p>○ 2000-2291 100 (4x25)</p>	<p>End and intermediate plate, 0.7 mm thick</p> <p>● 2000-2292 100 (4x25)</p> <p>○ 2000-2291 100 (4x25)</p>	<p>The end plate is an integral part of the terminal block.</p>
--	--	---

Accessories, 2000 Series

Appropriate marking systems: **WMB/Marking Strips/WMB Inline**

<p>Push-in type jumper bar, insulated, I_N 14 A, light gray</p> <p>2-way 2000-402 200 (8x25)</p> <p>3-way 2000-403 200 (8x25)</p> <p>4-way 2000-404 200 (8x25)</p> <p>10-way 2000-410 100 (4x25)</p> <p>● .../000-005 ● .../000-006</p>	<p>Push-in type jumper bar, insulated, I_N 25 A, light gray</p> <p>1 to 3 2000-433 200 (8x25)</p> <p>1 to 10 2000-440 100 (4x25)</p> <p>Double-deck vertical jumper, insulated, I_N 13.5 A</p> <p>○ 2000-492</p> <p>● 2000-493/000-012 100 (4x25)</p>	<p>Star point jumper, insulated, I_N = I_N terminal block, light gray</p> <p>1-3-5 2000-405/011-000 100 (4x25)</p> <p>Double-deck marker carrier, pivoting</p> <p>○ 2000-121 50 (2x25)</p>
--	---	--

Please find the entire product range in our Full Line Catalog. For additional information, visit www.wago.com.

TOPJOB® S

Double-Deck Terminal Blocks 2.5 (4) mm²

2002 Series

PUSH-IN CAGE CLAMP®

0.25 ... 2.5 (4) mm² ① 22 ... 12 AWG
 500 V/6 kV/3 I_N 24 A (28 A)
 300 V, 20 A ②
 600 V, 20 A ③

Terminal block width: 5.2 mm / 0.205 in.
 10 ... 12 mm / 0.43 in.

② Approvals

① Conductor range: 0.25 ... 4 mm² "st+st"
 Push-in termination: 0.75 ... 4 mm² "s" and
 0.75 ... 2.5 mm² "insulated ferrule, 12 mm"

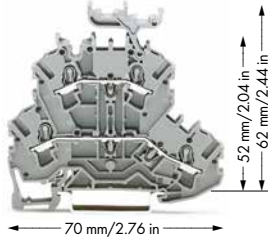

0.25 ... 2.5 (4) mm² ① 22 ... 12 AWG
 800 V/8 kV/3 I_N 24 A (28 A)

Terminal block width: 5.2 mm / 0.205 in.
 10 ... 12 mm / 0.43 in.

② Approvals

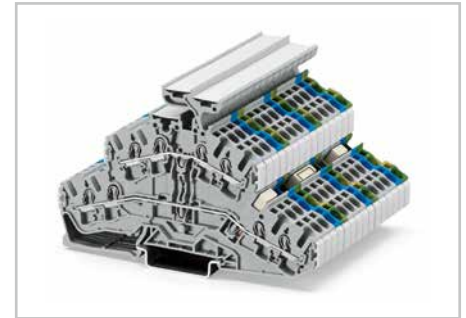
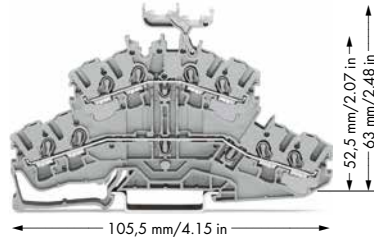

Color	Item No.	Item No.	Pack. Unit	Color	Item No.	Item No.	Pack. Unit
2-conductor double-deck terminal block, for DIN-35 rail Through/through terminal block,				4-conductor double-deck terminal block, for DIN-35 rail Through/through terminal block,			
Marker carrier with		without		Marker carrier with		without	
○ L/L ②	2002-2231	2002-2201	50	○ L/L ②	2002-2431	2002-2401	50
○ N/L ②	2002-2232	2002-2202	50	○ N/L ②	2002-2432	2002-2402	50
○ L/N ②	2002-2233	2002-2203	50	○ L/N ②	2002-2433	2002-2403	50
Blue housing				Blue housing			
● N/N	2002-2234 ③	2002-2204 ③	50	● N/N	2002-2434 ③	2002-2404 ③	50
Ground conductor/through terminal block,				Ground conductor/through terminal block,			
○ PE/N ②	2002-2247	2002-2217	50	○ PE/N ②	2002-2447	2002-2417	50
○ PE/L ②	2002-2257	2002-2227	50	○ PE/L ②	2002-2457	2002-2427	50

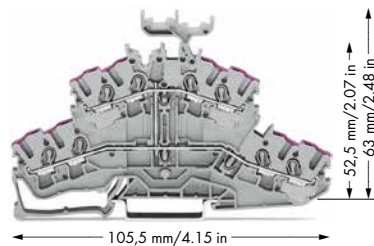
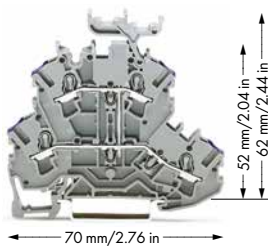

Color	Item No.	Item No.	Pack. Unit	Color	Item No.	Item No.	Pack. Unit
4-conductor double-deck terminal block, for DIN-35 rail Through terminal block, internally commoned, violet-colored conductor entry				8-conductor double-deck terminal block, for DIN-35 rail Through terminal block, internally commoned, violet-colored conductor entry			
Marker carrier with		without		Marker carrier with		without	
○ L ②	2002-2238	2002-2208	50	○ L ②	2002-2438	2002-2408	50
4-conductor through terminal block, internally commoned, violet-colored conductor entry				Through terminal block, internally commoned, violet-colored conductor entry			
● N	2002-2239 ③	2002-2209 ③	50	● N	2002-2439 ③	2002-2409 ③	50
4-conductor double-deck terminal block, for DIN-35 rail Ground terminal block, internally commoned,				4-conductor double-deck terminal block, for DIN-35 rail Ground terminal block, internally commoned,			
● PE ②	2002-2237	2002-2207	50	● PE ②	2002-2437	2002-2407	50

Item-Specific Accessories

Appropriate marking systems: **WMB/Marking Strips**

End and intermediate plate, 0.8 mm thick

●	2002-2292	100 (4x25)
○	2002-2291	100 (4x25)

End and intermediate plate, 0.8 mm thick

●	2002-2492	100 (4x25)
○	2002-2491	100 (4x25)

Accessories, 2002 Series

Adjacent jumper for continuous commoning, insulated, I_N 25 A, light gray

2-way	2002-400	100 (4x25)
1 to 3	2002-423	100 (4x25)

Push-in type jumper bar, insulated, I_N 25 A, light gray

2-way	2002-402	200 (8x25)
3-way	2002-403	200 (8x25)
4-way	2002-404	200 (8x25)
:	:	:
10-way	2002-410	100 (4x25)

● .../000-005 ● .../000-006

Push-in type jumper bar, insulated, I_N 25 A, light gray

1 to 3	2002-433	200 (8x25)
1 to 4	2002-434	200 (8x25)
:	:	:
1 to 10	2002-440	100 (4x25)

Staggered jumper, insulated, I_N 25 A, light gray

2-way	2002-472	100 (4x25)
3-way	2002-473	100 (4x25)
:	:	:
12-way	2002-482	50 (2x25)

Double-deck vertical jumper, insulated, I_N 24 A

○	2002-492	
●	2002-492/000-012	100 (4x25)

Modular TOPJOB® S connector,
 can be snapped together, for jumper contact slot, I_N 24 A

○	2002-511	100 (4x25)
---	----------	------------

Spacer module, can be snapped together

○	2002-549	100 (4x25)
---	----------	------------

Protective warning marker, with high-voltage symbol, for 5 terminal blocks

●	2002-115	100 (4x25)
---	----------	------------

Double-deck marker carrier, pivoting

○	2002-121	50 (2x25)
---	----------	-----------

Operating tool with a partially insulated shaft, type 2, (3.5 x 0.5) mm blade

210-720	1
---------	---

③ Suitable for Ex i applications
 ② Suitable for Ex e II applications
 440 V, 20 A



② For all approvals and corresponding ratings, visit www.wago.com.

For technical information and abbreviations, see technical section.

TOPJOB® S

Triple-Deck Terminal Blocks 2.5 (4) mm²

2002 Series

0.25 ... 2.5 (4) mm ² ① 500 V/6 kV/3 I _N 24 A (28 A) Terminal block width: 5.2 mm / 0.205 in.  10 ... 12 mm / 0.43 in.	22 ... 12 AWG 300 V, 20 A ② 600 V, 20 A ③	0.25 ... 2.5 (4) mm ² ① 500 V/6 kV/3 I _N 24 A (28 A) Terminal block width: 5.2 mm / 0.205 in.  10 ... 12 mm / 0.43 in.	22 ... 12 AWG
---	---	---	---------------

② Approvals

① Conductor range: 0.25 ... 4 mm² "s+fst"
 Push-in termination: 0.75 ... 4 mm² "s" and
 0.75 ... 2.5 mm² "insulated ferrule, 12 mm"

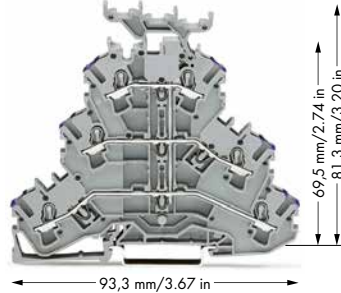
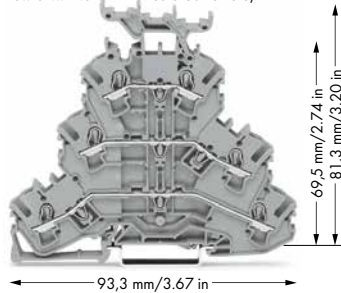



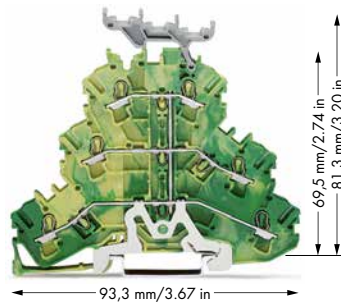
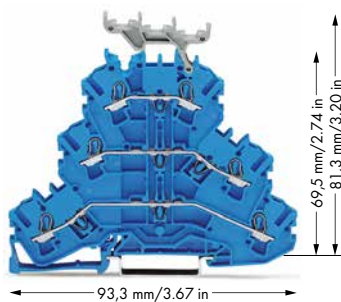







Color	Item No.	Item No.	Pack. Unit	Color	Item No.	Item No.	Pack. Unit
Through/through/through terminal block				6-conductor through terminal block, internally commoned, violet-colored conductor entry			
Marker carrier with without				Marker carrier with without			
● L/L/L	2002-3231	2002-3201	50	● L	2002-3238	2002-3208	50
● L/L/N	2002-3233	2002-3203	50				
Ground conductor/through/through terminal block				Shield/through/through terminal block			
Marker carrier with without				Marker carrier with without			
● PE/N/L	2002-3247	2002-3217	50	● Shield/N/L	2002-3248	2002-3218	50
● PE/L/L	2002-3257	2002-3227	50	● Shield/L/L	2002-3258	2002-3228	50



Color	Item No.	Item No.	Pack. Unit	Color	Item No.	Item No.	Pack. Unit
Through/through/through terminal block				6-conductor ground terminal block, internally commoned,			
Marker carrier with without				Marker carrier with without			
● N/N/N	2002-3234 ③	2002-3204 ③	50	● PE	2002-3237	2002-3207	50
6-conductor through terminal block							
Marker carrier with without							
● N	2002-3239 ③	2002-3209 ③	50				

Accessories, 2002 Series

End and intermediate plate, 0.8 mm thick			
	●	2002-3292	100 (4x25)
	○	2002-3291	100 (4x25)
Triple-deck marker carrier, pivoting			
	○	2002-131	50 (2x25)
Adjacent jumper for continuous commoning, insulated, I _N 25 A, light gray			
		2-way	2002-400 100 (4x25)
		1 to 3	2002-423 100 (4x25)
Push-in type jumper bar, insulated, I _N 25 A, light gray			
		2-way	2002-402 200 (8x25)
		3-way	2002-403 200 (8x25)
		4-way	2002-404 200 (8x25)
		:	:
		10-way	2002-410 100 (4x25)
● .../000-005	●	.../000-006	
Push-in type jumper bar, insulated, I _N 25 A, light gray			
		1 to 3	2002-433 200 (8x25)
		1 to 4	2002-434 200 (8x25)
		:	:
		1 to 10	2002-440 100 (4x25)
Staggered jumper, insulated, I _N 25 A, light gray			
		2-way	2002-472 100 (4x25)
		3-way	2002-473 100 (4x25)
		4-way	2002-474 100 (4x25)
		5-way	2002-475 50 (2x25)
		:	:
		12-way	2002-482 50 (2x25)
Double-deck vertical jumper, insulated, I_N 24 A			
	○	2002-492	
	●	2002-492/000-012	100 (4x25)
Triple-deck vertical jumper, insulated, I_N 25 A			
	○	2002-493	
	●	2002-493/000-012	100 (4x25)
Operating tool with a partially insulated shaft, type 2, (3.5 x 0.5) mm blade			
		210-720	1

TOPJOB® S

Quadruple-Deck Terminal Blocks 2.5 (4) mm²

2002 Series

PUSH-IN CAGE CLAMP®

1

0.25 ... 2.5 (4) mm ² ①	22 ... 12 AWG
800 V/8 kV/3	
I _N 20 A (25 A)	
Terminal block width: 5.2 mm / 0.205 in.	
10 ... 12 mm / 0.43 in.	
② Approvals	

① Conductor range: 0.25 ... 4 mm² "s+fst"
 Push-in termination: 0.75 ... 4 mm² "s" and 0.75 ... 2.5 mm² "insulated ferrule, 12 mm"

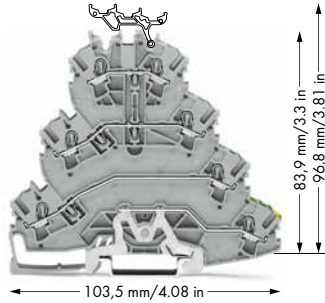

Creating spacer housings for rail-mounted terminal blocks for electric motor wiring via conductor entry and operating slot covers.

Color	Item No.	Pack. Unit
Quadruple-deck terminal block		
or		
Terminal block for electric motor wiring, with marker carrier, gray		
● L1 - L2	2002-4141	25
● L1 - L2 - L3	2002-4131	25
● L1 - L2 - L3 - PE	2002-4157	25

Accessories, 2002 Series	
End and intermediate plate, 0.8 mm thick	
●	2002-4192 100 (4x25)
○	2002-4191 100 (4x25)
Insulation stop, 5 pcs/strip	
○	2002-171 0.25-0.5 mm ²
●	2002-172 0.75-1 mm ²
200 (8x25)	
Star point jumper, insulated,	
I _N = I _N terminal block, light gray	
1 - 3 - 5	2002-405/011-000
100 (4x25)	
Delta jumper, insulated,	
I _N = I _N terminal block, light gray	
1-2 3-4 5-6	2002-406/020-000
100 (4x25)	



Compact design: Three phases and one ground conductor in a single terminal block.

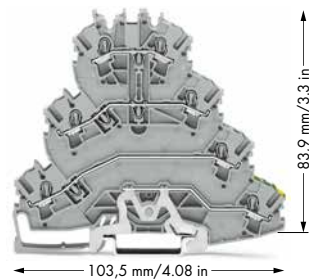

Color	Item No.	Pack. Unit
Quadruple-deck terminal block		
or		
Terminal block for electric motor wiring, without marker carrier, gray		
● L1 - L2	2002-4111	25
● L1 - L2 - L3	2002-4101	25
● L1 - L2 - L3 - PE	2002-4127	25

Push-in type wire jumper, insulated,	
I _N 18 A,	
1.5 mm ² conductor size	
L=60 mm	2009-412 100 (10x10)
L=110 mm	2009-414 100 (10x10)
L=250 mm	2009-416 100 (10x10)
Lockout cap,	
for conductor entry and operating slot	
●	2002-192 25
○	2002-191 25
●	2002-194 25
Protective warning marker, with high-voltage symbol, for 5 terminal blocks	
●	2002-115 100 (4x25)
WMB Inline, plain, stretchable from 5 ... 5.2 mm, 1,500 WMB markers (5 mm) per roll	
○	2009-115 1
Marking strip, plain,	
11 mm wide,	
50 m roll	
○	2009-110 1
Modular TOPJOB® S L-test plug, can be snapped together,	
I _N 18 A, for conductor entry	
●	2002-611 100 (4x25)
Spacer module, can be snapped together	
●	2002-649 100 (4x25)



Marking clamping units with WMB Multi marking system (see Full Line Catalog). Group marking via marking strips.



Testing with 2 mm Ø test plug.

② For all approvals and corresponding ratings, visit www.wago.com.

For technical information and abbreviations, see technical section.

TOPJOB® S Multilevel Installation Terminal Blocks, N-Disconnect Slide Link and Busbar Carrier – Description and Installation –

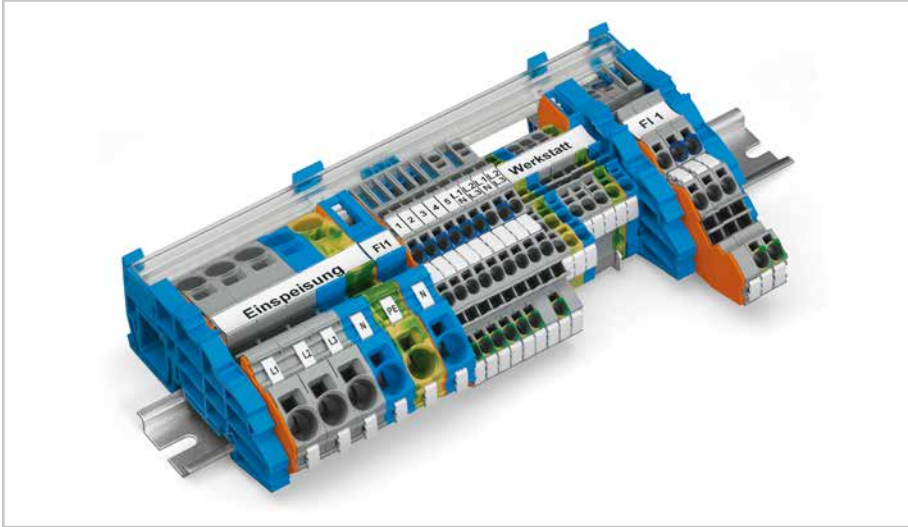

TOPJOB® S – Terminal Blocks for Every Application

- Push-in termination of solid conductors in small distribution boards saves time and money.
- Operating errors can be prevented as all TOPJOB® S terminal blocks for building installations are equipped with push-in connection technology.
- Terminal blocks for building installations expand circuit design possibilities.
- The use of standard accessories reduces order processing and inventory costs.
- Accessories, shared with all terminal blocks, enhance safety by reducing the amount of components and installation techniques required.
- The busbar position is the same, making the TOPJOB® S Terminal Blocks compatible with standard TOPJOB® Installation Terminal Blocks.
- The optional busbar transparent cover (Item No. 777-303) protects the busbar against accidental contact and makes it easy to see which terminal blocks are connected to the busbar.

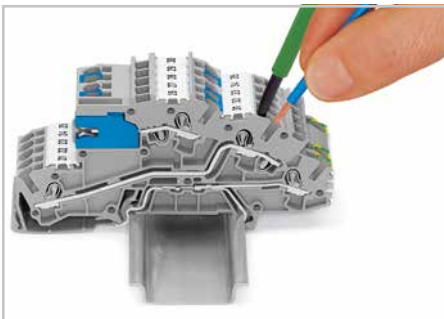

Terminating fine-stranded conductors using an operating tool.

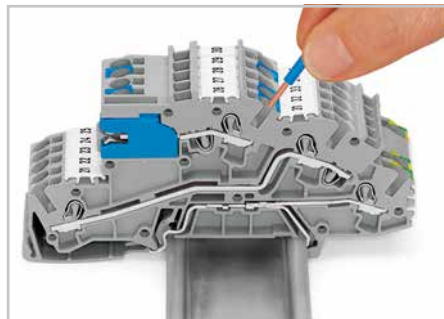

Terminating solid conductors by simply pushing them in.



Conductor entries on multilevel installation terminal blocks are color-coded, providing a clear arrangement of the terminals.



Testing with 2 mm Ø test plug (max. test voltage: 42 V).



Tool-operated N-disconnect slide link

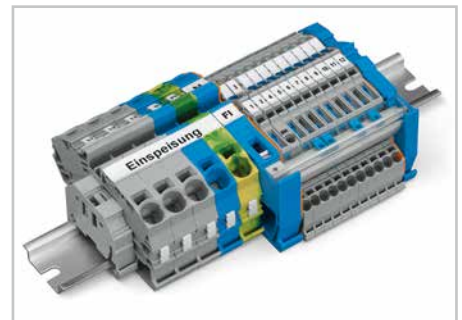

Each connection point features an individual marker slot for WMB markers. Additionally, the upper marker slot is suitable for marker strips that can be marked manually using a felt-tip pen or automatically via thermal transfer printer.

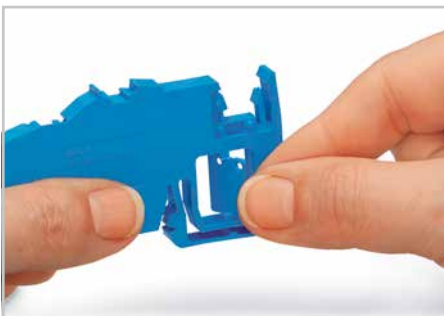

Removing the separator plate from the busbar carrier.

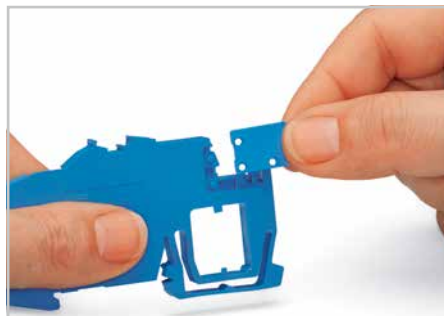

Inserting the separator plate to protect the N-busbar against accidental contact.

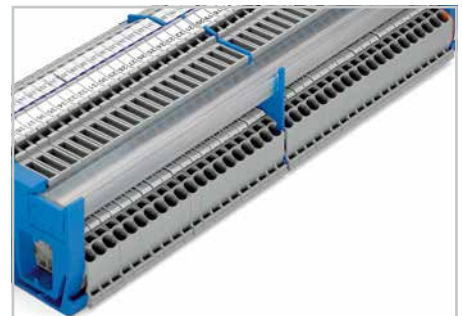

The compact busbar carrier, which is placed every 200 mm, provides additional busbar support for longer assemblies.

For information on Push-in CAGE CLAMP® connection, see page 14.

TOPJOB® S**Multilevel Installation Terminal Blocks****with N-Disconnect Slide Links 2.5 (4) / 4 (6) mm², 2003 / 2005 Series****PUSH-IN CAGE CLAMP®**

0.25 ... 2.5 (4) mm ² ① 250 V/4 kV/3; 32 A (32 A) ③ ④ 400 V/6 kV/3; 32 A (32 A) ③ ⑤ Terminal block width: 5.2 mm / 0.205 in. 10 ... 12 mm / 0.43 in. ⑥ Approvals	22 ... 12 AWG	0.5 ... 4 (6) mm ² ② 250 V/4 kV/3; 36 A (36 A) ③ ④ 400 V/6 kV/3; 36 A (36 A) ③ ⑤ Terminal block width: 6.2 mm / 0.244 in. 11 ... 13 mm / 0.47 in. ⑥ Approvals	20 ... 10 AWG
--	---------------	---	---------------

- ① Conductor range: 0.25 ... 4 mm² "s+f-st"
Push-in termination: 0.75 ... 4 mm² "s"
"insulated ferrules, 12 mm"
- ② Conductor range: 0.5 ... 6 mm² "s+f-st"
Push-in termination: 1 ... 6 mm² "s"
and 0.75 ... 4 mm²
"insulated ferrules, 12 mm"
- ③ 250 V/
400 V = Rated voltage
4 kV/
6 kV = Rated impulse voltage
3 = Pollution degree

- ④ 250 V/4 kV potential - ground
⑤ 400 V/6 kV potential - potential

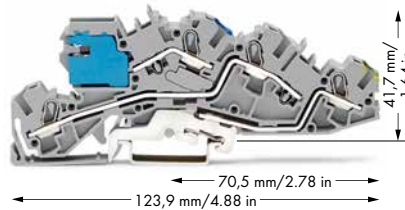
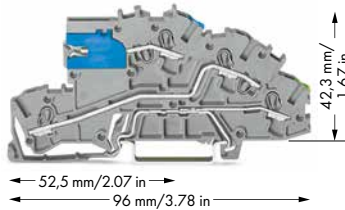

Color	Item No.	Pack. Unit	Color	Item No.	Pack. Unit	Accessories, 2003 and 2005 Series
Multilevel installation terminal block, with N-disconnect slide link			Multilevel installation terminal block, with N-disconnect slide link			Straight busbar, Cu with tin plating, 10 x 3 mm, 1000 mm long I _N 140 A 210-133 1
○ NT/L/PE	2003-7641	50	○ NT/L/PE	2005-7641	50	
○ NT/L	2003-7640	50				Cover for N-busbar, transparent, 1000 mm long 777-303 1
○ LT/L	2003-7659	50				N-supply terminal block, I _N 76 A, 16 mm ² , 12 mm wide 2016-7714 20
○ N/L/PE	2003-7646	50				
○ L/L/PE	2003-7645	50				Ground supply terminal block, 16 mm ² , 12 mm wide 2016-7607 20

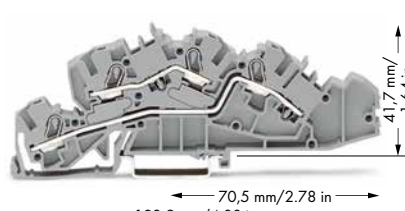
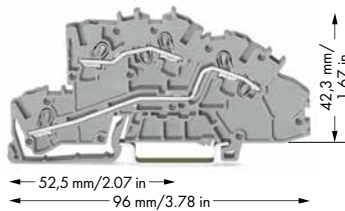

Color	Item No.	Pack. Unit	Color	Item No.	Pack. Unit	Accessories, 2003 and 2005 Series
Multilevel installation terminal block			Multilevel installation terminal block			Connector, with blue cover, for N-busbar, 2.5 ... 16 mm ² 210-281 100 (2x50)
○ L/L	2003-7642	50	○ N/L/PE	2005-7646	50	
○ N/L	2003-7649	50	○ L/L/PE	2005-7645	50	Connector, for N-busbar, 2.5 ... 35 mm ² unplated 209-105 50
○ L	2003-7650	50	○ L/L	2005-7642	50	
○ N	2003-7651	50	○ N/L	2005-7649	50	Test plug adapter, for 4 mm Ø test plug 209-174 100 (4x25)

Item-Specific Accessories

Appropriate marking systems:

WMB/Marking Strips/WMB Inline

End and intermediate plate, 0.8 mm thick 2003-7692 100 (4x25)	End and intermediate plate, 1 mm thick 2005-7692 100 (4x25)
Adjacent jumper for continuous commoning, insulated, I _N 25 A, light gray 2-way 2002-400 100 (4x25) 1 to 3 2002-423 100 (4x25)	
Push-in type jumper bar, insulated, I _N 25 A, light gray see page 27 (2002 Series)	Push-in type jumper bar, insulated, I _N 32 A, light gray see page 29 (2004 Series)
Lock-out, snap-on type, prevents reclosing of slide link 2003-7300 100 (4x25)	Lock-out, snap-on type, prevents reclosing of slide link 2005-7300 100 (4x25)
Staggered jumper, insulated, I _N 25 A, light gray 2-way 2002-472 100 (4x25) 3-way 2002-473 100 (4x25) : : 12-way 2002-482 50 (2x25)	

Test plug, with 500 mm cable 2 mm Ø 210-136 50 2.3 mm Ø 210-137 50
--

Operating tool, 3.5 mm and 2.5 mm blades 2009-309 1

Busbar carrier, not suitable as end stop, can be snapped onto DIN-35 rail, 1.5 mm thick 2009-304 100 (4x25)

Busbar carrier, with end stop function and detachable separator plate, can be snapped onto DIN-35 rail, 7.5 mm thick 2009-305 25
--

⑥ For all approvals and corresponding ratings, visit www.wago.com.

TOPJOB® S

N-Conductor and Power Distribution Disconnect Terminal Blocks

2002 / 2006 / 2016 Series

<p>0.25 ... 2.5 (4) mm² ① 22 ... 12 AWG 250 V/4 kV/3 I_N 32 A Terminal block width: 5.2 mm / 0.205 in. 10 ... 12 mm / 0.43 in. ④ Approvals</p>	<p>0.5 ... 6 (10) mm² ② 20 ... 8 AWG 250 V/4 kV/3 I_N 51 A Terminal block width: 7.5 mm / 0.295 in. 13 ... 15 mm / 0.55 in. ④ Approvals</p>	<p>0.5 ... 16 (25 "f-st") mm² ③ 20 ... 4 AWG 250 V/4 kV/3 I_N 76 A Terminal block width: 12 mm / 0.472 in. 18 ... 20 mm / 0.75 in. ④ Approvals</p>
---	--	---

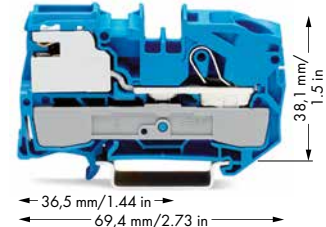
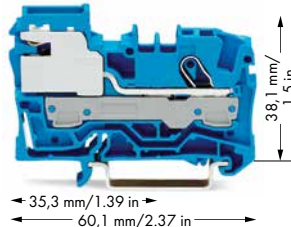
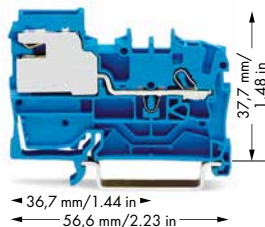

Color	Item No.	Pack. Unit	Color	Item No.	Pack. Unit	Color	Item No.	Pack. Unit
● blue	2002-7114	50	● blue	2006-7114	50	● blue	2016-7114	25
○ gray			○ gray			○ gray		
1-conductor N-disconnect terminal block			1-conductor N-disconnect terminal block			1-conductor N-disconnect terminal block		
1-conductor power distribution disconnect terminal block			1-conductor power distribution disconnect terminal block			1-conductor power distribution disconnect terminal block		
For compatible through/ground conductor terminal blocks and jumpers, see page 27.			For compatible through/ground conductor terminal blocks and jumpers, see page 30.			For compatible through/ground conductor terminal blocks and jumpers, see page 32.		

Item-Specific Accessories		Item-Specific Accessories		Item-Specific Accessories	
End and intermediate plate, 0.8 mm thick	● 2002-7192 100(4x25)	End and intermediate plate, 1 mm thick	● 2006-7192 100 (4x25)	End and intermediate plate, 1 mm thick	● 2016-7192 100 (4x25)
Lock-out, snap-on type, prevents reclosing of slide link	● 2003-7300 100(4x25)	Lock-out, snap-on type, prevents reclosing of slide link	● 2006-7300 100 (4x25)	Lock-out, snap-on type, prevents reclosing of slide link	● 2006-7300 100 (4x25)

Accessories, 2002, 2006 and 2016 Series

Appropriate marking systems: WMB/Marking Strips/WMB Inline

	<p>Busbar carrier, not suitable as an end stop, can be snapped onto DIN-35 rail, 1.5 mm thick ● 2009-304 100 (4x25)</p>	<p>Connector, for N-busbar, 2.5 ... 35 mm² unplated ● 209-105 50</p>
	<p>Busbar carrier, with end stop function and detachable separator plate, can be snapped onto DIN-35 rail, 7.5 mm thick ● 2009-305 25</p>	<p>Connector, with blue cover, for N-busbar, 2.5 ... 16 mm² ● 210-281 100 (2x50)</p>
<p>Straight busbar, Cu with tin plating, 10 x 3 mm, 1000 mm long I_N 140 A ● 210-133 1</p>	<p>Test plug, with 500 mm cable ● 2 mm Ø 210-136 50 ● 2.3 mm Ø 210-137 50</p>	
<p>Cover for N-busbar, transparent, 1000 mm long ● 777-303 1</p>	<p>WMB Multi marking system, plain, 10 strips with 10 markers per card, stretchable from 5 ... 5.2 mm ○ 793-5501 5</p>	
<p>Item-Specific Accessories</p> <p>End and intermediate plate, 0.8 mm thick ● 2002-7292 100 (4x25)</p>	<p>Operating tool, 3.5 mm and 5.5 mm blades ● 2009-310 1</p>	

④ For all approvals and corresponding ratings, visit www.wago.com.

TOPJOB® S

Supply Terminal Blocks for Distribution Cabinets,
N-Conductor and Power Distribution Disconnect Terminal Blocks, 2016 Series

0.5 ... 16 (25 "f-st") mm² ③ | 20 ... 4 AWG
250 V/4 kV/3
I_N 76 A
Terminal block width: 12 mm / 0.472 in.
18 ... 20 mm / 0.75 in.
④ Approvals

0.5 ... 16 (25 "f-st") mm² ③ | 20 ... 4 AWG
800 V/8 kV/3
I_N 76 A
Terminal block width: 12 mm / 0.472 in.
18 ... 20 mm / 0.75 in.
④ Approvals

- ① Conductor range: 0.25 ... 4 mm² "s+f-st"
Push-in termination: 0.75 ... 4 mm² "s"
and 0.75 ... 2.5 mm²
"insulated ferrules, 12 mm"
- ② Conductor range: 0.5 ... 10 mm² "s+f-st"
Push-in termination: 1.5 ... 10 mm² "s"
and 1.5 ... 6 mm²
"insulated ferrules, 12 mm"
- ③ Conductor range: 0.5 ... 16 mm² "s+f-st"
and 25 mm² "f-st"
Push-in termination: 2.5 ... 16 mm² "s"
and 2.5 ... 16 mm²
"insulated ferrules, 18 mm"

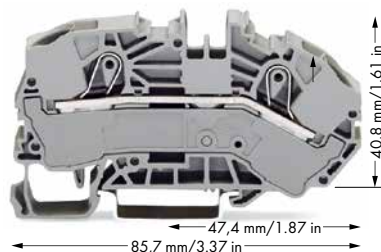
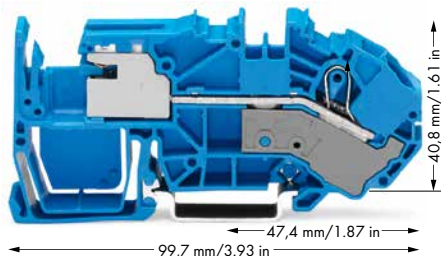

Color	Item No.	Pack. Unit	Color	Item No.	Pack. Unit
1-conductor N-disconnect terminal block			2-conductor supply terminal blocks for distribution cabinets		
● blue	2016-7714	20	● gray	2016-7601	20
			● blue	2016-7604	20
1-conductor power distribution disconnect terminal block			2-conductor ground conductor terminal block, 15 mm-high DIN-35 rails shall be used for a current load higher than 76 A.		
● gray	2016-7711	20	● green-yellow	2016-7607	20

Item-Specific Accessories

End and intermediate plate, 1 mm thick

● 2016-7792 100 (4x25)



Item-Specific Accessories

End and intermediate plate, 1 mm thick

● 2016-7692 100 (4x25)



Lock-out, snap-on type,

prevents reclosing of slide link

● 2006-7300 100 (4x25)



Accessories, 2016 Series Appropriate marking systems: WMB/Marking Strips/WMB Inline

Push-in type jumper bar, insulated,

I_N 76 A, light gray

2-way 2016-402 50 (2x25)

3-way 2016-403 50 (2x25)

4-way 2016-404 50 (2x25)

5-way 2016-405 50 (2x25)



Straight busbar, Cu with tin plating,

10 x 3 mm,

1000 mm long

I_N 140 A 210-133 1

Cover for N-busbar,

transparent,

1000 mm long

777-303 1



Banana plugs, only for safety extra-low voltage (42 V)

● 215-212 50

● 215-311 50

For additional colors, see page 262.



WMB Multi marking system, plain,

10 strips with 10 markers per card,

stretchable from 5 ... 5.2 mm

● 793-5501 5



Push-in type jumper bar, insulated,

I_N 76 A, light gray

1 to 3 2016-433 50 (2x25)

1 to 4 2016-434 50 (2x25)

1 to 5 2016-435 50 (2x25)



Testing tap,

for max. 2.5 mm²

● 2009-182 100 (4x25)



Test plug, with 500 mm cable

● 2 mm Ø 210-136 50

● 2.3 mm Ø 210-137 50



Marking strip, plain,

11 mm wide,

50 m roll

● 2009-110 1



Protective warning marker,

with high-voltage symbol, black,

for 5 terminal blocks

● 2016-115 50 (2x25)



Test plug adapter,

for 4 mm Ø test plug

● 2009-174 100 (4x25)



Finger guard,

touchproof cover protects unused

conductor entries

● 2016-100 100 (4x25)



Operating tool,

3.5 mm and 5.5 mm blades

● 2009-310 1

TOPJOB® S Function Terminal Blocks

– Description and Installation –

Fuse terminal blocks

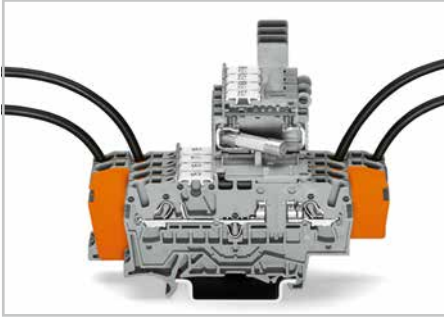

Fuse plug with blown fuse indication on a 2-conductor carrier terminal block

Disconnect/test terminal blocks



2-conductor disconnect/test terminal block with movable knife disconnect and mechanical interlock – open position

Diode and LED terminal blocks

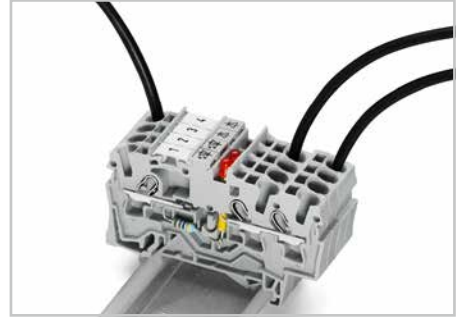

Designing custom circuits:
- via diode terminal blocks (e.g., collective fault signals)
- via LED terminal blocks (e.g., monitoring units)

Fuse replacement 1

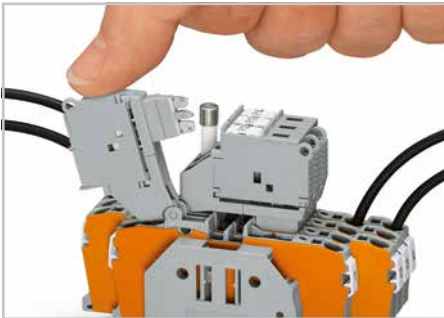

Before replacing the fuse, pivot the fuse holder into the locked open position.

Commoning and marking

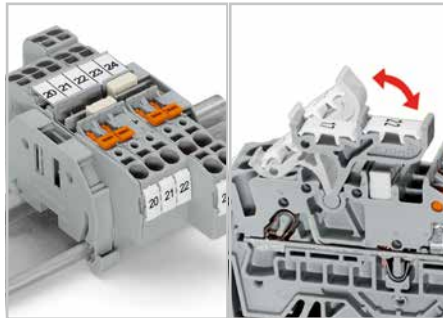

Dual jumper slots, in the same position as the 2002 Series terminal blocks. Commoning options in front of or behind the knife disconnect, depending on the power supply direction; additional marking option via pivoting marker carriers.

Commoning



Custom circuit design via push-in type jumper bars. Example shows "lamp test circuit."

Fuse replacement 2

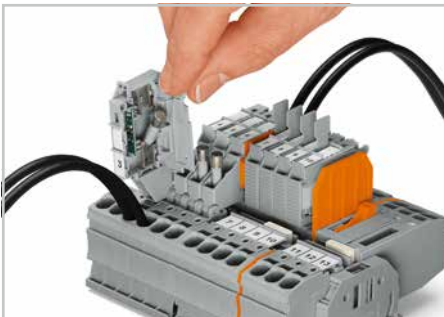

One end of the fuse is automatically ejected from the holder when opening the cover.

Disconnect/test terminal blocks



Base terminal block with disconnect plug in parked position

Application

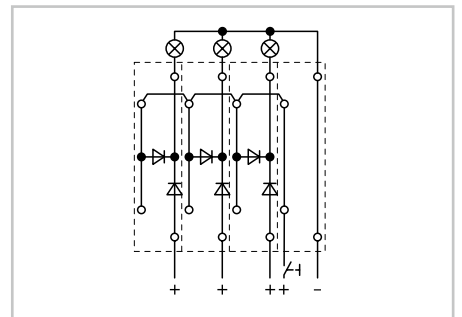

Lamp test circuit

Mini-automotive blade-style fuses

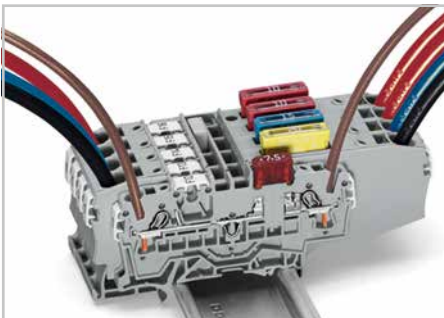

Fuse terminal block for mini-automotive blade-style fuses

Double-deck disconnect terminal blocks

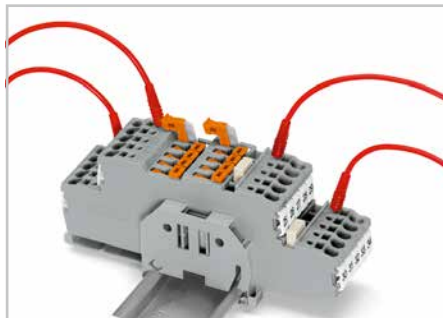

Two disconnect terminal blocks with different potential are accommodated on two levels in a double-deck disconnect terminal block.

Triple-deck diode terminal blocks

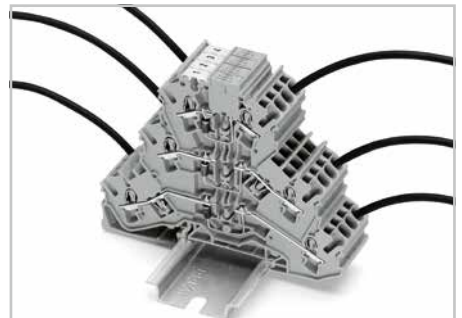

Space-saving arrangement

For information on Push-in CAGE CLAMP® connection, see page 14.

TOPJOB® S

2-Conductor Disconnect/Test and Fuse Terminal Blocks, 2002 Series

PUSH-IN CAGE CLAMP®

<p>0.25 ... 2.5 (4) mm² ① 22 ... 12 AWG 400 V/6 kV/3 I_N 16 A</p> <p>Terminal block width: 5.2 mm / 0.205 in. 10 ... 12 mm / 0.43 in.</p> <p>③ Approvals</p>	<p>0.25 ... 2.5 (4) mm² ① 22 ... 12 AWG 400 V, 15 A ② 300 V, 10 A ③</p> <p>Terminal block width: 5.2 mm / 0.205 in. 10 ... 12 mm / 0.43 in.</p> <p>③ Approvals</p>	<p>0.25 ... 2.5 (4) mm² ① 22 ... 12 AWG 250 V/6 kV/3 I_N 6.3 A ②</p> <p>Terminal block width: 6.2 mm / 0.244 in. 10 ... 12 mm / 0.43 in.</p> <p>③ Approvals</p>
---	---	--

① Conductor range: 0.25 ... 4 mm² "s+fst"
Push-in termination: 0.75 ... 4 mm² "s" and
0.75 ... 2.5 mm² "insulated ferrule, 12 mm"

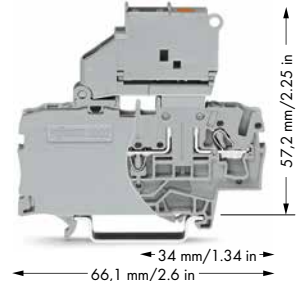
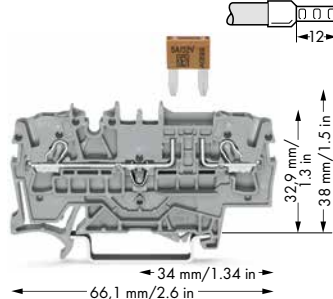
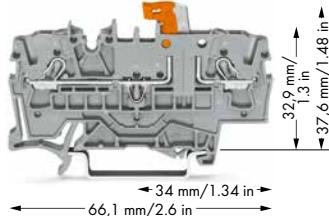

Color	Item No.	Pack. Unit	Color	Item No.	Pack. Unit	Color	Item No.	Pack. Unit
2-conductor disconnect/test terminal block			2-conductor fuse terminal block, for blade-style fuses per DIN 72581-3f, ISO 8820-3			2-conductor fuse terminal block with end plate, with blown fuse indication, for miniature metric fuses, gray		
gray	2002-1671	50	gray	2002-1681	50	12 ... 30 V ≈	2002-1611/1000-541	50
blue	2002-1674	50				30 ... 65 V ≈	2002-1611/1000-542	50
orange	2002-1672	50				120 V ≈	2002-1611/1000-867	50
2-conductor disconnect/test terminal block with mechanical interlock			- Individual arrangement: 10 A - Block arrangement: 5 A Protection against direct contact must be observed for 42 V and higher voltages.			230 V ≈ 2002-1611/1000-836 50		
gray	2002-1671/401-000	50	2-conductor fuse terminal block for mini-automotive blade-style fuses, with test point and additional jumper slot, without blown fuse indication			2-conductor fuse terminal block with end plate, without blown fuse indication, gray		
blue	2002-1674/401-000	50	gray	2002-1981	50		2002-1611	50
orange	2002-1672/401-000	50						
2-conductor through terminal block, same profile								
gray	2002-1601	50						
blue	2002-1604	50						
orange	2002-1602	50						

Item-Specific Accessories

<p>End and intermediate plate, 1 mm thick</p> <p>Orange: 2002-1692 100 (4x25)</p> <p>Gray: 2002-1691 100 (4x25)</p>	<p>End and intermediate plate, 1 mm thick</p> <p>Orange: 2002-1692 100 (4x25)</p> <p>Gray: 2002-1691 100 (4x25)</p>	<p>End plate for fuse terminal blocks, 2 mm thick</p> <p>Orange: 2002-992 100 (4x25)</p> <p>Gray: 2002-991 100 (4x25)</p>
--	--	--

Accessories, 2002 Series

Appropriate marking systems: WMB/Marking Strips/WMB Inline/Miniature WSB

<p>Adjacent jumper for continuous commoning, insulated, I_N 25 A, light gray</p> <p>2-way 2002-400 100 (4x25)</p> <p>1 to 3 2002-423 100 (4x25)</p>	<p>Push-in type jumper bar, insulated, I_N 25 A, light gray</p> <p>1 to 3 2002-433 200 (8x25)</p> <p>1 to 4 2002-434 200 (8x25)</p> <p>1 to 5 2002-435 100 (4x25)</p> <p>: : 1 to 10 2002-440 100 (4x25)</p>
<p>Push-in type jumper bar, insulated, I_N 25 A, light gray</p> <p>2-way 2002-402 200 (8x25)</p> <p>: : 10-way 2002-410 100 (4x25)</p> <p>Red: .../000-005 Blue: .../000-006</p>	<p>Modular TOPJOB® S connector, can be snapped together, I_N 24 A, for jumper contact slot</p> <p>Gray: 2002-511 100 (4x25)</p>
<p>Staggered jumper, insulated, I_N 25 A, light gray</p> <p>2-way 2002-472 100 (4x25)</p> <p>3-way 2002-473 100 (4x25)</p> <p>: : 12-way 2002-482 50 (2x25)</p>	<p>Spacer module, can be snapped together</p> <p>Gray: 2002-549 100 (4x25)</p>
<p>Insulation stop, 5 pcs/strip</p> <p>White: 2002-171 0.25-0.5 mm² 200 (8x25)</p> <p>Black: 2002-172 0.75-1 mm² 200 (8x25)</p>	<p>Protective warning marker, with high-voltage symbol, for 5 terminal blocks</p> <p>Yellow: 2002-115 100 (4x25)</p>
<p>Test plug adapter, for 4 mm Ø test plug</p> <p>2009-174 100 (4x25)</p> <p>Testing tap, for max. 2.5 mm²</p> <p>2009-182 100 (4x25)</p>	<p>Operating tool with a partially insulated shaft, type 2, (3.5 x 0.5) mm blade</p> <p>210-720 1</p>
<p>Test plug, with 500 mm cable</p> <p>Red: 2 mm Ø 210-136 50</p> <p>Yellow: 2.3 mm Ø 210-137 50</p>	

Fuse terminal blocks with a width of 6.2 mm can be assembled adjacently. If there is **no** adjacent fuse or disconnect terminal block at the end of the assembly, an end plate must be used.

When selecting miniature metric fuses, make sure that the maximum power loss listed below is not exceeded. The power loss is determined according to IEC or EN 60947-7-3/VDE 0611-6 at 23 °C. The temperature rise of the terminal blocks must be checked according to their application and mounting. Higher ambient temperatures place additional strain on fuse cartridges. Therefore, in such applications, the rated current must be reduced if necessary. More details are available from the manufacturers.

Miniature metric fuses (5 x 20 mm)

Series Item No.	Overload and short circuit protection		Short circuit protection only	
	Individual arrangement	Group arrangement	Individual arrangement	Group arrangement
Fuse terminal blocks				
2002-1611	1.6 W	1.6 W	2.5 W	2.5 W
2002-1811	1.6 W	1.6 W	2.5 W	2.5 W
2002-1811/.....	1.6 W	1.6 W	2.5 W	2.5 W
2002-1611/.....	1.6 W	1.6 W	2.5 W	2.5 W

② Nominal voltage and current are given by the fuse or blown fuse indicator.
③ For all approvals and corresponding ratings, visit www.wago.com.

For technical information and abbreviations, see technical section.

TOPJOB® S

3-Conductor Disconnect/Test and Fuse Terminal Blocks, 2002 Series

<p>0.25 ... 2.5 (4) mm² ① 22 ... 12 AWG 400 V/6 kV/3 I_N 16 A</p> <p>Terminal block width: 5.2 mm / 0.205 in. 10 ... 12 mm / 0.43 in.</p> <p>③ Approvals</p>	<p>22 ... 12 AWG 300 V, 15 A ② 300 V, 10 A ③</p>	<p>0.25 ... 2.5 (4) mm² ① 22 ... 12 AWG 400 V/6 kV/3 I_N 10 A ②</p> <p>Terminal block width: 5.2 mm / 0.205 in. 10 ... 12 mm / 0.43 in.</p> <p>③ Approvals</p>	<p>22 ... 12 AWG 300 V, 10 A ② 300 V, 10 A ③</p>	<p>0.25 ... 2.5 (4) mm² ① 22 ... 12 AWG 250 V/6 kV/3 I_N 6.3 A ②</p> <p>Terminal block width: 6.2 mm / 0.244 in. 10 ... 12 mm / 0.43 in.</p> <p>③ Approvals</p>	<p>22 ... 12 AWG</p>
---	--	---	--	--	----------------------

① Conductor range: 0.25 ... 4 mm² "s+f-st"
Push-in termination: 0.75 ... 4 mm² "s" and
0.75 ... 2.5 mm² "insulated ferrule, 12 mm"

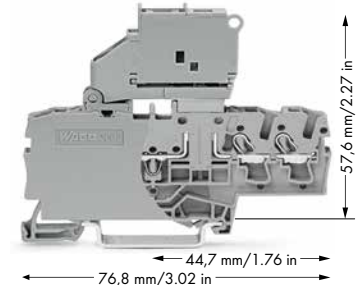
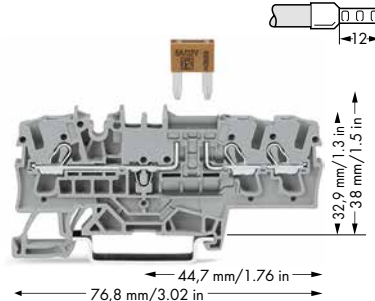
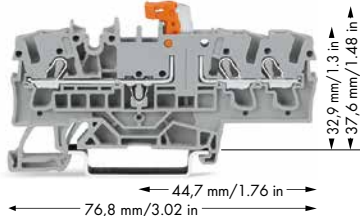

Color	Item No.	Pack. Unit	Color	Item No.	Pack. Unit	Color	Item No.	Pack. Unit
3-conductor disconnect/test terminal block			3-conductor fuse terminal block, for blade-style fuses per DIN 72581-3f, ISO 8820-3			3-conductor fuse terminal block with end plate, with blown fuse indication by LED, gray		
gray	2002-1771	50	gray	2002-1781	50	12 ... 30 V ≈	2002-1711/1000-541	50
blue	2002-1774	50				30 ... 65 V ≈	2002-1711/1000-542	50
orange	2002-1772	50				120 V ≈	2002-1711/1000-867	50
3-conductor disconnect/test terminal block with mechanical interlock			- Individual arrangement: 10 A - Block arrangement: 5 A Protection against direct contact must be observed for 42 V and higher voltages.			230 V ≈ 2002-1711/1000-836 50		
gray	2002-1771/401-000	50				3-conductor fuse terminal block with end plate, without blown fuse indication		
blue	2002-1774/401-000	50				gray 2002-1711 50		
orange	2002-1772/401-000	50						
3-conductor through terminal block, same profile								
gray	2002-1701	50						
blue	2002-1704	50						
orange	2002-1702	50						

Item-Specific Accessories

<p>End and intermediate plate, 1 mm thick</p> <p>orange 2002-1792 100 (4x25) gray 2002-1791 100 (4x25)</p>	<p>End and intermediate plate, 1 mm thick</p> <p>orange 2002-1792 100 (4x25) gray 2002-1791 100 (4x25)</p>	<p>End plate for fuse terminal blocks, 2 mm thick</p> <p>orange 2002-992 100 (4x25) gray 2002-991 100 (4x25)</p>
---	---	---

Accessories, 2002 Series

Appropriate marking systems: **WMB/Marking Strips/WMB Inline/Miniature WSB**

<p>Adjacent jumper for continuous commoning, insulated, I_N 25 A, light gray 2-way 2002-400 100 (4x25) 1 to 3 2002-423 100 (4x25)</p>	<p>Push-in type jumper bar, insulated, I_N 25 A, light gray 1 to 3 2002-433 200 (8x25) 1 to 4 2002-434 200 (8x25) 1 to 5 2002-435 100 (4x25) : : 1 to 10 2002-440 100 (4x25)</p>	<p>Push-in type jumper bar, insulated, I_N 25 A, light gray 2-way 2004-402 200 (8x25) : : 10-way 2004-410 100 (4x25)</p>
<p>Push-in type jumper bar, insulated, I_N 25 A, light gray 2-way 2002-402 200 (8x25) : : 10-way 2002-410 100 (4x25) .../000-005 .../000-006</p>	<p>Modular TOPJOB® S L-test plug, can be snapped together, I_N 18 A, for conductor entry 2002-611 100 (4x25)</p>	<p>Push-in type jumper bar, insulated, I_N 25 A, light gray 1 ... 3 2004-433 200 (8x25) : : 1 ... 10 2004-440 100 (4x25)</p>
<p>Staggered jumper, light gray, insulated, I_N 25 A 2-way 2002-472 100 (4x25) 3-way 2002-473 100 (4x25) : : 12-way 2002-482 50 (2x25)</p>	<p>Spacer module, can be snapped together 2002-649 100 (4x25)</p>	<p>Note: Due to the 6.2 mm width of fuse disconnect terminal blocks with pivoting fuse holder, 2004 Series Push-In Type Jumper Bars must be used.</p>
<p>Insulation stop, 5 pcs/strip 2002-171 0.25-0.5 mm² 2002-172 0.75-1 mm² 200 (8x25)</p>	<p>Protective warning marker, with high-voltage symbol, for 5 terminal blocks 2002-115 100 (4x25)</p>	<p>Test plug, with 500 mm cable 2 mm Ø 210-136 50 2.3 mm Ø 210-137 50</p>
<p>Test plug adapter, for 4 mm Ø test plug 2009-174 100 (4x25) Testing tap, for max. 2.5 mm² 2009-182 100 (4x25)</p>	<p>WMB Multi marking system, plain, 10 strips with 10 markers per card, stretchable from 5 ... 5.2 mm 793-5501 5</p>	<p>Insulated ferrules, extra long, for TOPJOB® S terminal blocks, see page 259</p>
<p>Double-deck marker carrier, pivoting 2002-121 50 (2x25)</p>		<p>Operating tool with a partially insulated shaft, type 2, (3.5 x 0.5) mm blade 210-720 1</p>

② Nominal voltage and current are given by the fuse or blown fuse indicator.
③ For all approvals and corresponding ratings, visit www.wago.com.

For technical information and abbreviations, see technical section.

TOPJOB® S

4-Conductor Disconnect/Test and Fuse Terminal Blocks, 2002 Series

PUSH-IN CAGE CLAMP®

0.25 ... 2.5 (4) mm² ①
400 V/6 kV/3
I_N 16 A

22 ... 12 AWG
300 V, 15 A ②
300 V, 15 A ③

Terminal block width: 5.2 mm / 0.205 in.
10 ... 12 mm / 0.43 in.

③ Approvals

① Conductor range: 0.25 ... 4 mm² "s+fst"
Push-in termination: 0.75 ... 4 mm² "s" and
0.75 ... 2.5 mm² "insulated ferrule, 12 mm"

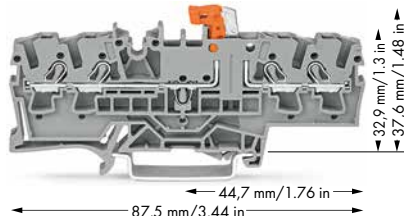

0.25 ... 2.5 (4) mm² ①
400 V/6 kV/3
I_N 10 A ②

22 ... 12 AWG
300 V, 10 A ②
300 V, 10 A ③

Terminal block width: 5.2 mm / 0.205 in.
10 ... 12 mm / 0.43 in.

③ Approvals

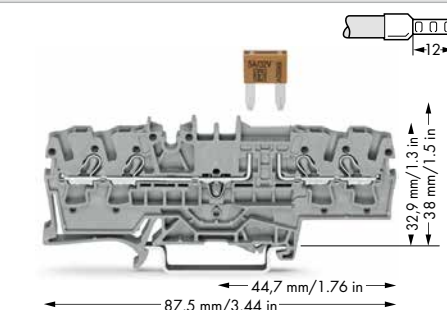

0.25 ... 2.5 (4) mm² ①
250 V/6 kV/3
I_N 6.3 A ②

22 ... 12 AWG
250 V, 6 A ②
250 V, 6 A ③

Terminal block width: 6.2 mm / 0.244 in.
10 ... 12 mm / 0.43 in.

③ Approvals

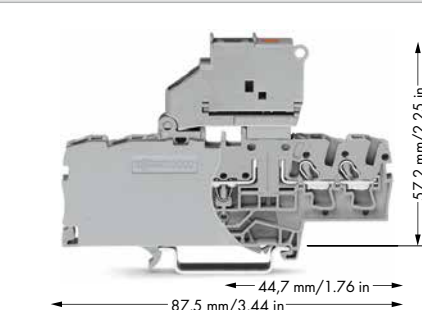

Color	Item No.	Pack. Unit	Color	Item No.	Pack. Unit	Color	Item No.	Pack. Unit
4-conductor disconnect/test terminal block			4-conductor fuse terminal block, for blade-style fuses per DIN 72581-3f, ISO 8820-3			4-conductor fuse terminal block with end plate, with blown fuse indication by LED, gray		
gray	2002-1871	50	gray	2002-1881	50	12 ... 30 V ≈	2002-1811/1000-541	50
blue	2002-1874	50				30 ... 65 V ≈	2002-1811/1000-542	50
orange	2002-1872	50				120 V ≈	2002-1811/1000-867	50
4-conductor disconnect/test terminal block with mechanical interlock			- Individual arrangement: 10 A - Block arrangement: 5 A Protection against direct contact must be observed for 42 V and higher voltages.			230 V ≈ 2002-1811/1000-836 50		
gray	2002-1871/401-000	50				4-conductor fuse terminal block with end plate, without blown fuse indication		
blue	2002-1874/401-000	50				gray	2002-1811	50
orange	2002-1872/401-000	50						
4-conductor through terminal block, same profile								
gray	2002-1801	50						
blue	2002-1804	50						
orange	2002-1802	50						

Item-Specific Accessories

End and intermediate plate, 1 mm thick

orange	2002-1892	100 (4x25)
gray	2002-1891	100 (4x25)

End and intermediate plate, 1 mm thick

orange	2002-1892	100 (4x25)
gray	2002-1891	100 (4x25)

End plate for fuse terminal blocks, 2 mm thick

orange	2002-992	100 (4x25)
gray	2002-991	100 (4x25)

Accessories, 2002 Series

Appropriate marking systems: WMB/Marking Strips/WMB Inline/Miniature WSB

Adjacent jumper for continuous commoning, insulated,

I _N 25 A, light gray		
2-way	2002-400	100 (4x25)
1 to 3	2002-423	100 (4x25)

Push-in type jumper bar, insulated,

I _N 25 A, light gray		
2-way	2002-402	200 (8x25)
:	:	:
10-way	2002-410	100 (4x25)
.../000-005	.../000-006	

Staggered jumper, insulated,

I _N 25 A, light gray		
2-way	2002-472	100 (4x25)
3-way	2002-473	100 (4x25)
:	:	:
12-way	2002-482	50 (2x25)

Insulation stop, 5 pcs/strip

○	2002-171	0.25-0.5 mm ²	
●	2002-172	0.75-1 mm ²	200 (8x25)

Test plug adapter, for 4 mm Ø test plug

	2009-174	100 (4x25)
Testing tap, for max. 2.5 mm ²	2009-182	100 (4x25)

Double-deck marker carrier, pivoting

○	2002-121	50 (2x25)
---	----------	-----------

Push-in type jumper bar, insulated,

I _N 25 A, light gray		
1 to 3	2002-433	200 (8x25)
1 to 4	2002-434	200 (8x25)
1 to 5	2002-435	100 (4x25)
:	:	:
1 to 10	2002-440	100 (4x25)

Modular TOPJOB® S connector, can be snapped
together, I_N 24 A, for jumper
contact slot

○	2002-511	100 (4x25)
---	----------	------------

Spacer module, can be snapped together

○	2002-549	100 (4x25)
---	----------	------------

Protective warning marker, with high-voltage symbol,

○	2002-115	100 (4x25)
---	----------	------------

WMB Multi marking system, plain,

○	793-5501	5
---	----------	---

Push-in type jumper bar, insulated,

I _N 25 A, light gray		
2-way	2004-402	200 (8x25)
:	:	:
10-way	2004-410	100 (4x25)

Push-in type jumper bar, insulated,

I _N 25 A, light gray		
1 ... 3	2004-433	200 (8x25)
:	:	:
1 ... 10	2004-440	100 (4x25)

Note: Due to the 6.2 mm width of fuse disconnect terminal blocks with pivoting fuse holder, 2004 Series Push-In Type Jumper Bars must be used.

Test plug, with 500 mm cable

○	2 mm Ø	210-136	50
●	2.3 mm Ø	210-137	50

Insulated ferrules, extra long,

for TOPJOB® S terminal blocks,
see page 259

Operating tool with a partially insulated shaft,

	type 2, (3.5 x 0.5) mm blade	210-720	1
--	------------------------------	---------	---

② Nominal voltage and current are given by the fuse or blown fuse indicator.









③ For all approvals and corresponding ratings, visit www.wago.com.

For technical information and abbreviations, see technical section.

TOPJOB® S

2-, 3- and 4-Conductor Carrier Terminal Blocks, 2002 Series

Fuse Plugs, 2004 Series, Double-fuse Plugs, 2003 Series

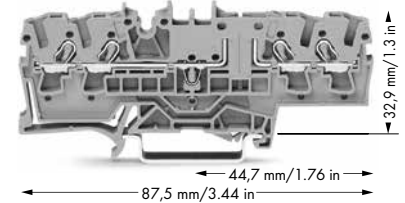
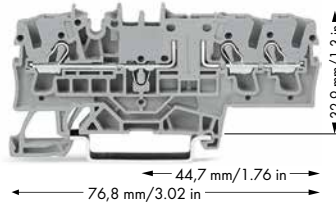
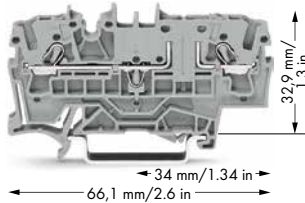

<p>0.25 ... 2.5 (4) mm² ①</p> <p>22 ... 12 AWG</p> <p>400 V/6 kV/3</p> <p>I_N 6.3 A</p> <p>Terminal block width: 5.2 mm / 0.205 in.</p> <p> 10 ... 12 mm / 0.43 in.</p> <p>③ Approvals</p>	<p>22 ... 12 AWG</p> <p>300 V, 15 A </p> <p>300 V, 10 A </p>	<p>0.25 ... 2.5 (4) mm² ①</p> <p>22 ... 12 AWG</p> <p>400 V/6 kV/3</p> <p>I_N 6.3 A</p> <p>Terminal block width: 5.2 mm / 0.205 in.</p> <p> 10 ... 12 mm / 0.43 in.</p> <p>③ Approvals</p>	<p>22 ... 12 AWG</p> <p>300 V, 15 A </p> <p>300 V, 10 A </p>	<p>0.25 ... 2.5 (4) mm² ①</p> <p>22 ... 12 AWG</p> <p>400 V/6 kV/3</p> <p>I_N 6.3 A</p> <p>Terminal block width: 5.2 mm / 0.205 in.</p> <p> 10 ... 12 mm / 0.43 in.</p> <p>③ Approvals</p>	<p>22 ... 12 AWG</p> <p>300 V, 15 A </p> <p>300 V, 10 A </p>
--	--	--	--	--	--

① Conductor range: 0.25 ... 4 mm² "s+fst"
 Push-in termination: 0.75 ... 4 mm² "s" and
 0.75 ... 2.5 mm² "insulated ferrule, 12 mm"



Color	Item No.	Pack. Unit	Color	Item No.	Pack. Unit	Color	Item No.	Pack. Unit
2-conductor carrier terminal block			3-conductor carrier terminal block			4-conductor carrier terminal block		
● gray	2002-1661	50	● gray	2002-1761	50	● gray	2002-1861	50

Item-Specific Accessories

<p>End and intermediate plate, 1 mm thick</p> <p> ● 2002-1692 100 (4x25)</p> <p>● 2002-1691 100 (4x25)</p>	<p>End and intermediate plate, 1 mm thick</p> <p> ● 2002-1792 100 (4x25)</p> <p>● 2002-1791 100 (4x25)</p>	<p>End and intermediate plate, 1 mm thick</p> <p> ● 2002-1892 100 (4x25)</p> <p>● 2002-1891 100 (4x25)</p>
--	--	--

Accessories, 2002 Series

Appropriate marking systems: **WMB/Marking Strips/WMB Inline**

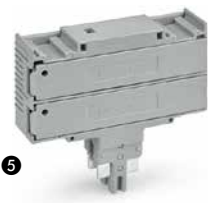
<p>Adjacent jumper for continuous commoning, insulated,</p> <p>I_N 25 A, light gray</p> <p>2-way 2002-400 100 (4x25)</p> <p>1 to 3 2002-423 100 (4x25)</p>	<p>Push-in type jumper bar, insulated,</p> <p>I_N 25 A, light gray</p> <p>1 to 3 2002-433 200 (8x25)</p> <p>1 to 4 2002-434 200 (8x25)</p> <p>1 to 5 2002-435 100 (4x25)</p> <p>: : 1 to 10 2002-440 100 (4x25)</p>	 ④  ⑤
<p>Push-in type jumper bar, insulated,</p> <p>I_N 25 A, light gray</p> <p>2-way 2002-402 200 (8x25)</p> <p>3-way 2002-403 200 (8x25)</p> <p>4-way 2002-404 200 (8x25)</p> <p>: : 10-way 2002-410 100 (4x25)</p> <p>● .../000-005 ● .../000-006</p>	<p>Modular TOPJOB® S L-test plug, can be snapped together, I_N 18 A, for conductor entry</p> <p>● 2002-611 100 (4x25)</p>	
<p>Staggered jumper, insulated,</p> <p>I_N 25 A, light gray</p> <p>2-way 2002-472 100 (4x25)</p> <p>3-way 2002-473 100 (4x25)</p> <p>4-way 2002-474 100 (4x25)</p> <p>5-way 2002-475 50 (2x25)</p> <p>: : 12-way 2002-482 50 (2x25)</p>	<p>Spacer module, can be snapped together</p> <p>● 2002-649 100 (4x25)</p>	<p>④ Fuse plug, with pull-tab,</p> <p>for 5 x 20 mm miniature metric fuses</p> <p>2004-911 50</p>
<p>Insulation stop, 5 pcs/strip</p> <p>○ 2002-171 0.25-0.5 mm²</p> <p>● 2002-172 0.75-1 mm²</p> <p>200 (8x25)</p>	<p>Disconnect plug for fuse terminal blocks,</p> <p>suitable when using a fuse terminal block as disconnect terminal block</p> <p>2002-401 100 (4x25)</p>	<p>with LED, can be used in both switching directions</p> <p>LED, AC/DC 12 ... 30 V</p> <p>2004-911/1000-541 50</p> <p>LED, AC/DC 30 ... 65 V</p> <p>2004-911/1000-542 50</p> <p>LED, AC/DC 120 ... 250 V</p> <p>2004-911/1000-836 50</p>
<p>Test plug adapter, for 4 mm Ø test plug</p> <p>2009-174 100 (4x25)</p> <p>Testing tap, for max. 2.5 mm²</p> <p>2009-182 100 (4x25)</p>	<p>Protective warning marker, with high-voltage symbol, for 5 terminal blocks</p> <p>● 2002-115 100 (4x25)</p>	<p>Double-fuse plug, for 2x 5 x 20 mm</p> <p>type 1 ⑤, 2-pole, 10.4 mm</p> <p>2003-911 100</p> <p>type 2 ⑤, 2-pole, 10.4 mm, LED 250 V</p> <p>2003-911/1000-923 100</p>
<p>Marking strips, plain</p> <p>11 mm wide, 50 m roll</p> <p>○ 2009-110 1</p>	<p>Banana plugs, only for safety extra-low voltage (42 V)</p> <p>● 215-212 50</p> <p>● 215-311 50</p> <p>For additional colors, see page 262.</p>	<p>Shorting link, 5 x 20 mm, 6.3 A,</p> <p>suitable when using the fuse plug as a disconnect plug</p> <p>281-503 250 (10x25)</p>
<p>End plate for fuse terminal blocks, 2 mm thick</p> <p>● 2002-992 100 (4x25)</p> <p>● 2002-991 100 (4x25)</p>	<p>WMB Multi marking system, plain,</p> <p>10 strips with 10 markers per card, stretchable from 5 ... 5.2 mm</p> <p>○ 793-5501 5</p>	<p>For pluggable diode and LED modules, see page 28.</p> <p>For empty component plug housings, see page 236.</p>
<p>Operating tool with a partially insulated shaft,</p> <p>type 2, (3.5 x 0.5) mm blade</p> <p>○ 210-720 1</p>		

TOPJOB® S

Disconnect and Fuse Terminal Blocks 6 (10) mm²

2006 Series

PUSH-IN CAGE CLAMP®

1

<p>0.5 ... 6 (10) mm² ① 20 ... 8 AWG 800 V/6 kV/3 I_N 30 A Terminal block width: 7.5 mm / 0.295 in. 13 ... 15 mm / 0.55 in. ③ Approvals</p>	<p>0.2 ... 6 (10) mm² ① 20 ... 8 AWG 800 V/8 kV/3 ② I_N 25/30 A ② Terminal block width: 7.5 mm / 0.295 in. 13 ... 15 mm / 0.55 in. ③ Approvals</p>	<p>0.5 ... 6 (10) mm² ① 20 ... 8 AWG 500 V/6 kV/3 I_N 30 A Terminal block width: 15 mm / 0.59 in. 13 ... 15 mm / 0.55 in. ③ Approvals</p>
--	---	--

① see page 29

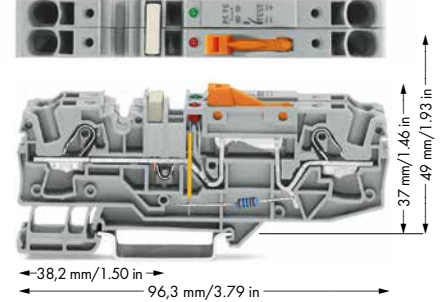
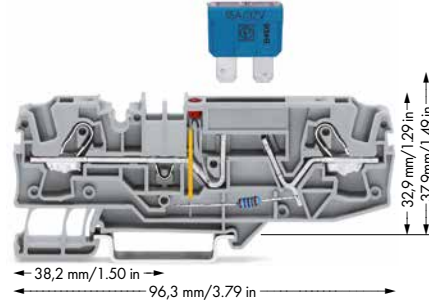
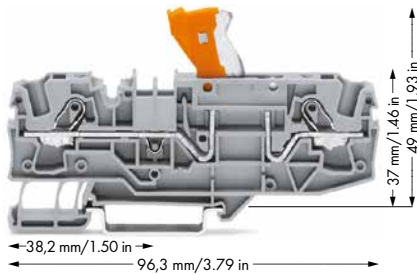

Color	Item No.	Pack. Unit	Color	Item No.	Pack. Unit	Color	Item No.	Pack. Unit
2-conductor disconnect terminal block, with test point, orange disconnect link			2-conductor fuse terminal block for mini-automotive blade-style fuses, with blown fuse indication by LED, with test point, gray			Ground conductor disconnect terminal block, gray		
gray	2006-1671	25	12 V			24 V AC/DC	2006-1671/1000-848	12
blue	2006-1674	25	24 V			48 V AC/DC	2006-1671/1000-849	12
2-conductor through terminal block, same profile			12 V			120 V AC/DC	2006-1671/1000-850	12
gray	2006-1601	25	24 V			230 V AC/DC	2006-1671/1000-851	12
blue	2006-1604	25	48 V					
			without blown-fuse indication, with test option					
			gray	2006-1681	25			

Item-Specific Accessories

End and intermediate plate, 1 mm thick

orange	2006-1692	100 (4x25)
gray	2006-1691	100 (4x25)

End and intermediate plate, 1 mm thick

orange	2006-1692	100 (4x25)
gray	2006-1691	100 (4x25)

Accessories, 2006 Series

Push-in type jumper bar, insulated, I_N 41 A, light gray

2-way	2006-402	50 (2x25)
3-way	2006-403	50 (2x25)
4-way	2006-404	50 (2x25)
5-way	2006-405	50 (2x25)

Appropriate marking systems:

WMB/Marking Strips/WMB Inline

Push-in type jumper bar, insulated, I_N 41 A, light gray

1 to 3	2006-433	50 (2x25)
1 to 4	2006-434	50 (2x25)
1 to 5	2006-435	50 (2x25)

Disconnect plug for fuse terminal blocks, suitable when using a fuse terminal block as disconnect terminal block

orange	2006-401	100 (4x25)
--------	----------	------------

Protective warning marker, with high-voltage symbol, for 5 terminal blocks

yellow	2006-115	100 (4x25)
--------	----------	------------

Disconnect plug for carrier terminal blocks, suitable when using a carrier terminal block as disconnect terminal block

white	2006-401/000-005	100 (4x25)
-------	------------------	------------

Test plug adapter, for 4 mm Ø test plug

gray	2009-174	100 (4x25)
------	----------	------------

Blind plug for fuse terminal blocks, indicates a disconnection

red	2006-451	100 (4x25)
-----	----------	------------

Banana plugs, only for safety extra-low voltage (42 V)

red	215-212	50
black	215-311	50

For additional colors, see page 262.

Blade-style fuses, per DIN 72581-3c/ISO 8820 (not offered by WAGO)

Overcurrent circuit breaker*, thermal (not offered by WAGO)

*WAGO recommends using overcurrent circuit breakers from ETA, Elektrotechnische Apparate GmbH, Postfach 1061, D-90514 Aldorf/Nürnberg; Types 1170-02, 1621-21 or 1610-22; Individual or block arrangement up to 25 A for 4 mm² conductors.

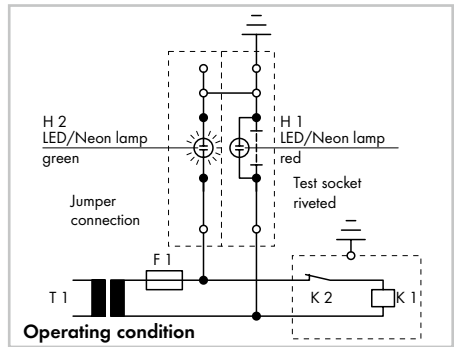
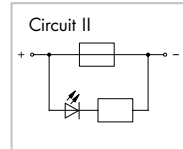
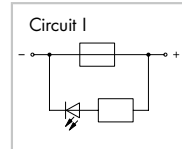

Slide link closed, auxiliary circuit grounded, green LED/neon lamp illuminates.

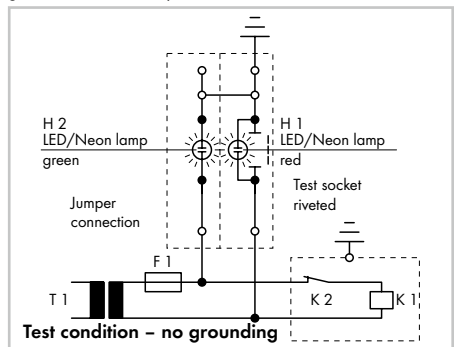

Slide link open, auxiliary circuit not grounded.

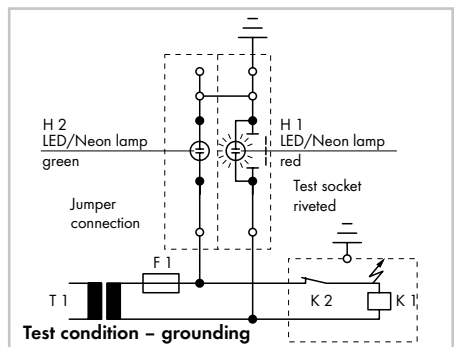

Slide link open, auxiliary circuit not grounded, red LED/neon lamp illuminates.

② Nominal voltage and current are given by the fuse or blown fuse indicator.
③ For all approvals and corresponding ratings, visit www.wago.com.

TOPJOB® S

Fuse Disconnect Terminal Blocks with Pivoting Fuse Holder, for 5 x 20 mm, 5 x 30 mm and 1/4" x 1 1/4" Miniature Metric Fuses, 2006 Series

0.5 ... 6 (10) mm ² ① 800 V/8 kV/3 ② I _N 10 A Terminal block width: 7.5 mm / 0.295 in. 13 ... 15 mm / 0.55 in. ③ Approvals	20 ... 8 AWG 600 V, 15 A ③ Terminal block width: 7.5 mm / 0.295 in. 13 ... 15 mm / 0.55 in. ③ Approvals	0.5 ... 6 (10) mm ² ① 800 V/8 kV/3 ② I _N 10 A Terminal block width: 10.4 mm / 0.409 in. 13 ... 15 mm / 0.55 in. ③ Approvals	20 ... 8 AWG 600 V, 15 A ③ Terminal block width: 10.4 mm / 0.409 in. 13 ... 15 mm / 0.55 in. ③ Approvals
---	---	--	--

- ① Conductor range: 0.5 ... 10 mm² "s+fst"
Push-in termination: 1 ... 10 mm² "s"
and 1.5 ... 6 mm² "insulated ferrules, 12 mm"
- ② 800 V = Rated voltage
8 kV = Rated impulse voltage
3 = Pollution degree

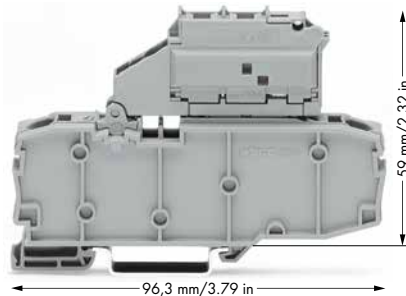
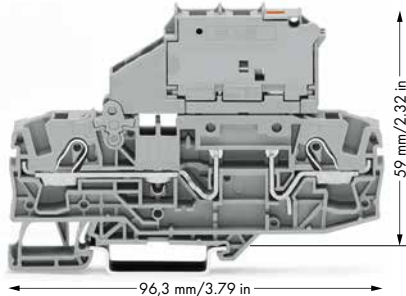

Color	Item No.	Pack. Unit	Color	Item No.	Pack. Unit	Accessories, 2006 Series (7.5 mm-wide terminal blocks)
2-conductor fuse disconnect terminal block with pivoting fuse holder, with blown fuse indication, nominal voltage/current given by the fuse, for 5 x 20 mm miniature metric fuse			2-conductor fuse disconnect terminal block with pivoting fuse holder and end plate, with blown fuse indication, nominal voltage/current given by the fuse, for 1/4" x 1 1/4" miniature metric fuse			Push-in type jumper bar, insulated, I _N 41 A, light gray
gray	2006-1611	25	gray	2006-1631/099-000	25	2-way 2006-402 50 (2x25) 3-way 2006-403 50 (2x25) 4-way 2006-404 50 (2x25) 5-way 2006-405 50 (2x25)
for 5 x 30 mm miniature metric fuse						Push-in type jumper bar, insulated, I _N 41 A, light gray
gray	2006-1621	25				1 to 3 2006-433 50 (2x25) 1 to 4 2006-434 50 (2x25) 1 to 5 2006-435 50 (2x25)
for 1/4" x 1 1/4" miniature metric fuse						Star point jumper, insulated, I _N = I _N terminal block, light gray
gray	2006-1631	25				1-3-5 2006-405/011-000 50 (2x25)
with blown fuse indication by LED, nominal voltage/current given by LED or fuse, leakage current in case of blown fuse: LED 2 mA, for 5 x 20 mm miniature metric fuse			with blown fuse indication by LED, nominal voltage/current given by LED or fuse, leakage current in case of blown fuse: LED 2 mA, for 1/4" x 1 1/4" miniature metric fuse			Protective warning marker, with high-voltage symbol, black, for 5 terminal blocks
12 ... 30 V	2006-1611/1000-541	25	12 ... 30 V	2006-1631/1099-541	25	④ 2006-115 100 (4x25)
30 ... 65 V	2006-1611/1000-542	25	30 ... 65 V	2006-1631/1099-542	25	
120 V	2006-1611/1000-867	25	120 V	2006-1631/1099-867	25	Accessories, 2006 Series (10.4 mm-wide terminal blocks)
230 V	2006-1611/1000-836	25	230 V	2006-1631/1099-836	25	*Note: Due to the 10.4 mm width of fuse disconnect terminal blocks with a pivoting fuse holder, 2002 Series Push-In Type Jumper Bars must be used.
for 5 x 30 mm miniature metric fuse						Push-in type jumper bar, insulated, I _N 25 A, light gray
12 ... 30 V	2006-1621/1000-541	25				1 to 2* 2002-433 200 (8x25) 1 to 3* 2002-435 100 (4x25) 1 to 4* 2002-437 100 (4x25) 1 to 5* 2002-439 100 (4x25)
30 ... 65 V	2006-1621/1000-542	25				Star point jumper, insulated, I _N = I _N terminal block, light gray
120 V	2006-1621/1000-867	25				1-2-3* 2002-405/011-000 100 (4x25)
230 V	2006-1621/1000-836	25				
380 ... 500 V	2006-1621/1000-859	25				
for 1/4" x 1 1/4" miniature metric fuse						
12 ... 30 V	2006-1631/1000-541	25				
30 ... 65 V	2006-1631/1000-542	25				
120 V	2006-1631/1000-867	25				
230 V	2006-1631/1000-836	25				
380 ... 500 V	2006-1631/1000-859	25				

Item-Specific Accessories	Appropriate marking systems: WMB/Marking Strips	Accessories, 2006 Series
End and intermediate plate, 1 mm thick	End plate for fuse terminal blocks, 2 mm thick	WMB Multi marking system, plain, 10 strips with 10 markers per card, stretchable from 5 ... 5.2 mm
2006-1692 100 (4x25)	2006-992 100 (4x25)	793-5501 5
2006-1691 100 (4x25)	2006-991 100 (4x25)	Screwless end stop, for DIN-35 rail, 6 mm wide
2006-992 100 (4x25)		249-116 100 (4x25)
2006-991 100 (4x25)		

③ For all approvals and corresponding ratings, visit www.wago.com.

For technical information and abbreviations, see technical section.

TOPJOB® S

PUSH-IN CAGE CLAMP®

Disconnect/Test Terminal Blocks, 1500 VDC, Carrier Terminal Blocks and Through Terminal Blocks of Same Profile 6 (10) mm² / 30 A, 2006 Series

0.5 ... 6 (10) mm² ① | 20 ... 8 AWG
 AC/DC 1000 V/ DC 1500 V/12 kV/3 ②
 I_N 30 A 600 V, 30 A_{VA}, 1000 V, 30 A_{AE}
 Terminal block width: 15 mm / 0.59 in.
 13 ... 15 mm / 0.55 in.
 ③ Approvals

0.5 ... 6 (10) mm² ① | 20 ... 8 AWG
 AC/DC 1000 V/ DC 1500 V/12 kV/3 ②
 I_N 30 A 600 V, 30 A_{VA}, 1000 V, 30 A_{AE}
 Terminal block width: 15 mm / 0.59 in.
 13 ... 15 mm / 0.55 in.
 ③ Approvals

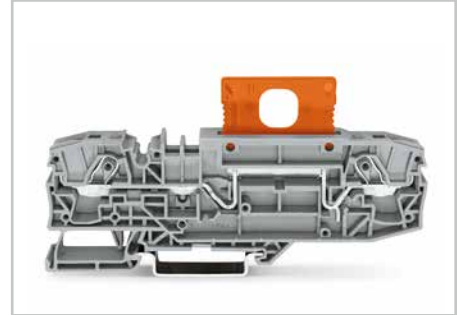

Orange disconnect plug (2006-8401) in operating position

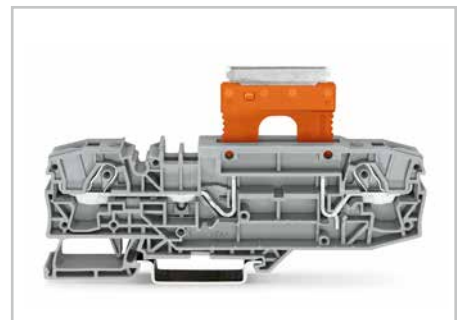

Orange disconnect plug (2006-8401) in "visible disconnection" position

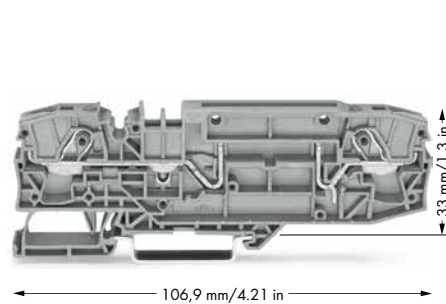
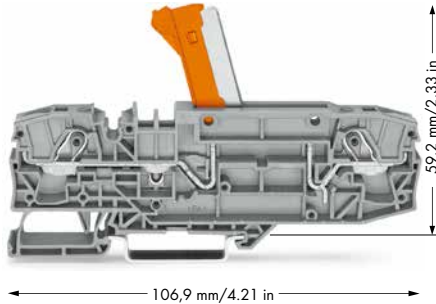

Color	Item No.	Pack. Unit	Color	Item No.	Pack. Unit
2-conductor disconnect/test terminal block, with test point, orange disconnect link			2-conductor carrier terminal block, with test point		
gray	2006-8671	12	gray	2006-8661	12
blue	2006-8674	12	blue	2006-8664	12
2-conductor through terminal block, with test point, same profile as 2-conductor disconnect terminal block			Item-Specific Accessories		
gray	2006-8601	12	Disconnect plug for carrier terminal blocks, suitable when using a carrier terminal block as disconnect terminal block		
blue	2006-8604	12		2006-8401	48 (4x12)

Accessories, 2006 Series

End and intermediate plate, 1 mm thick 2006-8692 48 (4x12) 2006-8691 48 (4x12)	WMB Multi marking system, plain, 10 strips with 10 markers per card, for 5 ... 17.5 mm terminal block width 793-501 5
Protective warning marker, ④ with high-voltage symbol, black, for 5 terminal blocks 2006-115 100 (4x25)	WMB Multi marking system, plain 10 strips with 10 markers per card, for 5 ... 17.5 mm terminal block width 793-501/000-002 5 793-501/000-005 5 793-501/000-006 5 793-501/000-007 5 793-501/000-012 5 793-501/000-017 5 793-501/000-023 5 793-501/000-024 5
Push-in type jumper bar, insulated, I _N 41 A, light gray 1 to 2 2006-433 50 (2x25) 1 to 3 2006-435 50 (2x25)	Marking strip, plain, 11 mm wide, 50 m roll 2009-110 1
Star point jumper (as push-in type jumper bar), insulated, I _N = I _N terminal block, light gray 1-2-3 2006-405/011-000 50 (2x25)	WMB Inline, plain, stretchable from 5 ... 5.2 mm, 1,500 WMB markers (5 mm) per roll 2009-115 1
Lockout cap, for conductor entry and operating slot 2006-191 25	Screwless end stop, for DIN-35 rail, 10 mm wide 249-117 50(2x25)
Test plug, with 500 mm cable, 2 mm Ø 210-136 50	

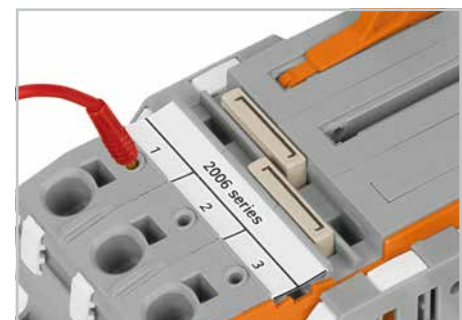

Commoning a 15 mm-wide terminal block via push-in type jumper bars: 1 to 3 (2006-433) and 1 to 5 (2006-435). Test slots on both terminal block sides allow for direct measurement.

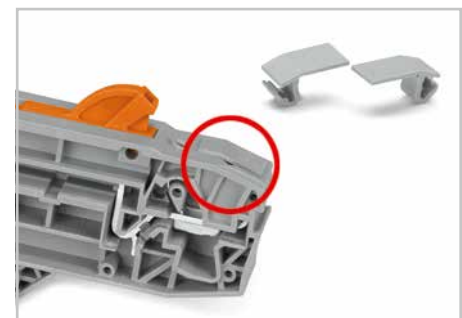

Cover seals unused conductor entry.

④ Protective warning markers must be applied individually.

TOPJOB® S Current Transformer Terminal Blocks, 2007-8821 (Orange Disconnect Link)

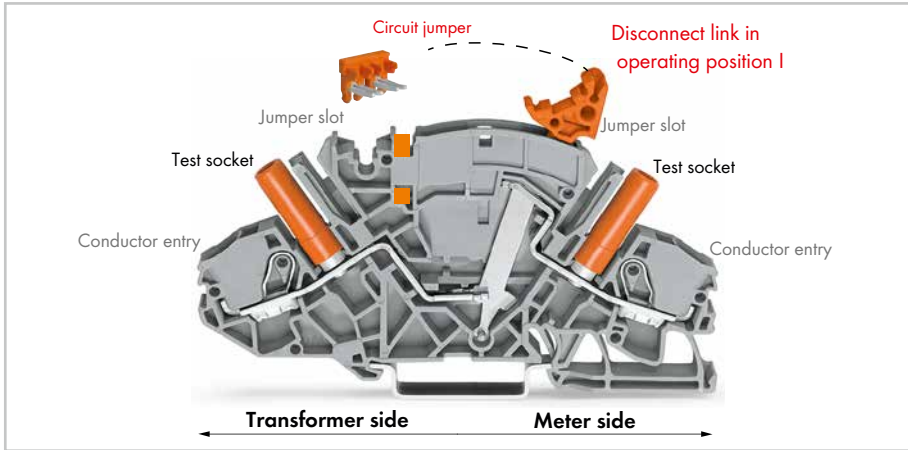

WAGO's TOPJOB® S Current Transformer (Disconnect/Test) Terminal Block (2007-8821) is designed for current transformer circuits.

First, the current transformer is shorted via disconnect link and circuit jumper (insert jumper, move disconnect link from operating position I to shorting position II, activate shorting path). Connecting a measurement device via test socket on the meter side can only be performed once circuit disconnection is complete (disconnect link in measuring position III).

- Features top-of-unit circuit jumper slot for shorting path activation.
- Disconnect link provides intuitive and easy operation, as well as exact switching status indication.
- Combines high functionality with compact design (99.6 mm long and 8 mm wide).
- All 2007 Series terminal blocks are rated at 30 A/500 V (IEC) and 300 V (UL).
- With a terminal block width of 8 mm, the maximum cross-section for solid and fine-stranded conductors is 10 mm² (8 AWG) and 6 mm² (10 AWG) for ferruled conductors.
- Touch-proof test sockets for 4 mm Ø test plugs on transformer and meter side.
- Compatible with through and ground conductor terminal blocks of same profile.

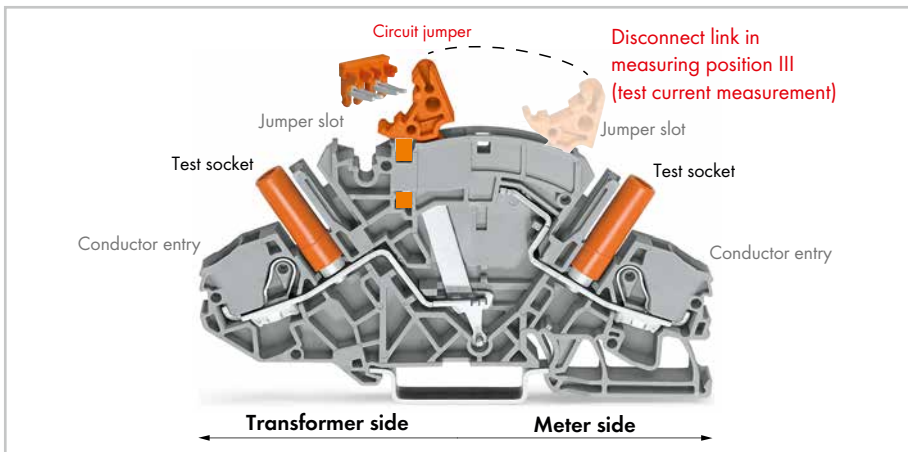
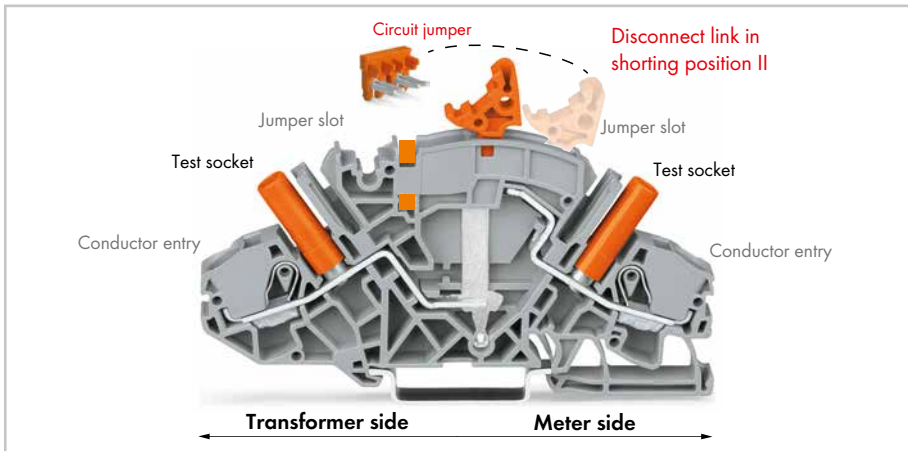

Preparing the shorting path for current transformer circuits:

Insert insulated, touch-proof circuit jumpers into jumper slot. Using locking covers or profiles for adjacent terminal blocks allows disconnect links to be operated simultaneously.

TOPJOB® S Current Transformer Circuit Positions

Disconnect link in operating position I



Terminal blocks required:
 2 x disconnect/test terminal block 2007-8821
 1 x circuit jumper, orange 2007-8442
 locking covers or interlocking links (option)

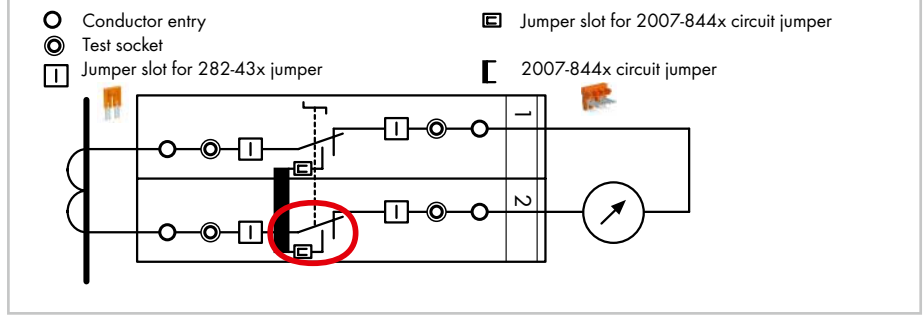

In the operating position, the measurement device is connected to the transformer, the circuit jumper is inserted and the disconnect link is in position I.

Disconnect link in shorting position II

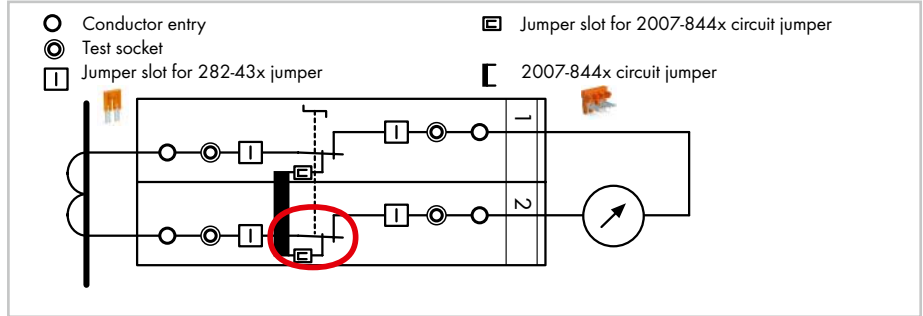

The transformer is **not** disconnected from the measurement device, yet, the shorting path is activated by moving the disconnect link into shorting position II and the transformer is safely shorted.

Test current measurement: Disconnect link in measuring position III

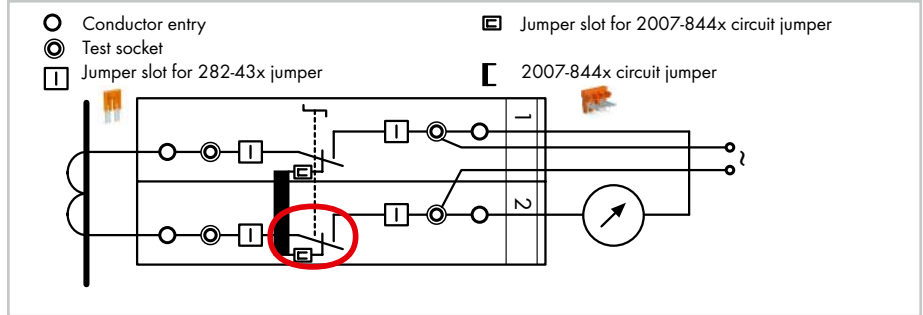

The measuring device is electrically disconnected from the transformer. If required, an external voltage can be applied to the measuring device via the test socket.

Measurement testing (using both test sockets)



Terminal block 1: Disconnect link in operating position I
 Terminal block 2: Disconnect link in measuring position III

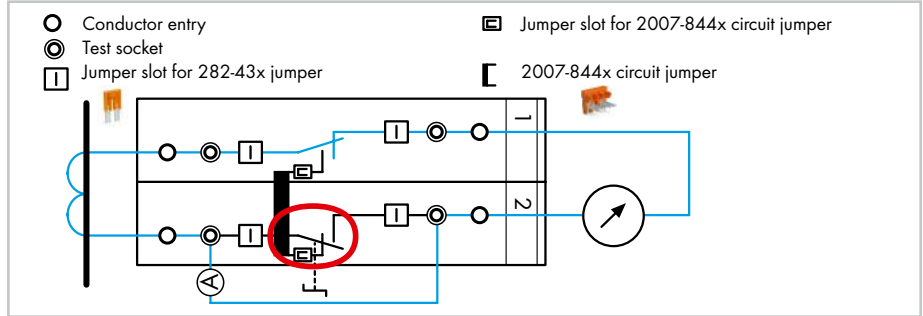

Measurement testing: First insert the reference current meter (A) into the test socket, then move the disconnect link into measurement position III (test current measurement).

TOPJOB® S

Examples for Current Transformer Circuits

Measuring set for a three-phase current transformer



Terminal blocks required:
 6 x disconnect/test terminal block 2007-8821
 3 x circuit jumper, orange 2007-8442
 In addition: interlocking links, locking covers, lock-outs

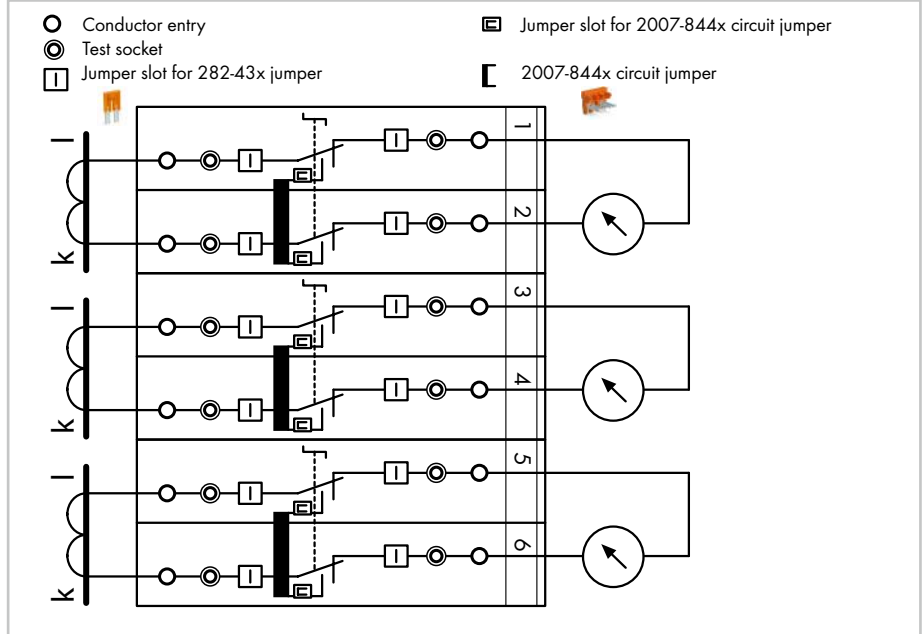

Pairs of disconnect links are interconnected via locking cover or interlocking link. Measurement testing is performed after the interlocking is released.

Measuring set for a three-phase current transformer with 'Y' point



Terminal blocks required:
 6 x disconnect/test terminal block 2007-8821
 1 x circuit jumper, orange 2007-8446
 1 x jumper, orange 282-433
 In addition: interlocking links, locking covers, lock-outs

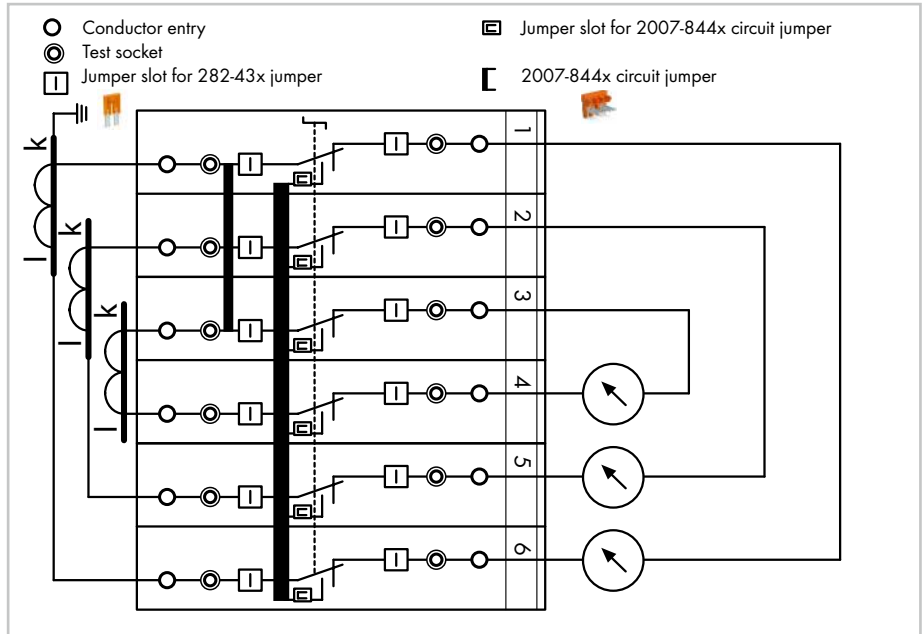

All six disconnect links are interconnected via locking cover or interlocking link.

Interlocking link



Interlocking link mechanically locks multiple links for multi-pole switching applications.

Lock-out seal



A lock-out seal can be used on the disconnect link in operating position I in connection with an end and separator plate (2007-8893 or 2007-8894).

Lock-out



Lock-out prevents accidental operation of disconnect link and snaps into one of two notched positions.

TOPJOB® S

Voltage Transformer Terminal Blocks, 2007-8811 (Light Gray Disconnect Link)

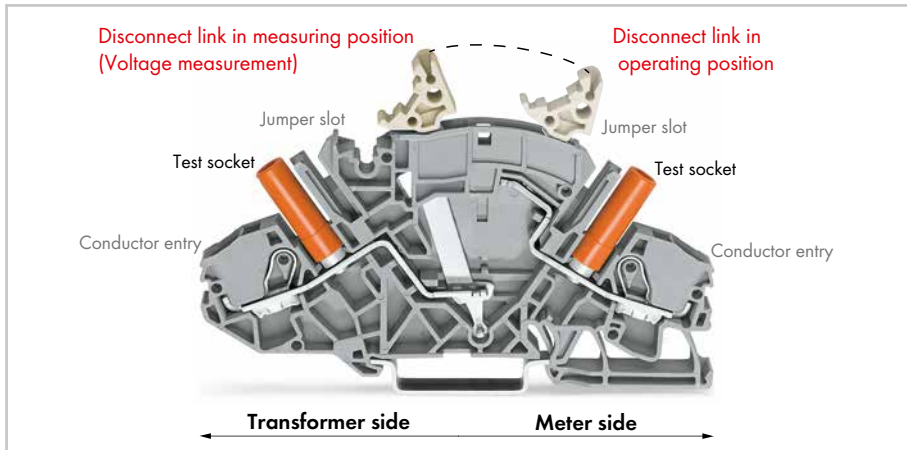

WAGO's TOPJOB® S Voltage Transformer (Disconnect/Test) Terminal Block (2007-8811) is designed for current transformer circuits.

First, disconnect the voltage transformer from the circuit (move disconnect link from operating position to measuring position). Connecting a measuring device via test socket on the meter side can only be performed after disconnection is complete (measuring position).

- For voltage transformer circuits (no circuit jumper slot required as for 2007-8821 Current Transformer Terminal Block)
- Disconnect link provides intuitive and easy operation, as well as exact switching status indication.
- Combines high functionality with compact design (99.6 mm long and 8 mm wide).
- All 2007 Series terminal blocks are rated at 30 A/500 V (IEC) and 300 V (UL).
- With a terminal block width of 8 mm, the maximum cross-section for solid and fine-stranded conductors is 10 mm² (8 AWG) and 6 mm² (10 AWG) for ferruled conductors.
- Touch-proof test sockets for 4 mm Ø test plugs on transformer and meter side.
- Compatible with through and ground conductor terminal blocks of same profile.

Example for voltage transformer testing

Measuring set for single-phase voltage transformer testing



Terminal blocks required:
 1 x disconnect/test terminal block 2007-8811
 1 x through terminal block 2007-8801
 1 x end plate, orange 2007-8892
 In addition: locking cover, lock-out

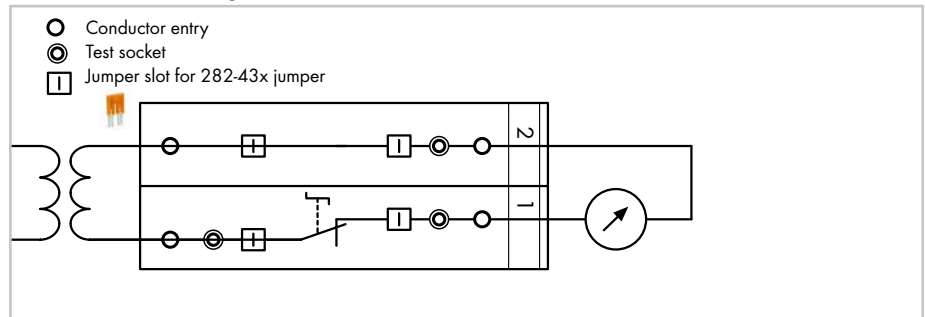

Disconnecting the voltage transformer from the circuit: Move disconnect link from operating position to measuring position.

Voltage measurement: Connecting a measuring device via test socket on the meter side can only be performed after disconnection is complete (measuring position).

Marking



Marking via WMB Multi markers or marking strips.

Commoning



Additional commoning option on the transformer side

Locking cover for disconnect links



Multipole switching via snap-on type, transparent (locking) cover for disconnect links.

TOPJOB® S

Disconnect/Test Terminal Blocks 6 (10) mm² / 30 A, Through and Ground Conductor Terminal Blocks for Current and Voltage Transformer Circuits, 2007 Series

0.5 ... 6 (10) mm ² ①	20 ... 8 AWG	0.5 ... 6 (10) mm ² ①	20 ... 8 AWG
500 V/6 kV/3	300 V, 30 A	500 V/6 kV/3	300 V, 10 A
I _N 30 A		I _N 30 A	
Terminal block width: 8 mm / 0.315 in.		Terminal block width: 8 mm / 0.315 in.	
13 ... 15 mm / 0.55 in.		13 ... 15 mm / 0.55 in.	
② Approvals		② Approvals	

① Conductor range: 0.5 ... 10 mm² "s+f-st"
 Push-in termination: 1 ... 10 mm² "s" and
 1.5 ... 6 mm² "insulated ferrule, 12 mm"

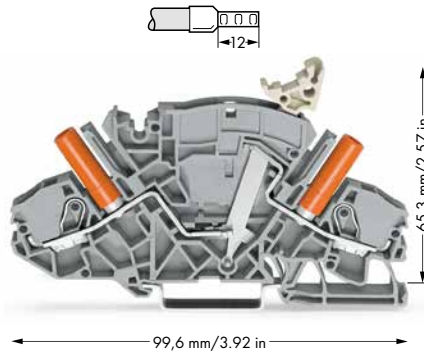
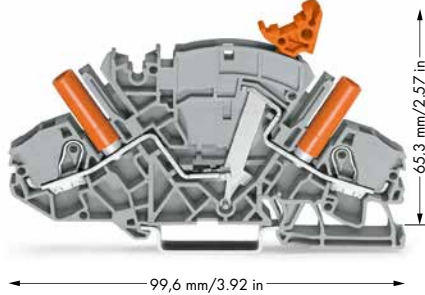

Color	Item No.	Pack. Unit	Color	Item No.	Pack. Unit
	2-conductor disconnect/test terminal block, e.g., current transformer circuits, with circuit jumper slot, with touch-proof test sockets, for 4 mm Ø test plugs			2-conductor disconnect/test terminal block, e.g., voltage transformer circuits, with touch-proof test sockets, for 4 mm Ø test plugs	
	2007-8821	20		2007-8811	20

Accessories, 2007 Series

End and separator plate, 1.5 mm thick, without lock-out seal option	
	2007-8892 50 (5x10)
	2007-8891 50 (5x10)

End and separator plate, 1.5 mm thick, with lock-out seal option	
	2007-8894 50 (5x10)
	2007-8893 50 (5x10)

Lock-out device, for disconnect link	
	2007-8899 100 (5x20)

Locking cover, transparent, mechanically locks multiple links	
	1-pole 282-881 50 (5x10)
	2-pole 282-882 50 (5x10)
	8-pole 282-888 50 (5x10)

Jumper, insulated, I _N 30 A, orange	
	2-way 282-432 50 (5x10)
	3-way 282-433 50 (5x10)
	9-way 282-439 50 (5x10)
	10-way 282-440 50 (5x10)

Jumper with safety lid, insulated, I _N 30 A, orange	
	2-way 282-432/100-000
	3-way 282-433/100-000
	4-way 282-434/100-000
	50 (5x10)

Interlocking link, mechanically locks multiple links, 1 m long	
	transparent 210-254 1

Jumper, special design (other versions upon request), I _N 30 A, orange	
	1-3-5 282-435/011-000
	1-2-4-6 282-436/301-000
	1-3-5-7 282-437/011-000
	1-4-7 282-437/012-000
	1-2-5-8 282-438/300-000
	1-4-7-8 282-438/301-000
	1-3-5-7-9 282-439/011-000
	50 (5x10)

Protective warning marker, with high-voltage symbol, black, for 5 terminal blocks	
	2006-115 100 (4x25)

WMB Multi marking system, plain 10 strips with 10 markers per card, for 5 ... 17.5 mm terminal block width	
	793-501 5

Marking strip, plain, 11 mm wide, 50 m roll	
	2009-110 1

Banana plugs, only for safety extra-low voltage (42 V)	
	215-212 50
	215-311 50
For additional colors, see page 262.	

Operating tool with a partially insulated shaft, type 2, (5.5 x 0.8) mm blade	
	210-721 1

Item-Specific Accessories

Circuit jumper, insulated, I _N 30 A, orange	
	2-way 2007-8442 50 (5x10)
	3-way 2007-8443 50 (5x10)
	4-way 2007-8444 50 (5x10)
	5-way 2007-8445 50 (5x10)
	6-way 2007-8446 50 (5x10)
	7-way 2007-8447 50 (5x10)
	8-way 2007-8448 50 (5x10)

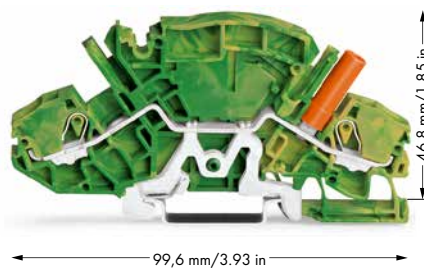
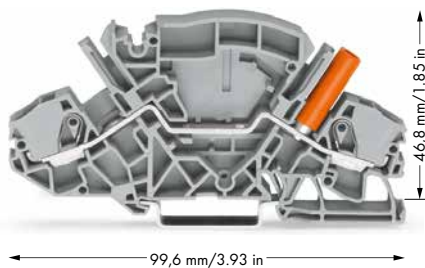

Color	Item No.	Pack. Unit	Color	Item No.	Pack. Unit
	2-conductor through terminal block, with touch-proof test socket, for 4 mm Ø test plug			2-cond. ground conductor terminal block, with touch-proof test socket, for 4 mm Ø test plug	
	2007-8801	20		2007-8807	20

② For all approvals and corresponding ratings, visit www.wago.com.

For technical information and abbreviations, see technical section.

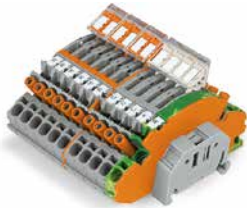
TOPJOB® S**PUSH-IN CAGE CLAMP®****Terminal Block Assemblies for Current and Voltage Transformers****2007 Series**

Item No. for Set: 2007-8873	Designation: Current and Voltage Transformer Terminal Block Assembly	Quantity
249-117	Screwless end stop, 10 mm wide	2
282-882	Locking cover, mechanically locks multiple links, 2-pole	3
282-884	Locking cover, mechanically locks multiple links, 4-pole	1
2007-8442	Circuit jumper, insulated, 2-way	3
2007-8807	2-cond. ground conductor terminal block, with touch-proof test socket, for 4 mm Ø test plug	1
2007-8811	2-conductor disconnect/test terminal block, with touch-proof test sockets, for 4 mm Ø test plugs	4
2007-8821	2-conductor disconnect/test terminal block, with touch-proof test sockets, for 4 mm Ø test plugs	6
2007-8892	End and separator plate, 1.5 mm thick, without lock-out seal option	2
2009-135	WMB Inline, plain, 8,000 WMB markers (5 mm) per roll	21 markers
282-435/011-000	Jumper, insulated, 1-3-5	1
Assembly width incl. end stop: 11.2 cm		

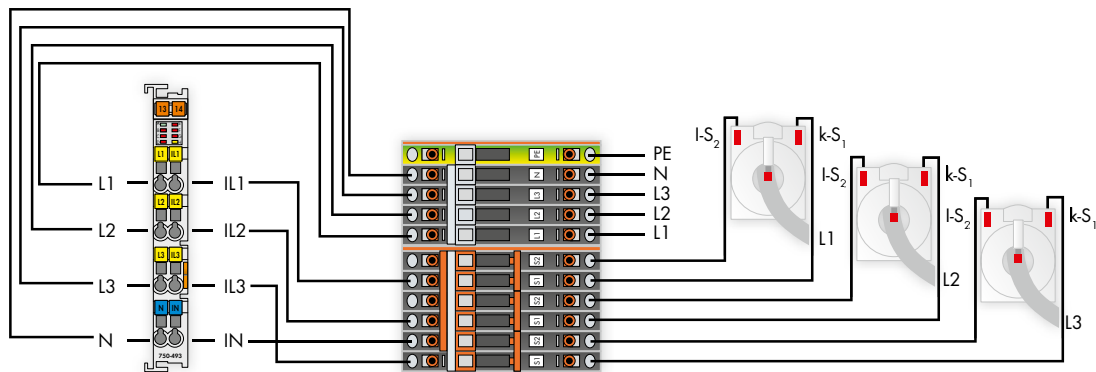

3-Phase Power Measurement Module
750 Series

Terminal Block Assembly for
Current and Voltage Transformers
2007 Series

Current Transformers
855 Series





Item No. for Set: 2007-8876	Designation: Current Transformer Terminal Block Assembly	Quantity
249-117	Screwless end stop, 10 mm wide	2
282-369	Collective jumper carrier, for DIN-35 rail, compatible with jumpers for transverse switching (282-811) and longitudinal switching disconnect (282-821) terminal blocks	1
282-882	Locking cover, mechanically locks multiple links, 2-pole	3
2007-8442	Circuit jumper, insulated, 2-way	3
2007-8821	2-conductor disconnect/test terminal block, with touch-proof test sockets, for 4 mm Ø test plugs	6
2007-8892	End and separator plate, 1.5 mm thick, without lock-out seal option	1
2009-135	WMB Inline, plain, 8,000 WMB markers (5 mm) per roll	12 markers
282-435/011-000	Jumper, insulated, 1-3-5	1
Assembly width incl. end stop: 8.5 cm		

TOPJOB® S

Double-Deck Disconnect, Carrier and Fuse Terminal Blocks 2.5 (4) mm²

2002 Series

0.25 ... 2.5 (4) mm ² ①	22 ... 12 AWG	0.25 ... 2.5 (4) mm ² ①	22 ... 12 AWG
400 V/6 kV/3 ②	300 V, 20 A ③	250 V/6 kV/3 ②	30 V, 6.3 A ③
I _N 16 A		I _N 6.3 A	
Terminal block width: 5.2 mm / 0.205 in.		Terminal block width: 6.2 mm / 0.244 in.	
 10 ... 12 mm / 0.43 in.		 10 ... 12 mm / 0.43 in.	
④ Approvals		④ Approvals	

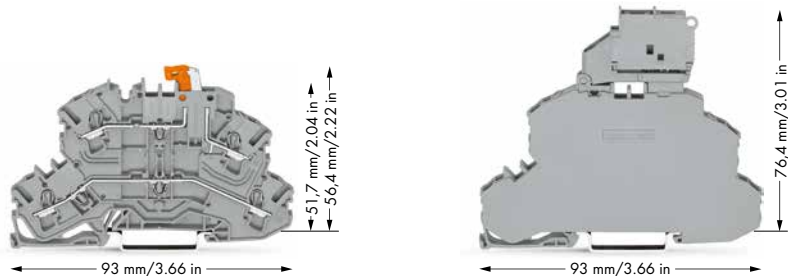

- ① Conductor range: 0.25 ... 4 mm² "s+f-st"
Push-in termination: 0.75 ... 4 mm² "s"
and 0.75 ... 2.5 mm² "insulated ferrules, 12 mm"
- ② 400 V = Rated voltage
6 kV = Rated impulse voltage
3 = Pollution degree
- ③ Due to the 6.2 mm width of fuse disconnect terminal blocks with a pivoting fuse holder, 2004 Series Push-In Type Jumper Bars must be used.

Color	Item No.	Pack. Unit	Color	Item No.	Pack. Unit	Accessories, 2002 Series
Double-deck disconnect terminal block, with movable knife disconnect, gray housing <input type="radio"/> L/L 2002-2671 50 <input type="radio"/> N/L 2002-2672 50			Double-deck fuse disconnect terminal block with pivoting fuse holder, through/fuse terminal block, for 5 x 20 mm miniature metric fuse, without blown fuse indication, nominal voltage/current given by the fuse <input type="radio"/> L/L 2002-2611 25 <input type="radio"/> N/L 2002-2612 25			Double-deck marker carrier, pivoting  2002-121 50 (2x25)
Double-deck carrier terminal block, upper-deck base, gray housing <input type="radio"/> L/L 2002-2661 50 <input type="radio"/> N/L 2002-2662 50			Double-deck fuse disconnect terminal block with pivoting fuse holder, through/fuse terminal block, for 5 x 20 mm miniature metric fuse, with blown fuse indication by LED, gray, nominal voltage/current given by LED or fuse; Leakage current in case of blown fuse: LED 2 mA <input type="radio"/> 12 ... 30 V 2002-2611/1000-541 25 <input type="radio"/> 30 ... 65 V 2002-2611/1000-542 25 <input type="radio"/> 230 V 2002-2611/1000-836 25			Insulation stop, 5 pcs/strip <input type="radio"/> 2002-171 0.25-0.5 mm ² <input type="radio"/> 2002-172 0.75-1 mm ² 200 (8x25)
Double-deck carrier terminal block, upper-deck base, gray housing <input type="radio"/> PE/L 2002-2667 50			Item-Specific Accessories End and intermediate plate, 1 mm thick <input type="radio"/> 2002-2692 100 (4x25) <input type="radio"/> 2002-2691 100 (4x25)			Test plug, with 500 mm cable <input type="radio"/> 2 mm Ø 210-136 50 <input type="radio"/> 2.3 mm Ø 210-137 50
Item-Specific Accessories Adjacent jumper for continuous commoning, insulated, I _N 25 A, light gray 2-way 2002-400 100 (4x25) 1 to 3 2002-423 100 (4x25)			Item-Specific Accessories End plate for fuse terminal blocks, 2 mm thick <input type="radio"/> 2002-1092 100 (4x25) <input type="radio"/> 2002-1091 100 (4x25)			Marking strip, plain, 11 mm wide, 50 m roll <input type="radio"/> 2009-110 1
Push-in type jumper bar, insulated, I _N 25 A, light gray 2-way 2002-402 200 (8x25) : : 10-way 2002-410 100 (4x25) <input type="radio"/> .../000-005 <input type="radio"/> .../000-006			Push-in type jumper bar, insulated, I _N 32 A, light gray 2-way 2004-402 200 (8x25) 3-way 2004-403 200 (8x25) : : 10-way 2004-410 100 (4x25)			Operating tool, 3.5 mm and 2.5 mm blades <input type="radio"/> 2009-309 1
Push-in type jumper bar, insulated, I _N 25 A, light gray 1 to 3 2002-433 200 (8x25) : : 1 to 10 2002-440 100 (4x25)			Push-in type jumper bar, insulated, I _N 32 A, light gray 1 to 3 2004-433 200 (8x25) : : 1 to 10 2004-440 100 (4x25)			Operating tool with a partially insulated shaft, type 2, (3.5 x 0.5) mm blade <input type="radio"/> 210-720 1
Double-deck vertical jumper, insulated, I_N 24 A <input type="radio"/> 2002-492 <input type="radio"/> 2002-492/000-012 100 (4x25)			Double-deck vertical jumper, insulated, I_N 24 A <input type="radio"/> 2002-492 <input type="radio"/> 2002-492/000-012 100 (4x25)			Diode module, 5.2 mm wide, gray Circuit I 2002-800/1000-411 100 Circuit II 2002-800/1000-410 100
Protective warning marker, ⑤ with high-voltage symbol, black, for 5 terminal blocks <input type="radio"/> 2002-115 100 (4x25)			Protective warning marker, ⑤ with high-voltage symbol, black, for 5 terminal blocks <input type="radio"/> 2004-115 100 (4x25)			LED module, 5.2 mm wide, gray 12 ... 30 V 2002-800/1000-541 100 30 ... 65 V 2002-800/1000-542 100 230 V 2002-800/1000-836 100
						Fuse plugs, see page 48 Empty component plug housings, see page 236

④ For all approvals and corresponding ratings, visit www.wago.com.

⑤ Protective warning markers must be applied individually.



TOPJOB® S

Double-Deck Disconnect Terminal Blocks 2.5 (4) mm²

2002 Series

PUSH-IN CAGE CLAMP®

1

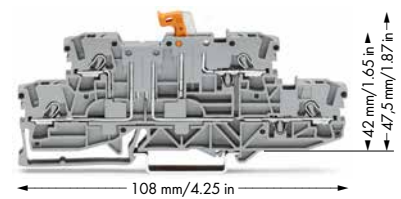
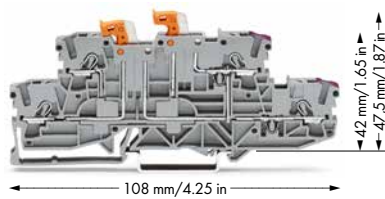
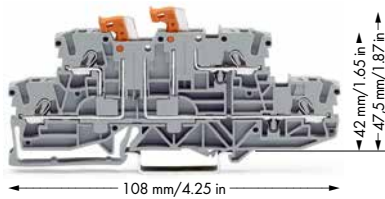

0.25 ... 2.5 (4) mm ² ① 22 ... 12 AWG 400 V/6 kV/3 I _N 16 A Terminal block width: 5.2 mm / 0.205 in.  10 ... 12 mm / 0.43 in. ④ Approvals	0.25 ... 2.5 (4) mm ² ① 22 ... 12 AWG 400 V/6 kV/3 I _N 16 A Terminal block width: 5.2 mm / 0.205 in.  10 ... 12 mm / 0.43 in. ④ Approvals	0.25 ... 2.5 (4) mm ² ① 22 ... 12 AWG 400 V/6 kV/3 I _N 16 A Terminal block width: 5.2 mm / 0.205 in.  10 ... 12 mm / 0.43 in. ④ Approvals
---	---	---

① Conductor range: 0.25 ... 4 mm² "s+f-st"
 Push-in termination: 0.75 ... 4 mm² "s" and
 0.75 ... 2.5 mm² "insulated ferrule, 12 mm"



Color	Item No.	Pack. Unit	Color	Item No.	Pack. Unit	Color	Item No.	Pack. Unit
4-conductor, double-deck, double-disconnect terminal block			4-conductor, double-deck, double-disconnect terminal block,			4-conductor, double-deck disconnect terminal block,		
● gray	2002-2951	50	lower and upper decks internally commoned on right			● gray	2002-2971	50
● blue	2002-2954	50	side, violet marking			● blue	2002-2974	50
● gray N/L	2002-2952	50	● gray	2002-2958	50	● gray N/L	2002-2972	50
			● blue	2002-2959	50			

Item-Specific Accessories

End and intermediate plate, 1 mm thick  <ul style="list-style-type: none"> ● 2002-2992 100 (4x25) ○ 2002-2991 100 (4x25) 	End and intermediate plate, 1 mm thick  <ul style="list-style-type: none"> ● 2002-2992 100 (4x25) ○ 2002-2991 100 (4x25) 	End and intermediate plate, 1 mm thick  <ul style="list-style-type: none"> ● 2002-2992 100 (4x25) ○ 2002-2991 100 (4x25)
---	---	---

Accessories, 2002 Series



Appropriate marking systems: **WMB/Marking Strips/WMB Inline**

Adjacent jumper for continuous commoning, insulated, I _N 25 A, light gray 2-way 2002-400 100 (4x25) 1 to 3 2002-423 100 (4x25)	Push-in type jumper bar, insulated, I _N 25 A, light gray 2-way 2002-402 200 (8x25) : : 10-way 2002-410 100 (4x25) ● .../000-005 ● .../000-006	Push-in type jumper bar, insulated, I _N 25 A, light gray 1 to 3 2002-433 200(8x25) : : 1 to 10 2002-440 100(4x25)
Staggered jumper, insulated, I _N 25 A, light gray 2-way 2002-472 100 (4x25) 3-way 2002-473 100 (4x25) : : 12-way 2002-482 50 (2x25)	Insulation stop, 5 pcs/strip ○ 2002-171 0.25-0.5 mm ² ● 2002-172 0.75-1 mm ² 200 (8x25)	Modular TOPJOB® S connector, can be snapped together, I _N 24 A, for jumper con- tact slot ○ 2002-511 100(4x25)
Test plug adapter, for 4 mm Ø test plug 2009-174 100 (4x25) Testing tap, for max. 2.5 mm² 2009-182 100 (4x25)	Banana plugs, only for safety extra-low voltage (42 V) ● 215-212 50 ● 215-311 50 For additional colors, see page 262.	Spacer module, can be snapped together ○ 2002-549 100(4x25)
Protective warning marker, with high-voltage symbol, for 5 terminal blocks ● 2002-115 100 (4x25)	Marking strips, plain 11 mm wide, 50 m roll ○ 2009-110 1	Operating tool with a partially insulated shaft, type 2, (3.5 x 0.5) mm blade 210-720 1
		Test plug, with 500 mm cable ● 2 mm Ø 210-136 50 ● 2.3 mm Ø 210-137 50

TOPJOB® S





Diode and LED Terminal Blocks 2.5 (4) mm²

2002 Series

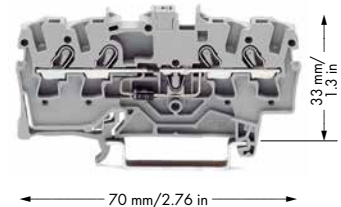
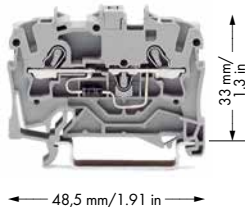
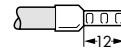

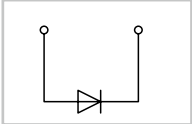
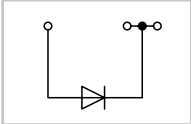
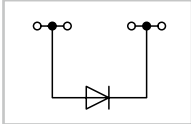
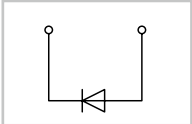
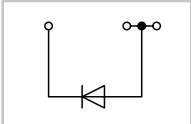
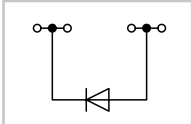
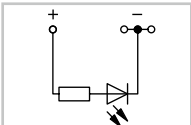
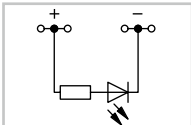
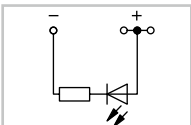
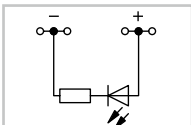
<p>0.25 ... 2.5 (4) mm² ① 22 ... 12 AWG U_N 250 V; U_{RM} 1000 V 1N4007 – 0.5 A continuous current</p> <p>Terminal block width: 5.2 mm / 0.205 in.  10 ... 12 mm / 0.43 in.</p> <p>④ Approvals</p>	<p>0.25 ... 2.5 (4) mm² ① 22 ... 12 AWG ② U_N 250 V; U_{RM} 1000 V 1N4007 – 0.5 A continuous current ③ 24 VDC / I_F 0.025 A max.</p> <p>Terminal block width: 5.2 mm / 0.205 in.  10 ... 12 mm / 0.43 in.</p> <p>④ Approvals</p>	<p>0.25 ... 2.5 (4) mm² ① 22 ... 12 AWG ② U_N 250 V; U_{RM} 1000 V 1N4007 – 0.5 A continuous current ③ 24 VDC / I_F 0.025 A max.</p> <p>Terminal block width: 5.2 mm / 0.205 in.  10 ... 12 mm / 0.43 in.</p> <p>④ Approvals</p>
---	--	--

① Conductor range: 0.25 ... 4 mm² "s+f-st"
 Push-in termination: 0.75 ... 4 mm² "s" and
 0.75 ... 2.5 mm² "insulated ferrule, 12 mm"







Item No.	Pack. Unit	Item No.	Pack. Unit	Item No.	Pack. Unit
	2-conductor diode terminal block with 1N4007 diode 2002-1211/1000-410 100		② 3-conductor diode terminal block with 1N4007 diode 2002-1311/1000-410 100		② 4-conductor diode terminal block with 1N4007 diode 2002-1411/1000-410 100
	2-conductor diode terminal block with 1N4007 diode 2002-1211/1000-411 100		② 3-conductor diode terminal block with 1N4007 diode 2002-1311/1000-411 100		② 4-conductor diode terminal block with 1N4007 diode 2002-1411/1000-411 100
			③ 3-conductor LED terminal block with red LED, 24 VDC 2002-1321/1000-434 100		③ 4-conductor LED terminal block with red LED, 24 VDC 2002-1421/1000-434 100
			③ 3-conductor LED terminal block with red LED, 24 VDC 2002-1321/1000-413 100		③ 4-conductor LED terminal block with red LED, 24 VDC 2002-1421/1000-413 100
	Through terminal block of same profile 2002-1201 100		Through terminal block of same profile 2002-1301 100		Through terminal block of same profile 2002-1401 100

Item-Specific Accessories

<p>End and intermediate plate, 0.8 mm thick</p>  <ul style="list-style-type: none"> ② 2002-1292 100 (4x25) ① 2002-1291 100 (4x25) 	<p>End and intermediate plate, 0.8 mm thick</p>  <ul style="list-style-type: none"> ② 2002-1392 100 (4x25) ① 2002-1391 100 (4x25) 	<p>End and intermediate plate, 0.8 mm thick</p>  <ul style="list-style-type: none"> ② 2002-1492 100 (4x25) ① 2002-1491 100 (4x25)
--	--	--

Accessories, 2002 Series Appropriate marking systems: WMB/Marking Strips/WMB Inline

<p>Adjacent jumper for continuous commoning, insulated, I_N 25 A, light gray</p>  <ul style="list-style-type: none"> 2-way 2002-400 100 (4x25) 1 to 3 2002-423 100 (4x25) 	<p>Push-in type jumper bar, insulated, I_N 25 A, light gray</p>  <ul style="list-style-type: none"> 2-way 2002-402 200 (8x25) 3-way 2002-403 200 (8x25) 4-way 2002-404 200 (8x25) : : 10-way 2002-410 100 (4x25) 	<p>Staggered jumper, insulated, I_N 25 A, light gray</p>  <ul style="list-style-type: none"> 2-way 2002-472 100 (4x25) 3-way 2002-473 100 (4x25) 4-way 2002-474 100 (4x25) 5-way 2002-475 50 (2x25) : : 12-way 2002-482 50 (2x25)
<p>Push-in type jumper bar, insulated, I_N 25 A, light gray</p>  <ul style="list-style-type: none"> 1 to 3 2002-433 200 (8x25) : : 1 to 10 2002-440 100 (4x25) 	<p>② .../000-005</p> <p>③ .../000-006</p>	

④ For all approvals and corresponding ratings, visit www.wago.com.



For technical information and abbreviations, see technical section.

TOPJOB® S

PUSH-IN CAGE CLAMP®

Double- and Triple-Deck Diode Terminal Blocks

Double- and Triple-Deck LED Terminal Blocks, 2.5 (4) mm², 2002 Series

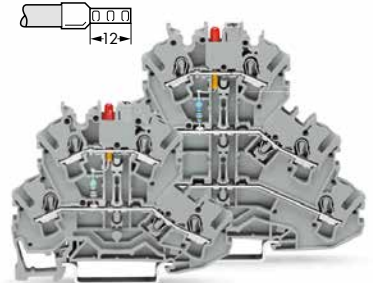
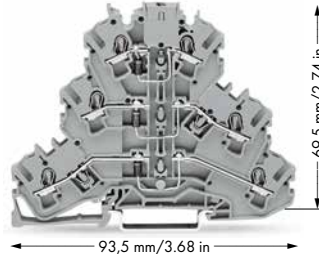
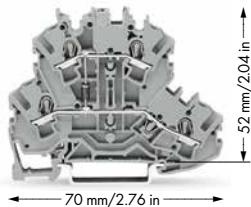

0.25 ... 2.5 (4) mm ² ① 22 ... 12 AWG U _N 250 V; U _{RM} 1000 V 1N4007 – 0.5 A continuous current Terminal block width: 5.2 mm / 0.205 in.  10 ... 12 mm / 0.43 in. ④ Approvals	0.25 ... 2.5 (4) mm ² ① 22 ... 12 AWG U _N 250 V; U _{RM} 1000 V 1N4007 – 0.5 A continuous current Terminal block width: 5.2 mm / 0.205 in.  10 ... 12 mm / 0.43 in. ④ Approvals	0.25 ... 2.5 (4) mm ² ① 22 ... 12 AWG 24 VDC I _f 25 mA max. Terminal block width: 5.2 mm / 0.205 in.  10 ... 12 mm / 0.43 in. ④ Approvals
---	---	---

① Conductor range: 0.25 ... 4 mm² "s+f-st"
 Push-in termination: 0.75 ... 4 mm² "s" and
 0.75 ... 2.5 mm² "insulated ferrule, 12 mm"









Item No.	Pack. Unit	Item No.	Pack. Unit	Item No.	Pack. Unit
	Double-deck diode terminal block with 1N4007 diode (I) 2002-2211/1000-410 50		Double-deck diode terminal block with 1N4007 diode (II) 2002-2211/1000-411 50		Triple-deck diode terminal block with 1N4007 diode (I) 2002-3211/1000-410 50
	Double-deck diode terminal block with 2 1N4007 diodes (I) 2002-2214/1000-492 50		Double-deck diode terminal block with 2 1N4007 diodes (II) 2002-2214/1000-491 50		Triple-deck diode terminal block with 1N4007 diode (II) 2002-3212/1000-673 50
	Double-deck diode terminal block with 2 1N4007 diodes (I) 2002-2213/1000-487 50		Double-deck diode terminal block with 2 1N4007 diodes (II) 2002-2213/1000-488 50		Triple-deck diode terminal block with 1N4007 diode (III) 2002-3211/1000-675 50
	Double-deck diode terminal block with 2 1N4007 diodes (I) 2002-2214/1000-489 50		Double-deck diode terminal block with 2 1N4007 diodes (II) 2002-2214/1000-490 50		Triple-deck diode terminal block with 1N4007 diode (I) 2002-3211/1000-676 50
					Triple-deck diode terminal block with red LED, 24 VDC 2002-2221/1000-434 50
					Double-deck diode terminal block with red LED, 24 VDC 2002-2221/1000-413 50
					Triple-deck diode terminal block with red LED, 24 VDC 2002-3221/1000-434 50
					Triple-deck diode terminal block with red LED, 24 VDC 2002-3221/1000-413 50
	Through terminal block of same profile 2002-2201 100		Through terminal block of same profile 2002-3201 100		Through terminal block with same profile Double-deck terminal block 2002-2201 Triple-deck terminal block 2002-3201

Item-Specific Accessories

End and intermediate plate, 0.8 mm thick  ● 2002-2292 100 (4x25) ○ 2002-2291 100 (4x25)	End and intermediate plate, 0.8 mm thick  ● 2002-3292 100 (4x25) ○ 2002-3291 100 (4x25)	End and intermediate plate, 0.8 mm thick Double-deck terminal block ● 2002-2292 ○ 2002-2291 Triple-deck terminal block ● 2002-3292 ○ 2002-3291
---	---	---

Accessories, 2002 Series

Appropriate marking systems: **WMB/Marking Strips/WMB Inline**

Insulation stop, 5 pcs/strip  ○ 2002-171 0.25–0.5 mm ² ● 2002-172 0.75–1 mm ² 200 (8x25)	Test plug adapter, for 4 mm Ø test plug  2009-174 100 (4x25) Testing tap, for max. 2.5 mm² 2009-182 100 (4x25)	Operating tool with a partially insulated shaft, type 2, (3.5 x 0.5) mm blade  210-720 1
Insulated ferrules, extra long, for TOPJOB® S terminal blocks, see page 259 	Banana plugs, only for safety extra-low voltage (42 V)  ● 215-212 50 ● 215-311 50 For additional colors, see page 262.	WMB Multi marking system, plain, 10 strips with 10 markers per card, stretchable from 5 ... 5.2 mm  ○ 793-5501 5

Please find the entire product range in our Full Line Catalog. For additional information, visit www.wago.com.

Sensor and Actuator Terminal Blocks – Description and Handling –

Commoning (potential level)

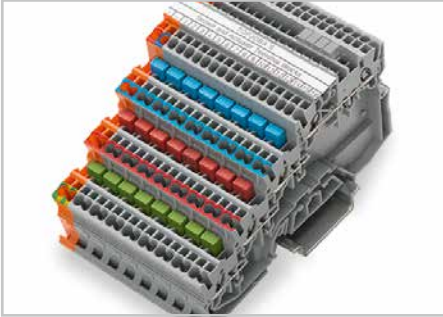

Continuous commoning in the potential level via push-in type jumper bars for even pole numbers.

Ground commoning



For sensor and actuator terminal blocks without ground connection to the DIN-rail, the ground connection can be performed by commoning to the terminal block with a ground foot.

Commoning and testing (signal level)

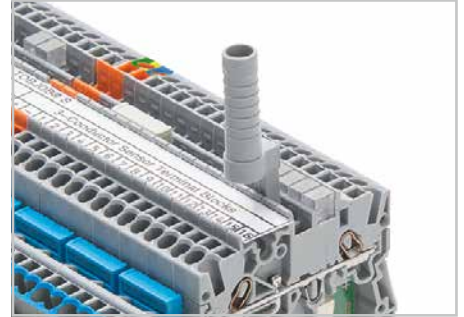

Commoning the signal level with push-in type jumper bars. Models with an LED can only be commoned in one jumper slot. TOPJOB® S Test Plug Adapter can be used in all jumper slots.

Power supply

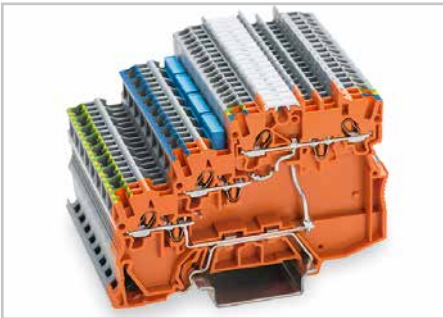

Orange supply terminal block of same profile with a power supply option from both the cabinet and sensor sides

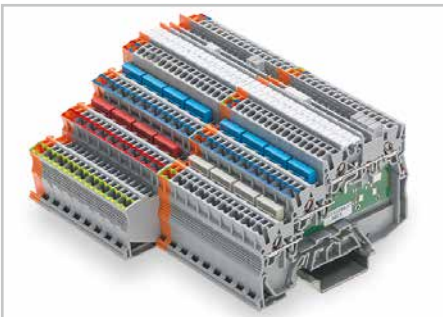

Terminal block assembly with 4-conductor sensor terminal blocks and 3-conductor actuator terminal blocks

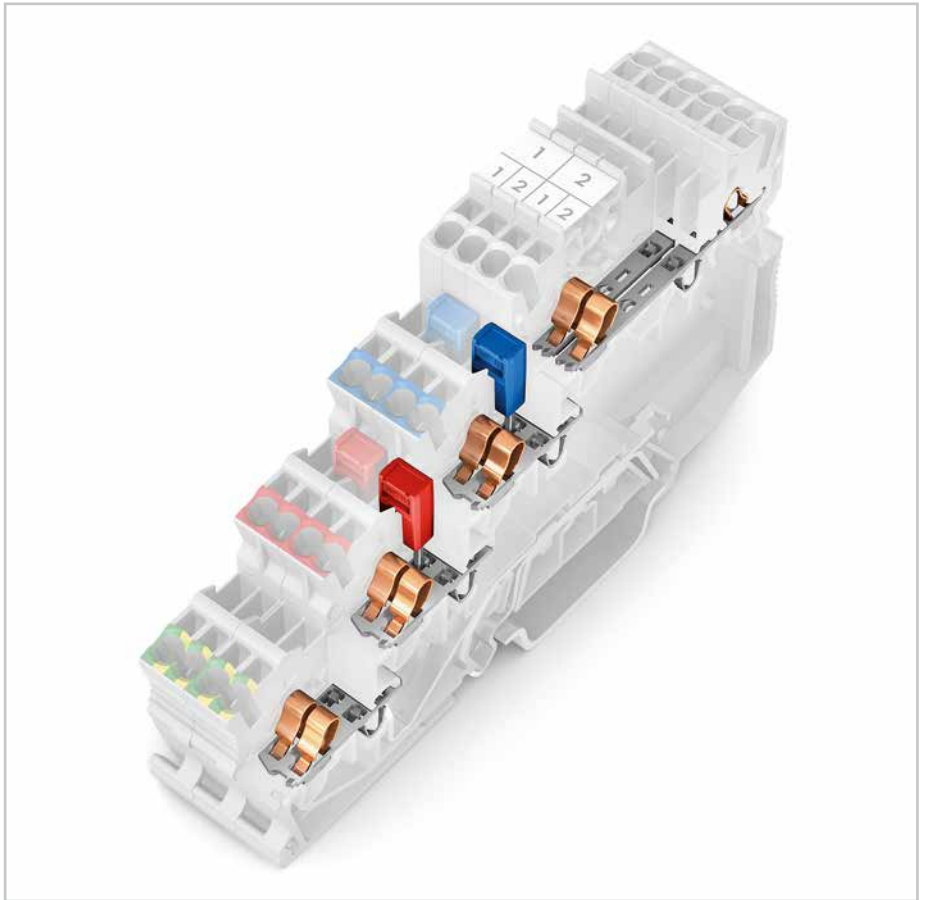

Upper level: two independent signal pathways in 3.5 mm spacing per pole, with dual jumper slot
Lower levels: two interconnected potential clamping units, with a single jumper slot, can be commoned in both directions

Marking

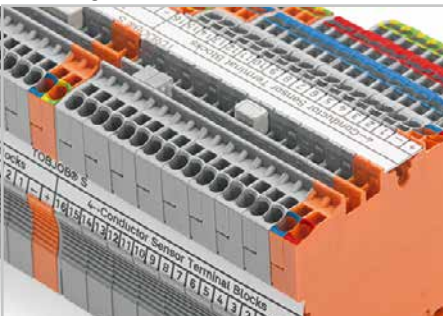

Marking strips (2009-110) or 3.5 mm WMB markers (793-35xx), marking from the top or the side, additional marking option via marker carrier



3-conductor sensor LED terminal block with a connected sensor

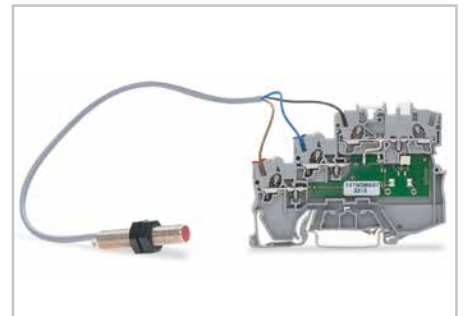

For information on Push-in CAGE CLAMP® connection, see page 14.

TOPJOB® S

3-Conductor Sensor Terminal Blocks 1 (1.5) mm²

2000 Series

PUSH-IN CAGE CLAMP®

0.14 ... 1 (1.5) mm ² ① 250 V/4 kV/3 ② I _N 13.5 A	24 ... 16 AWG 300 V, 10 A	0.14 ... 1 (1.5) mm ² ① 24 VDC I _N 13.5 A	24 ... 16 AWG 24 VDC, 10 A
Terminal block width: 7 mm / 0.276 in. ③ 9 ... 11 mm / 0.39 in.		Terminal block width: 7 mm / 0.276 in. ③ 9 ... 11 mm / 0.39 in.	
④ Approvals		④ Approvals	

- ① Conductor range: 0.14 ... 1.5 mm² "s+f-st"
Push-in termination: 0.5 ... 1.5 mm² "s"
and 0.5 ... 0.75 mm²
"insulated ferrules, 10 mm"
- ② 250 V = Rated voltage
4 kV = Rated impulse voltage
3 = Pollution degree
(see Full Line Catalog)
- ③ 3.5 mm spacing per signal (2 x 3.5 mm = 7 mm)
- ④ For all approvals and corresponding ratings, visit www.wago.com.
- ⑤ See application notes in our Full Line Catalog.

1

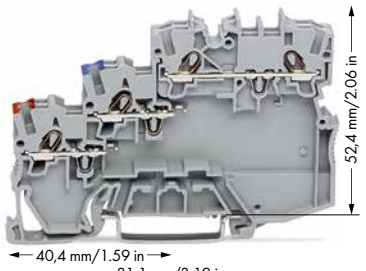

40,4 mm/1.59 in
81,1 mm/3.19 in
52,4 mm/2.06 in

2000-5311

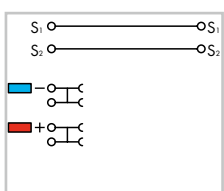

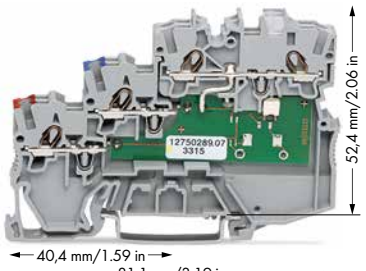

40,4 mm/1.59 in
81,1 mm/3.19 in
52,4 mm/2.06 in

2000-5311/1102-950

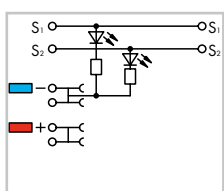

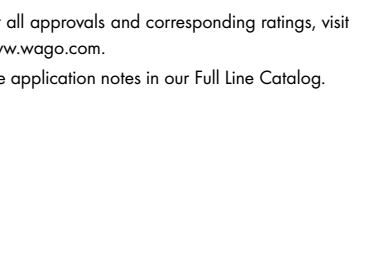

40,4 mm/1.59 in
81,1 mm/3.19 in
52,4 mm/2.06 in

2000-5311/1101-951

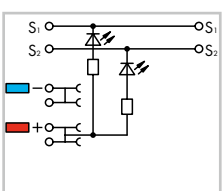

Note:
The double spacing per pole of this terminal block series maximizes connectivity. For example **ten** sensors may be connected using only **five** sensor terminal blocks plus power supply terminal block.

Color	Item No.	Pack. Unit	Color	Item No.	Pack. Unit
3-conductor sensor terminal block			3-conductor sensor LED terminal block, for PNP (high-side) switching sensors, yellow LED		
○ gray	2000-5311	50	○ gray	2000-5311/1102-950	50
3-conductor sensor LED terminal block, for NPN (low-side) switching sensors, yellow LED					
○ gray	2000-5311/1101-951	50			

Accessories for 3-Conductor Terminal Blocks

Appropriate marking systems:
WMB/Marking Strips/WMB Inline

End and intermediate plate, 1 mm thick, for 3-conductor terminal blocks	
○	2000-5391 100 (4x25)
Push-in type jumper bar, insulated,	
⑤	I _N 14 A, light gray
	2-way 2000-402 200 (8x25)
	3-way 2000-403 200 (8x25)
	⋮
	10-way 2000-410 100 (4x25)
● .../000-005	● .../000-006
Push-in type jumper bar, insulated,	
	I _N 14 A, light gray
	1 to 3 2000-433 200 (8x25)
	1 to 4 2000-434 200 (8x25)
	⋮
	1 to 10 2000-440 100 (4x25)
Double-deck marker carrier,	
	pivoting
○	2000-121 50 (2x25)
Marking strip, plain,	
	11 mm wide, 50 m roll
○	2009-110 1
WMB Multi marking system, plain,	
	10 strips with 10 markers per card, for 3.5 mm terminal block width
○	793-3501 5
Operating tool with a partially insulated shaft,	
	type 1, (2.5 x 0.4) mm blade
○	210-719 1
Insulated ferrules, extra long,	
	for TOPJOB® S terminal blocks, see page 259

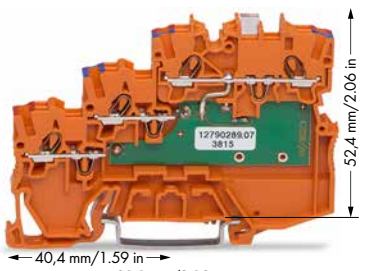

40,4 mm/1.59 in
81,1 mm/3.19 in
52,4 mm/2.06 in

2000-5372

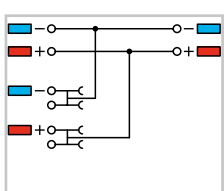

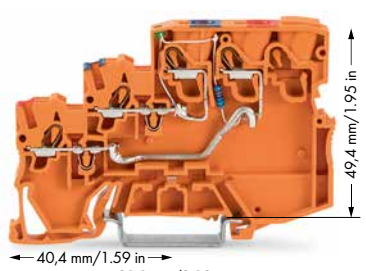

40,4 mm/1.59 in
81,1 mm/3.19 in
52,4 mm/2.06 in

2000-5372/1102-953

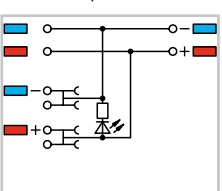

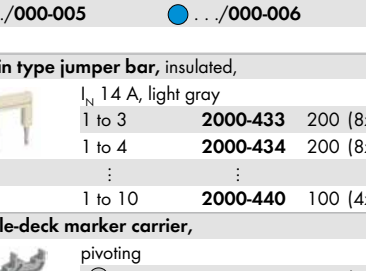

40,4 mm/1.59 in
81,1 mm/3.19 in
49,4 mm/1.95 in

2000-5352/1102-953

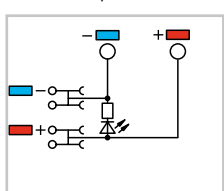

Color	Item No.	Pack. Unit	Color	Item No.	Pack. Unit
3-conductor sensor supply terminal block, max. 250 V,			3-conductor sensor supply terminal block, max. 250 V, control panel side: 2.5 (4) mm², max. 28 A		
● orange	2000-5372	15	● orange	2000-5352	15
3-conductor sensor LED supply terminal block, 24 VDC, green LED			3-conductor sensor LED supply terminal block, 24 VDC, green LED, control panel side: 2.5 (4) mm², max. 28 A		
● orange	2000-5372/1102-953	15	● orange	2000-5352/1102-953	15

For technical information and abbreviations, see technical section.

TOPJOB® S

4-Conductor Sensor Terminal Blocks 1 (1.5) mm²

2000 Series

PUSH-IN CAGE CLAMP®

0.14 ... 1 (1.5) mm ² ① 250 V/4 kV/3 ② I _N 13.5 A	24 ... 16 AWG 300 V, 10 A	0.14 ... 1 (1.5) mm ² ① 24 VDC I _N 13.5 A	24 ... 16 AWG 24 VDC, 10 A
Terminal block width: 7 mm / 0.276 in. ③ 9 ... 11 mm / 0.39 in.		Terminal block width: 7 mm / 0.276 in. ③ 9 ... 11 mm / 0.39 in.	
④ Approvals		④ Approvals	

- ① Conductor range: 0.14 ... 1.5 mm² "s+f-st"
Push-in termination: 0.5 ... 1.5 mm² "s"
and 0.5 ... 0.75 mm² "insulated ferrules, 10 mm"
- ② 250 V = Rated voltage
4 kV = Rated impulse voltage
3 = Pollution degree
(see Full Line Catalog)
- ③ 3.5 mm spacing per signal (2 x 3.5 mm = 7 mm)
- ④ For all approvals and corresponding ratings, visit www.wago.com.
- ⑤ See application notes in our Full Line Catalog.
- ⑥ Ground connection via commoning to terminal blocks with ground foot

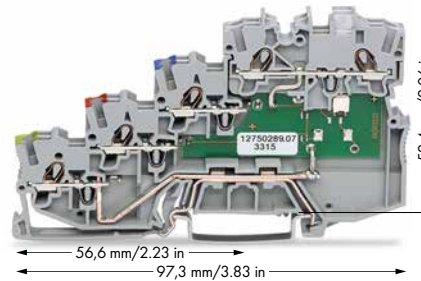
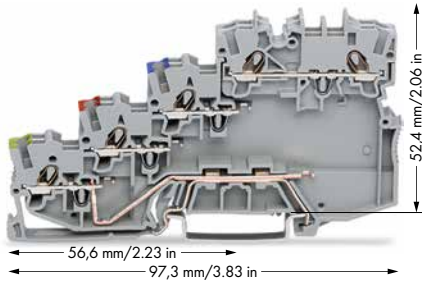

2000-5417

2000-5410

2000-5417/1102-950

2000-5417/1101-951

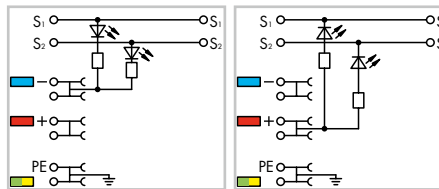
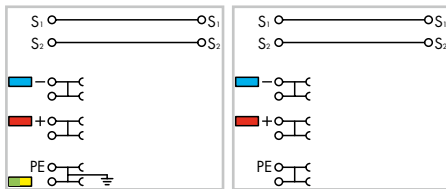

Note:
The double spacing per pole of this terminal block series maximizes connectivity. For example **ten** sensors may be connected using only **five** sensor terminal blocks plus power supply terminal block.

Color	Item No.	Pack. Unit	Color	Item No.	Pack. Unit
4-conductor sensor terminal block, with ground connection			4-conductor sensor LED terminal block, for PNP (high-side) switching sensors, yellow LED, with ground connection		
○ gray	2000-5417	50	○ gray	2000-5417/1102-950	50
○ gray	2000-5410	50 ⑥	○ gray	2000-5410/1102-950	50 ⑥
4-conductor sensor LED terminal block, for NPN (low-side) switching sensors, yellow LED, with ground connection			4-conductor sensor LED terminal block, for NPN (low-side) switching sensors, yellow LED, with ground connection		
○ gray	2000-5417/1101-951	50	○ gray	2000-5417/1101-951	50 ⑥
○ gray	2000-5410/1101-951	50 ⑥	○ gray	2000-5410/1101-951	50 ⑥

Accessories for 4-Conductor Terminal Blocks

Appropriate marking systems:

WMB/Marking Strips/WMB Inline

End and intermediate plate, 1 mm thick,
for 4-conductor terminal blocks
○ 2000-5491 100

Push-in type jumper bar, insulated,
⑤ IN 14 A, light gray
2-way 2000-402 200
3-way 2000-403 200
:
10-way 2000-410 100
● .../000-005 ● .../000-006
● .../000-018

Push-in type jumper bar, insulated,
IN 14 A, light gray
1 to 3 2000-433 200
1 to 4 2000-434 200
:
1 to 10 2000-440 100

Double-deck marker carrier,
pivoting
○ 2000-121 50

Marking strip, plain,
11 mm wide,
50 m roll
○ 2009-110 1

WMB Multi marking system, plain,
10 strips with 10 markers per card,
for 3.5 mm terminal block width
○ 793-3501 5

Operating tool with a partially insulated shaft,
type 1, (2.5 x 0.4) mm blade
210-719 1

Insulated ferrules, extra long,
for TOPJOB® S terminal blocks,
see page 259

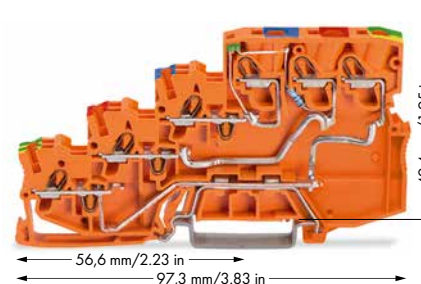
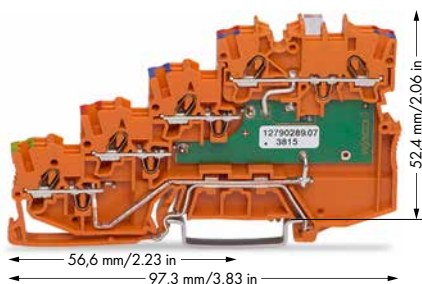

2000-5477

2000-5477/1102-953

2000-5457/1102-953

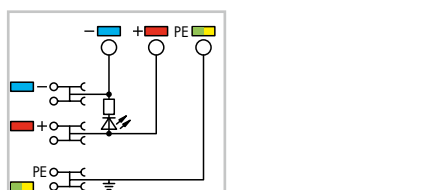
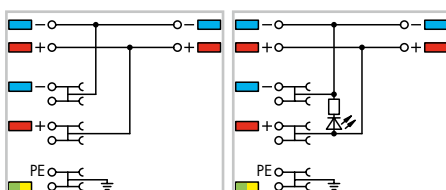

Color	Item No.	Pack. Unit	Color	Item No.	Pack. Unit
4-conductor sensor supply terminal block, max. 250 V, with ground connection			4-conductor sensor supply terminal block, max. 250 V, control panel side: 2.5 (4) mm², max. 28 A, with ground connection		
○ orange	2000-5477	15	○ orange	2000-5457	15
4-conductor sensor LED supply terminal block, 24 VDC green LED, with ground connection			4-conductor sensor LED supply terminal block, 24 VDC, green LED, control panel side: 2.5 (4) mm², max. 28 A, with ground connection		
○ orange	2000-5477/1102-953	15	○ orange	2000-5457/1102-953	15

For technical information and abbreviations, see technical section.

TOPJOB® S

3-Conductor Actuator Terminal Blocks 1 (1.5) mm²

2000 Series

PUSH-IN CAGE CLAMP®

0.14 ... 1 (1.5) mm ² ① 250 V/4 kV/3 ② I _N 13.5 A	24 ... 16 AWG 300 V, 10 A	0.14 ... 1 (1.5) mm ² ① 24 VDC I _N 13.5 A	24 ... 16 AWG 24 VDC, 10 A
Terminal block width: 7 mm / 0.276 in. ③ 9 ... 11 mm / 0.39 in.		Terminal block width: 7 mm / 0.276 in. ③ 9 ... 11 mm / 0.39 in.	
④ Approvals		④ Approvals	

- Conductor range: 0.14 ... 1.5 mm² "s+f-st"
Push-in termination: 0.5 ... 1.5 mm² "s"
and 0.5 ... 0.75 mm²
"insulated ferrules, 10 mm"
- 250 V = Rated voltage
4 kV = Rated impulse voltage
3 = Pollution degree
(see Full Line Catalog)
- 3.5 mm spacing per signal (2 x 3.5 mm = 7 mm)
- For all approvals and corresponding ratings, visit www.wago.com.
- See application notes in our Full Line Catalog.
- Ground connection via commoning to terminal blocks with ground foot

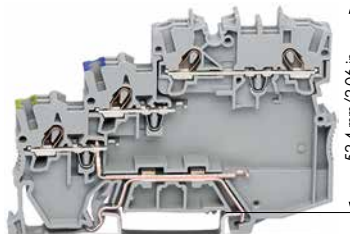

40,4 mm / 1.59 in
81,1 mm / 3.19 in

2000-5317/102-000

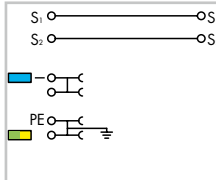



40,4 mm / 1.59 in
81,1 mm / 3.19 in

2000-5310/101-000

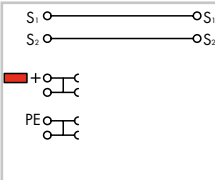



40,4 mm / 1.59 in
81,1 mm / 3.19 in

2000-5317/1102-950

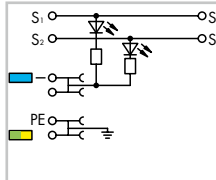



40,4 mm / 1.59 in
81,1 mm / 3.19 in

2000-5310/1101-951

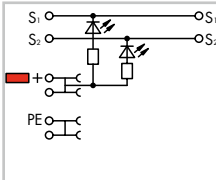











Note:
The double spacing per pole of this terminal block series maximizes connectivity. For example **ten** sensors may be connected using only **five** sensor terminal blocks plus power supply terminal block.

Color	Item No.	Pack. Unit	Color	Item No.	Pack. Unit
3-conductor actuator terminal block, for PNP (high-side) switching actuators, with ground connection			3-conductor actuator LED terminal block, for PNP (high-side) switching actuators, yellow LED, with ground connection		
gray	2000-5317/102-000	50	gray	2000-5317/1102-950	50
gray	2000-5310/102-000	50 ⑥	gray	2000-5310/1102-950	50 ⑥
3-conductor actuator terminal block, for NPN (low-side) switching actuators			3-conductor actuator LED terminal block, for NPN (low-side) switching actuators, yellow LED, with ground connection		
gray	2000-5317/101-000	50	gray	2000-5317/1101-951	50
gray	2000-5310/101-000	50 ⑥	gray	2000-5310/1101-951	50 ⑥

Accessories for 3-Conductor Terminal Blocks

Appropriate marking systems:
WMB/Marking Strips/WMB Inline

End and intermediate plate, 1 mm thick, for 3-conductor terminal blocks	
	2000-5391 100
Push-in type jumper bar, insulated, IN 14 A, light gray	
⑤ 	2-way 2000-402 200
	3-way 2000-403 200
	10-way 2000-410 100
	2000-005
	2000-018
Push-in type jumper bar, insulated, IN 14 A, light gray	
	1 to 3 2000-433 200
	1 to 4 2000-434 200
	1 to 10 2000-440 100
Double-deck marker carrier, pivoting	
	2000-121 50
Marking strip, plain, 11 mm wide, 50 m roll	
	2009-110 1
WMB Multi marking system, plain, 10 strips with 10 markers per card, for 3.5 mm terminal block width	
	793-3501 5
Operating tool with a partially insulated shaft, type 1, (2.5 x 0.4) mm blade	
	210-719 1
Insulated ferrules, extra long, for TOPJOB® S terminal blocks, see page 259	
	

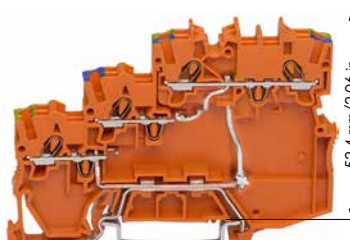

40,4 mm / 1.59 in
81,1 mm / 3.19 in

2000-5377/102-000

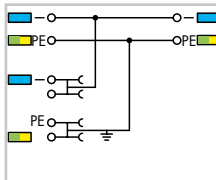



40,4 mm / 1.59 in
81,1 mm / 3.19 in

2000-5377/101-000

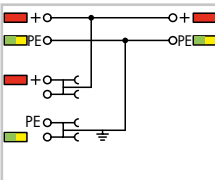



40,4 mm / 1.59 in
81,1 mm / 3.19 in

2000-5357/102-000

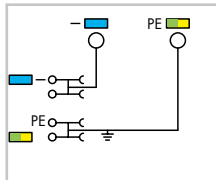



40,4 mm / 1.59 in
81,1 mm / 3.19 in

2000-5357/101-000

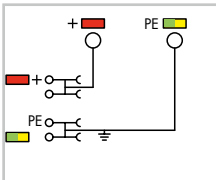

Color	Item No.	Pack. Unit	Color	Item No.	Pack. Unit
3-conductor actuator supply terminal block, max. 250 V, for PNP (high-side) switching actuators, with ground connection			3-conductor actuator supply terminal block, max. 250 V, control panel side: 2.5 (4) mm ² , max. 28 A, for PNP (high-side) switching actuators, with ground connection		
orange	2000-5377/102-000	15	orange	2000-5357/102-000	15
3-conductor actuator supply terminal block, max. 250 V, for NPN (low-side) switching actuators, with ground connection			3-conductor actuator supply terminal block, max. 250 V, control panel side: 2.5 (4) mm ² , max. 28 A, for NPN (low-side) switching actuators, with ground connection		
orange	2000-5377/101-000	15	orange	2000-5357/101-000	15

X-COM®S-SYSTEM-MINI / X-COM®S-SYSTEM – Description and Installation –

PUSH-IN CAGE CLAMP®

Mounting



Snapping terminal block onto carrier rail.

Removal

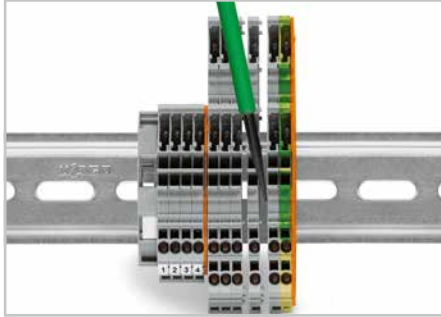

Separate terminal block assembly and slide individual terminal blocks laterally using an operating tool.

Testing

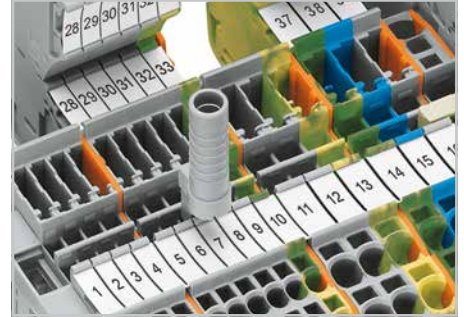

Test plug adapter for 4 mm test plugs or banana plugs – also suitable for X-COM®S-MINI Terminal Blocks.

Locking lever

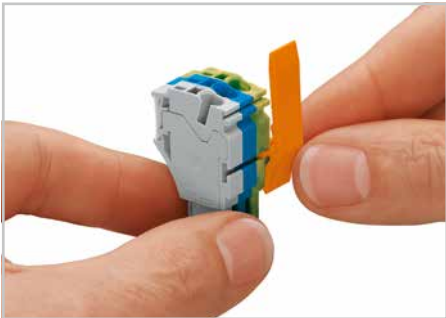

Slide locking lever into position.

Locking lever



Female plugs can be individually locked.

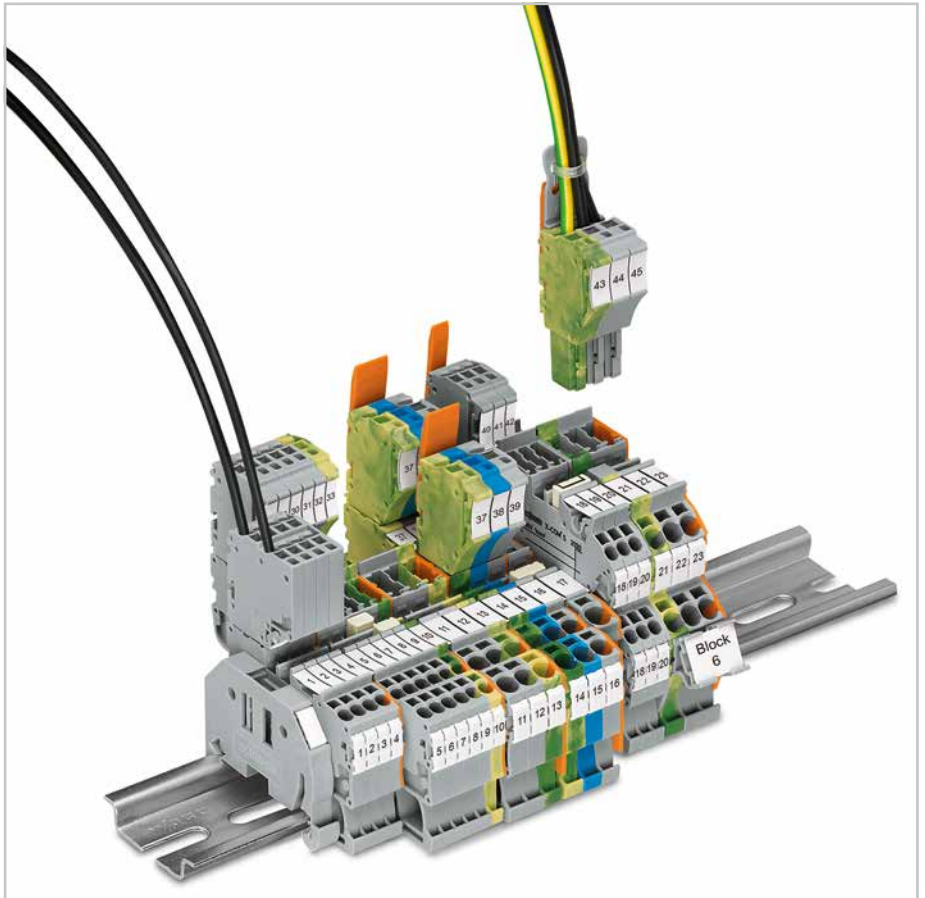

Commoning

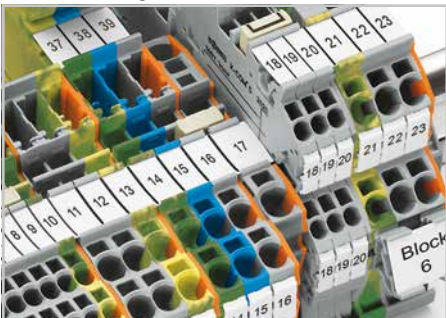

Commoning X-COM® S Terminal Blocks with TOPJOB® S Jumpers. An end plate provides connection to TOPJOB® S Terminal Blocks. 2020 and 2022 Series Terminal Blocks are combinable. Jumper slots are on the same level for both series.

Coding

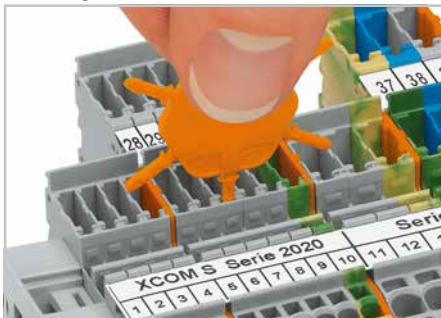



Insert coding pin into the corresponding slot and twist it off.

Coding



Remove coding finger using a cutting tool.







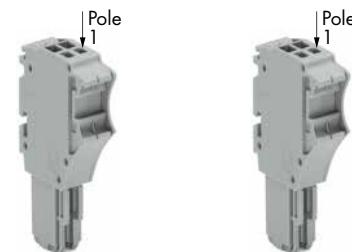
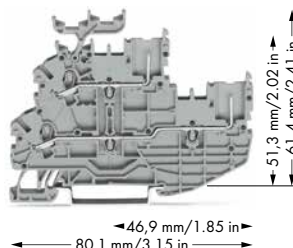
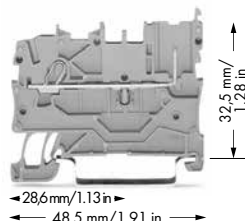

X-COM®S-SYSTEM-MINI**Carrier Terminal Blocks and Female Plugs****2020 Series****PUSH-IN CAGE CLAMP®**

0.14 ... 1 (1.5) mm² ① 24 ... 16 AWG 500 V/6 kV/3 I_N 13.5 A ② Terminal block width: 3.5 mm / 0.138 in.  9 ... 11 mm / 0.39 in. ③ Approvals	0.14 ... 1 (1.5) mm² ① 24 ... 16 AWG 500 V/6 kV/3 I_N 13.5 A ② Terminal block width: 3.5 mm / 0.138 in.  9 ... 11 mm / 0.39 in. ③ Approvals	0.14 ... 1 (1.5) mm² ① 24 ... 16 AWG 500 V/6 kV/3 I_N 13.5 A ② Module width: 3.5 mm / 0.138 in.  9 ... 11 mm / 0.39 in. ③ Approvals
--	--	--

- ① Conductor range: 0.14 ... 1.5 mm² "s+f-st"
 Push-in termination: 0.5 ... 1.5 mm² "s" and 0.5 ... 0.75 mm² "insulated ferrule, 10 mm"



Color	Item No.	Pack. Unit	Color	Item No.	Pack. Unit	Color/Pole No.	Item No.	Pack. Unit
1-conductor/1-pin carrier terminal block, for DIN-35 rail, per EN 60715			1-conductor/1-pin double-deck carrier terminal block, through/through terminal block, for DIN-35 rail, per EN 60715			1-conductor female plug, to be inserted into carrier terminal blocks, with coding fingers, gray		
● gray	2020-1201	50	● L/L	2020-2231	50	● 2-pole	2020-102	100
● blue	2020-1204	50	● N/L	2020-2232	50	● 3-pole	2020-103	50
1-conductor/1-pin ground carrier terminal block			● L/N	2020-2233	50	● 4-pole	2020-104	50
● green-yellow	2020-1207	50	● N/N	2020-2234	50	● 5-pole	2020-105	50
2-conductor/1-pin carrier terminal block,			without marker carrier			● 6-pole	2020-106	50
● gray	2020-1301	50	● L/L	2020-2201	50	● 7-pole	2020-107	25
● blue	2020-1304	50	● N/L	2020-2202	50	● 8-pole	2020-108	25
2-conductor/1-pin ground carrier terminal block			● L/N	2020-2203	50	● 9-pole	2020-109	25
● green-yellow	2020-1307	50	● N/N	2020-2204	50	● 10-pole	2020-110	25
2-conductor/2-pin carrier terminal block			Ground conductor/through terminal block			● 11-pole	2020-111	20
● gray	2020-1401	50	● PE/N	2020-2247	50	● 12-pole	2020-112	20
● blue	2020-1404	50	● PE/L	2020-2257	50	● 13-pole	2020-113	10
2-conductor/2-pin ground carrier terminal block			without marker carrier			● 14-pole	2020-114	10
● green-yellow	2020-1407	50	● PE/N	2020-2217	50	● 15-pole	2020-115	10
Notice: An appropriate end plate must be applied to the carrier terminal blocks after each female plug.			2-conductor/2-pin double-deck carrier terminal block, through/through terminal block, for DIN-35 rail, per EN 60715			2-conductor female plug, to be inserted into carrier terminal blocks, with coding fingers, gray		
			● L	2020-2238	50	● 2-pole	2020-202	100
			● N	2020-2239	50	● 3-pole	2020-203	50
			without marker carrier			● 4-pole	2020-204	50
			● L	2020-2208	50	● 5-pole	2020-205	50
			● N	2020-2209	50	● 6-pole	2020-206	50
			2-conductor/2-pin ground terminal block			● 7-pole	2020-207	25
			● PE	2020-2237	50	● 8-pole	2020-208	25
			without marker carrier			● 9-pole	2020-209	25
			● PE	2020-2207	50	● 10-pole	2020-210	25
						● 11-pole	2020-211	20
						● 12-pole	2020-212	20
						● 13-pole	2020-213	10
						● 14-pole	2020-214	10
						● 15-pole	2020-215	10

Item-Specific Accessories	Item-Specific Accessories	Accessories, Female Plugs										
End and intermediate plate, 1 mm thick, for 1-conductor/1-pin carrier terminal block  <ul style="list-style-type: none"> ● 2020-1292 100 (4x25) ● 2020-1291 100 (4x25) 	End and intermediate plate, 1 mm thick, for 1-conductor/1-pin carrier terminal block  <ul style="list-style-type: none"> ● 2020-2292 100 (4x25) ● 2020-2291 100 (4x25) 	Locking lever, 4.8 mm wide  <ul style="list-style-type: none"> ● 2022-142 100 (4x25) ● 2022-141 100 (4x25) 										
End and intermediate plate, 1 mm thick, for 2-conductor/1-pin carrier terminal block  <ul style="list-style-type: none"> ● 2020-1392 100 (4x25) ● 2020-1391 100 (4x25) 		Locking lever, 9.6 mm wide  <ul style="list-style-type: none"> ● 2022-152 100 (4x25) ● 2022-151 100 (4x25) 										
End and intermediate plate, 1 mm thick, for 2-conductor/2-pin carrier terminal block  <ul style="list-style-type: none"> ● 2020-1492 100 (4x25) ● 2020-1491 100 (4x25) 	Accessories, 2020 Series (see 2020 Series, page 25) Carrier with 6 coding pins, for coding female plugs  <ul style="list-style-type: none"> ● 2020-100 100 (4x25) 	Strain relief plate, gray  <table border="1"> <tr> <td>Width</td> <td></td> </tr> <tr> <td>6 mm</td> <td>734-327 100 (4x25)</td> </tr> <tr> <td>12.5 mm</td> <td>734-328 100 (4x25)</td> </tr> <tr> <td>25 mm</td> <td>734-329 100 (4x25)</td> </tr> <tr> <td>35 mm</td> <td>734-326 100 (4x25)</td> </tr> </table>	Width		6 mm	734-327 100 (4x25)	12.5 mm	734-328 100 (4x25)	25 mm	734-329 100 (4x25)	35 mm	734-326 100 (4x25)
Width												
6 mm	734-327 100 (4x25)											
12.5 mm	734-328 100 (4x25)											
25 mm	734-329 100 (4x25)											
35 mm	734-326 100 (4x25)											

- ② Current-carrying capacity curves upon request ③ For all approvals and corresponding ratings, visit www.wago.com.

X-COM®S-SYSTEM







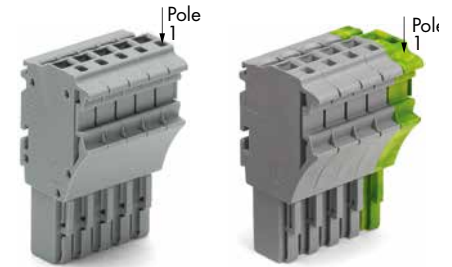
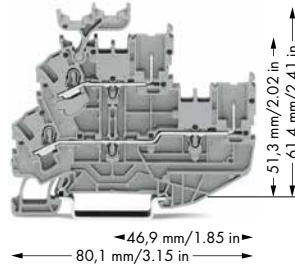
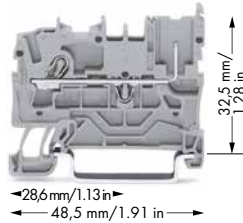

Carrier Terminal Blocks and Female Plugs

2022 Series

<p>0.25 ... 2.5 (4) mm² ① 22 ... 12 AWG 690 V/6 kV/3 I_N 24 A (32 A) ②</p> <p>Terminal block width: 5.2 mm / 0.205 in. 10 ... 12 mm / 0.43 in.</p> <p>③ Approvals</p>	<p>0.25 ... 2.5 (4) mm² ① 22 ... 12 AWG 690 V/6 kV/3 I_N 24 A (32 A) ②</p> <p>Terminal block width: 5.2 mm / 0.205 in. 10 ... 12 mm / 0.43 in.</p> <p>③ Approvals</p>	<p>0.25 ... 2.5 (4) mm² ① 22 ... 12 AWG 690 V/6 kV/3 I_N 24 A (32 A) ②</p> <p>Module width: 5.2 mm / 0.205 in. 10 ... 12 mm / 0.43 in.</p> <p>③ Approvals</p>
--	--	--

- ① Conductor range: 0.25 ... 4 mm² "s+f-st"
Push-in termination: 0.75 ... 4 mm² "s" and 0.75 ... 2.5 mm² "insulated ferrule, 12 mm"



Color	Item No.	Pack. Unit	Color	Item No.	Pack. Unit	Color/Pole No.	Item No.	Pack. Unit
1-conductor/1-pin carrier terminal block, for DIN-35 rail, per EN 60715			1-conductor/1-pin double-deck carrier terminal block, through/through terminal block, for DIN-35 rail, per EN 60715			1-conductor female plug, to be inserted into carrier terminal blocks, with coding fingers, gray		
gray	2022-1201	100	L/L	2022-2231	50	1-pole	2022-101	200
blue	2022-1204	100	N/L	2022-2232	50	2-pole	2022-102	200
orange	2022-1202	100	L/N	2022-2233	50	3-pole	2022-103	100
1-conductor/1-pin ground carrier terminal block			without marker carrier			15-pole 2022-115 25		
green-yellow	2022-1207	100	L/L	2022-2201	50	1-conductor female plug with ground base module, to be inserted into carrier terminal blocks, with coding fingers, gray/green-yellow		
2-conductor/1-pin carrier terminal block			L/N 2022-2202 50			3-pole 2022-103/000-036 100		
gray	2022-1301	100	L/N	2022-2203	50	4-pole 2022-104/000-036 100		
blue	2022-1304	100	N/N	2022-2204	50	5-pole 2022-105/000-036 50		
orange	2022-1302	100	Ground conductor/through terminal block			15-pole 2022-115/000-036 25		
2-conductor/1-pin ground carrier terminal block			PE/N 2022-2247 50			1-conductor female plug with ground end module, to be inserted into carrier terminal blocks, with coding fingers, gray/green-yellow		
green-yellow	2022-1307	100	without marker carrier			3-pole 2022-103/000-037 100		
2-conductor/2-pin carrier terminal block			PE/L 2022-2257 50			4-pole 2022-104/000-037 100		
gray	2022-1401	50	PE/N 2022-2217 50			5-pole 2022-105/000-037 50		
blue	2022-1404	50	PE/L 2022-2227 50			15-pole 2022-115/000-037 25		
orange	2022-1402	50	2-conductor/2-pin double-deck carrier terminal block, through/through terminal block, for DIN-35 rail, per EN 60715					
2-conductor/2-pin ground carrier terminal block			L 2022-2238 50					
green-yellow	2022-1407	50	N 2022-2239 50					
			without marker carrier					
			L 2022-2208 50					
			N 2022-2209 50					
			2-conductor/2-pin ground terminal block					
			PE 2022-2237 50					
			without marker carrier					
			PE 2022-2207 50					
Item-Specific Accessories			Item-Specific Accessories			Accessories, Female Plugs		
End and intermediate plate, 1 mm thick, for 1-conductor/1-pin carrier terminal block			End and intermediate plate, 1 mm thick, for 1-conductor/1-pin carrier terminal block			Locking lever, 4.8 mm wide		
								
orange	2022-1292	100 (4x25)	orange	2022-2292	100 (4x25)	orange	2022-142	100 (4x25)
gray	2022-1291	100 (4x25)	gray	2022-2291	100 (4x25)	gray	2022-141	100 (4x25)
End and intermediate plate, 1 mm thick, for 2-conductor/1-pin carrier terminal block						Locking lever, 9.6 mm wide		
								
orange	2022-1392	100 (4x25)				orange	2022-152	100 (4x25)
gray	2022-1391	100 (4x25)				gray	2022-151	100 (4x25)
End and intermediate plate, 1 mm thick, for 2-conductor/2-pin carrier terminal block						Strain relief plate, gray		
								
orange	2022-1492	100 (4x25)				Width		
gray	2022-1491	100 (4x25)				6 mm 734-327 100 (4x25)		
Accessories, 2022 Series (see 2022 Series, page 27)						12.5 mm 734-328 100 (4x25)		
Carrier with 6 coding pins, for coding female plugs						25 mm 734-329 100 (4x25)		
						35 mm 734-326 100 (4x25)		
orange	2022-100	100 (4x25)				55 mm 734-430 100 (4x25)		
						75 mm 734-431 100 (4x25)		

② Current-carrying capacity curves upon request ③ For all approvals and corresponding ratings, visit www.wago.com.

Classic Rail-Mounted Terminal Blocks - Description and Handling -

Conductor termination/removal



Inserting conductor via screwdriver.

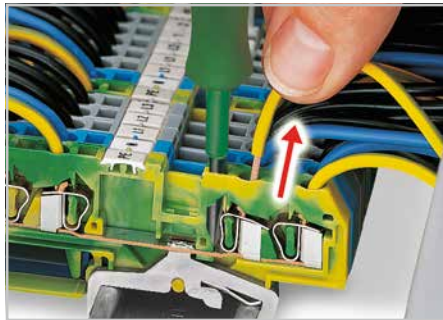

Removing conductor via screwdriver.

Commoning

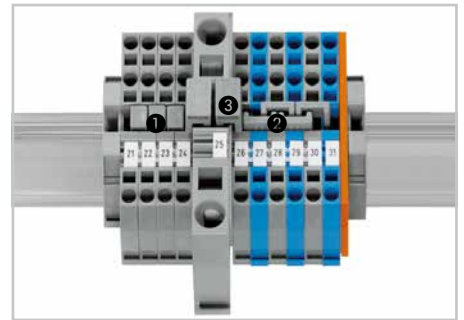

Commoning with adjacent jumpers **1** or staggered jumpers **2**.
Commoning terminal blocks of different sizes - with step down jumpers **3**.

Testing

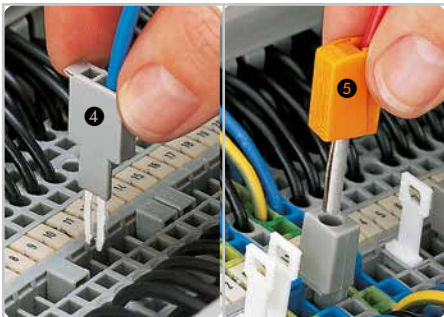

4 CAGE CLAMP®-equipped test plug
5 Test plug (4 mm Ø) via test plug adapter (209-170)

Protective warning marker/ Insulation stop



6 Protective warning marker accommodated in operating tool slots
7 Inserting insulation stop.

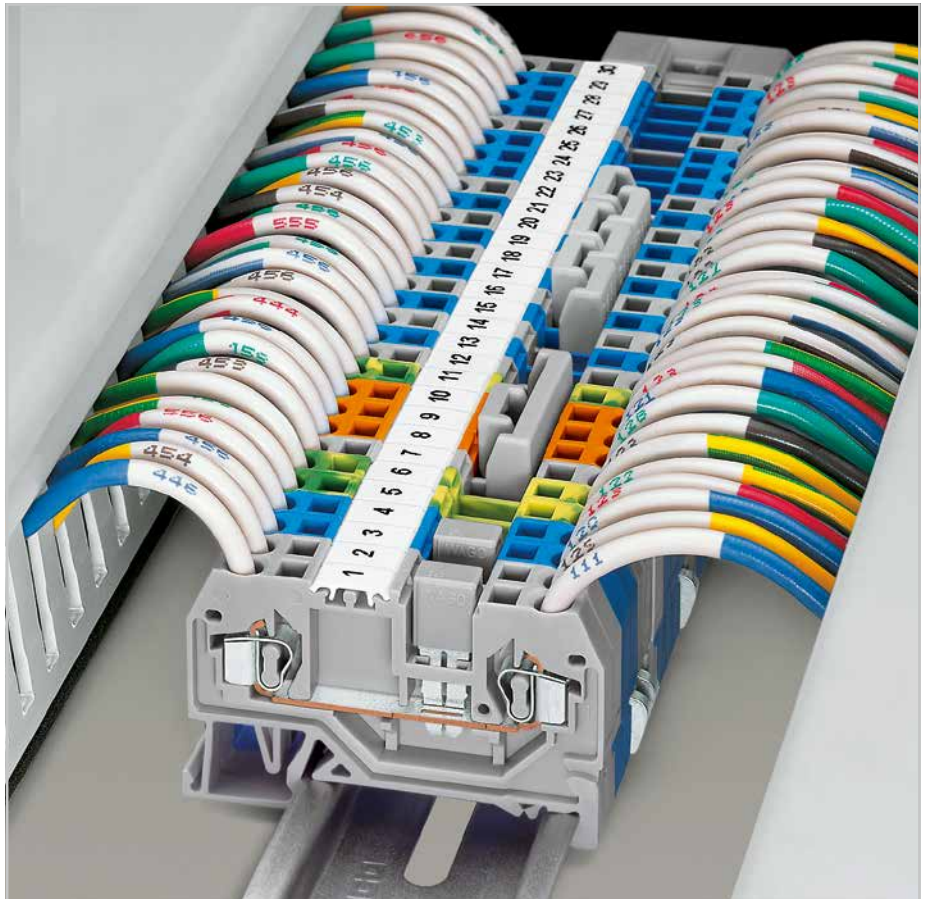

Finger guard



8 Touch-proof cover protects unused conductor entries.
9 Marking via WMB Multi markers.

Marking



Marking WMB markers via IP200 Plotter or smartPRINTER.

Compact rail-mounted terminal blocks 870 Series, see Full Line Catalog







CAGE CLAMP®-equipped rail-mounted terminal blocks

For information on Push-in CAGE CLAMP® connection, see page 14.

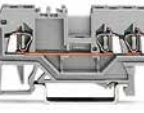
Classic Rail-Mounted Terminal Blocks 1.5 / 2.5 / 4 mm²

279 ... 281 Series



		279 Series 800 V, I _N 18 A 0.08 ... 1.5 mm ² / 28 ... 16 AWG			280 Series 800 V, I _N 24 A 0.08 ... 2.5 mm ² / 28 ... 12 AWG			281 Series 800 V, I _N 32 A 0.08 ... 4 mm ² / 28 ... 12 AWG			
	Description	Color	Item No.	Pack. Unit	Color	Item No.	Pack. Unit	Color	Item No.	Pack. Unit	
	Through terminal block	Grey	279-901	100	Grey	280-901	100	Grey	281-901	100	
	Through terminal block (Ex i)	Blue	279-904	100	Blue	280-904	100	Blue	281-904	100	
	Through terminal block	Orange	279-902	100	Orange	280-902	100	Orange	281-902	100	
	Through terminal block	Red	279-903	100	Red	280-903	100	Red	281-903	100	
	Through terminal block	Black	279-905	100	Black	280-905	100	Black	281-905	100	
	Through terminal block	Yellow	279-906	100	Yellow	280-906	100	Yellow	281-906	100	
	Through terminal block (Ex e II)	White	279-992 ☒	100	White	280-992 ☒	100	White	281-992 ☒	100	
	Carrier terminal block		-		Grey	280-916	100	Grey	281-916	50	
	Ground conductor terminal block		Green/Yellow	279-907	100	Green/Yellow	280-907	100	Green/Yellow	281-907	100
	End and intermediate plate		Orange	279-328	100	Orange	280-309	100	Orange	281-329	100
	Through terminal block	Grey	279-681	100	Grey	280-681	100	Grey	281-681	100	
	Through terminal block (Ex i)	Blue	279-684	100	Blue	280-684	100	Blue	281-684	100	
	Through terminal block	Orange	279-682	100	Orange	280-650	100	Orange	281-678	100	
	Through terminal block	Red	279-683	100	Red	280-653	100	Red	281-679	100	
	Through terminal block	Black	279-685	100	Black	280-671	100	Black	281-685	100	
	Through terminal block	Yellow	279-686	100	Yellow	280-672	100	Yellow	281-686	100	
	Through terminal block (Ex e II)	White	279-993 ☒	100	White	280-993 ☒	100	White	281-993 ☒	100	
	Carrier terminal block		-		Grey	280-610	100	Grey	281-610	50	
	Ground conductor terminal block		Green/Yellow	279-687	100	Green/Yellow	280-687	100	Green/Yellow	281-687	100
	End and intermediate plate		Orange	279-339	100	Orange	280-326	100	Orange	281-326	100
	Through terminal block	Grey	279-831	50	Grey	280-833	50	Grey	281-652	50	
	Through terminal block (Ex i)	Blue	279-834	50	Blue	280-834	50	Blue	281-654	50	
	Through terminal block	Orange	279-832	50	Orange	280-835	50	Orange	281-653	50	
	Through terminal block	Red	279-833	50	Red	280-830	50	Red	281-663	50	
	Through terminal block	Black	279-835	50	Black	280-831	50	Black	281-664	50	
	Through terminal block	Yellow	279-836	50	Yellow	280-832	50	Yellow	281-668	50	
	Through terminal block (Ex e II)	White	279-994 ☒	50	White	280-994 ☒	50	White	281-994 ☒	50	
	Carrier terminal block		-		Grey	280-816	100	Grey	281-816	50	
	Ground conductor terminal block		Green/Yellow	279-837	50	Green/Yellow	280-837	50	Green/Yellow	281-657	50
	End and intermediate plate		Orange	279-346	100	Orange	280-315	100	Orange	281-335	100
		Grey	279-344	100	Grey	280-314	100	Grey	281-334	100	

		280 Series, 800 V, I _N 24 A 0.08 ... 2.5 mm ² / 28 ... 12 AWG			281 Series, 800 V, I _N 32 A 0.08 ... 4 mm ² / 28 ... 12 AWG			
Technical Data	Description	Color	Item No.	Pack. Unit	Color	Item No.	Pack. Unit	
	Through terminal block	Grey	280-641	100	Grey	281-631	100	
	Through terminal block (Ex i)	Blue	280-651	100	Blue	281-651	100	
	Through terminal block	Orange	280-654	100	-	-	-	
	Through terminal block (Ex e II)	White	280-998 ☒	100	White	281-998 ☒	100	
	Ground conductor terminal block		Green/Yellow	280-637	100	Green/Yellow	281-637	100
3-Conductor	End and intermediate plate, 2.5 mm thick		Orange	280-313	100	Orange	281-313	100
			Grey	280-312	100	Grey	281-312	100
	Through terminal block	Grey	280-646	100	-	-	-	
	Through terminal block (Ex i)	Blue	280-656	100	-	-	-	
	Through terminal block	Orange	280-946	100	-	-	-	
	Through terminal block (Ex e II)	White	280-996 ☒	100	-	-	-	
	Ground conductor terminal block		-	-	-	-	-	
4-Conductor	End and intermediate plate, 2.5 mm thick		Orange	280-313	100	-	-	
			Grey	280-312	100	-	-	



For suitable adjacent jumpers, see page 72.

Notice: 280-646 blocks and their colored variants cannot be commoned.

Classic Rail-Mounted Terminal Blocks 6 / 10 / 16 / 35 mm² 282 ... 285 Series

		282 Series, 800 V, I _N 41 A 0.2 ... 6 mm ² / 24 ... 10 AWG			284 Series, 800 V, I _N 57 A 0.2 ... 10 mm ² / 24 ... 8 AWG			283 Series, 800 V, I _N 76 A 0.2 ... 16 mm ² / 24 ... 6 AWG		
Technical Data	Description	Color	Item No.	Pack. Unit	Color	Item No.	Pack. Unit	Color	Item No.	Pack. Unit
 2-Conductor	Through terminal block	Gray	282-901	50	Gray	284-901	25	Gray	283-901	20
	Through terminal block (Ex i)	Blue	282-904	50	Blue	284-904	25	Blue	283-904	20
	Through terminal block	Orange	282-902	50	Orange	284-902	25	Orange	283-902	20
	Through terminal block (Ex e II)	White	282-992	50	White	284-992	25	White	283-992	20
	Ground conductor terminal block	Green/Yellow	282-907	50	Green/Yellow	284-907	25	Green/Yellow	283-907	20
	End and intermediate plate	Orange	282-328	100	Orange	284-328	100	Orange	283-328	50
 3-Conductor	Through terminal block	Gray	282-681	25	Gray	284-681	25	Gray	283-671	20
	Through terminal block (Ex i)	Blue	282-684	25	Blue	284-684	25	Blue	283-674	20
	Through terminal block	Orange	282-682	25	Orange	284-682	25	Orange	283-672	20
	Through terminal block (Ex e II)	White	282-993	25	White	284-993	25	White	283-998	20
	Ground conductor terminal block	Green/Yellow	282-687	25	Green/Yellow	284-687	25	Green/Yellow	283-677	20
	End and intermediate plate	Orange	282-339	100	Orange	284-339	100	Orange	283-352	50
		Gray	282-308	100	Gray	284-308	100	Gray	283-350	50

<p>285 Series with integrated end plate 1000 V, I_N 125 A 6 ... 35 mm² / 8 ... 2 AWG</p>
--

Technical Data	Description	Color	Item No.	Pack. Unit
 2-Conductor	Through terminal block	Gray	285-635	15
	Through terminal block (Ex i)	Blue	285-634	15
	Through terminal block (Ex e II)	White	285-992 	15
	Ground conductor terminal block	Green/Yellow	285-637	15

<p>284 Series 800 V, I_N 125 A 3 x CAGE CLAMP® 0.2 ... 10 mm² / 24 ... 8 AWG 1 x screw clamp 6 ... 35 mm / 10 ... 2 AWG</p>

Technical Data	Description	Color	Item No.	Pack. Unit
 	Distribution terminal block	Gray	284-621	15
	Distribution terminal block	Blue	284-624	15
	Comb-style jumper bar	Gray	284-412	100

Adjacent Jumpers for 279 ... 284 Series

	Compatible with	Nominal Current	Color	Item No.	Pack. Unit
	279 Series	I _N 15 A	Gray	279-402	200
			Yellow	279-422	200
	280 Series	I _N = I _N terminal block	Gray	280-402	200
			Yellow	280-422	200
	281 Series	I _N = I _N terminal block	Gray	281-402	200
			Yellow	281-422	200
	282 Series	I _N 41 A	Gray	282-402	100
			Yellow	282-422	100
	284 Series	I _N 57 A	Gray	284-402	100
			Yellow	284-422	100
	283 Series	I _N 70 A	Gray	283-402	50
			Yellow	283-422	50

Staggered Jumpers for 280 and 281 Series

	Description	Color	Item No.	Pack. Unit
	for 280 Series 5 mm wide I _N 24 A		1 to 2	Gray 780-452 100
			1 to 3	Gray 780-453 100
			1 to 4	Gray 780-454 100
			1 to 5	Gray 780-455 50
			1 to 6	Gray 780-456 50
			1 to 7	Gray 780-457 50
			1 to 8	Gray 780-458 50
		for 281 Series 6 mm wide I _N 32 A		1 to 2
			1 to 3	Gray 781-453 100
			1 to 4	Gray 781-454 100
			1 to 5	Gray 781-455 50
		1 to 6	Gray 781-456 50	





Vertical Jumper for Double- and Triple-Deck Terminal Blocks

	Description	Item No.	Pack. Unit
	insulated, I _N 24 A, gray	Gray 281-421	200

Classic Double-/Triple-Deck and Electric Motor Wiring Rail-Mounted Terminal Blocks

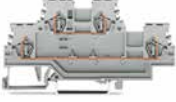
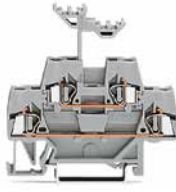
279 ... 281 Series







CAGE CLAMP®

	Technical Data	Description	Color	Item No.	Pack. Unit
	279 Series 0.08 ... 1.5 mm ² / 28 ... 16 AWG I _N 18 A, 500 V	Through/through terminal block, L/L	○	279-501	50
		Through/through terminal block, N/L	○	279-512	50
		Through/through terminal block, L/N	○	279-513	50
		Through/through terminal block, N/N (Ex i)	●	279-504	50
		Ground conductor/through terminal block, PE/N	○	279-517	50
		Ground conductor/through terminal block, PE/L	○	279-527	50
		3-conductor through terminal block, L	○	279-508	50
		4-conductor through terminal block, N (Ex i)	●	279-509	50
		4-conductor ground terminal block, PE	●	279-507	50
		End and intermediate plate	○	279-519	100
			○	279-518	100
	280 Series 0.08 ... 2.5 mm ² / 28 ... 12 AWG I _N 20 A, 500 V	Through/through terminal block	○	280-519	50
		Through/through terminal block (Ex i)	●	280-529	50
		Through/through terminal block (blue/gray)	■	280-523	50
		Through/through terminal block (gray/blue)	■	280-533	50
		Ground conductor/through terminal block (green-yellow/gray)	■	280-527	50
		Ground conductor/through terminal block (green-yellow/blue)	■	280-537	50
		4-conductor ground terminal block, internally commoned	●	280-517	50
	280 Series 0.08 ... 2.5 mm ² / 28 ... 12 AWG I _N 20 A, 500 V	Through/through terminal block*	○	280-520	50
		Through/through terminal block*	●	280-530	50
		Through/through terminal block*	■	280-524	50
		Through/through terminal block*	■	280-534	50
		End and intermediate plate	○	280-341	50
			○	280-340	50
		End and intermediate plate (for additional horizontal commoning)	○	280-343	50
	○	280-342	50		
	280 Series 0.08 ... 2.5 mm ² / 28 ... 12 AWG I _N 20 A, 500 V	Through/through/through terminal block	○	280-549	40
		Through/through/through terminal block (Ex i)	●	280-551	40
		Through/through/through terminal block	■	280-552	40
		Ground conductor/through/through terminal block	■	280-557	40
		Ground conductor/through/through terminal block	■	280-547	40
		Shield conductor/through/through terminal block	■	280-548	40
		Shield conductor/through/through terminal block	■	280-558	40
		6-conductor ground terminal block, internally commoned	●	280-597	40
		Ground conductor/through/carrier terminal block	■	280-510	50
		Through/through/through terminal block with additional jumper position on lower level	○	280-550	40
		End and intermediate plate	○	280-304	50
			○	280-303	50
		End and intermediate plate (for additional horizontal commoning)	○	280-306	50
	○	280-305	50		
	281 Series 0.08 ... 4 mm ² / 28 ... 12 AWG I _N 26 A, 500 V	Through/through terminal block	○	281-619	50
		Through/through terminal block (Ex i)	●	281-629	50
		Through/through terminal block*	○	281-620	50
		Through/through terminal block*	●	281-630	50
		End and intermediate plate	○	281-341	100
			○	281-340	100
		End and intermediate plate (for additional horizontal commoning)	○	281-343	100
			○	281-342	100
	281 Series 0.08 ... 4 mm ² / 28 ... 12 AWG I _N 20 A (2.5 mm ²), 400 V I _N 25 A (4 mm ²), 400 V	Quadruple-deck terminal block, L1 - L2 - L3 - PE	○	281-530	50
		Quadruple-deck terminal block, L1 - L2	○	281-531	50
		Quadruple-deck terminal block, L1 - L2 - L3	○	281-532	50
		End and intermediate plate	○	281-366	100
			○	281-365	100

For 279, 280 and 281 Series accessories, see www.wago.com and Full Line Catalog.

*with additional jumper position

Classic Side-Entry Rail-Mounted Terminal Blocks 1.5 ... 16 mm² 279 ... 284 Series

	Technical Data	Description	Color	Item No.	Pack. Unit
	279 Series 0.08 ... 1.5 mm ² / 28 ... 16 AWG I _N 18 A, 800 V Terminal block width: 4 mm / 0.157 in. Strip length: 8 ... 9 mm / 0.33 in.	2-conductor through terminal block	Grey	279-101	100
		2-conductor through terminal block (Ex i)	Blue	279-104	100
		End and intermediate plate, 2.5 mm thick	Orange	279-302	100
			Grey	279-301	100
	280 Series 0.08 ... 2.5 mm ² / 28 ... 12 AWG I _N 24 A, 800 V Terminal block width: 5 mm / 0.197 in. Strip length: 8 ... 9 mm / 0.33 in.	2-conductor through terminal block	Grey	280-101	100
		2-conductor through terminal block (Ex i)	Blue	280-104	100
		2-conductor ground terminal block	Yellow-Green	280-107	100
		End and intermediate plate, 2.5 mm thick	Orange	280-302	100
			Grey	280-301	100
	281 Series 0.08 ... 4 mm ² / 28 ... 12 AWG I _N 32 A, 800 V Terminal block width: 6 mm / 0.236 in. Strip length: 9 ... 10 mm / 0.37 in.	2-conductor through terminal block	Grey	281-101	100
		2-conductor through terminal block (Ex i)	Blue	281-104	100
		2-conductor ground terminal block	Yellow-Green	281-107	100
		End and intermediate plate, 3 mm thick	Orange	281-302	100
			Grey	281-301	100
	282 Series 0.2 ... 6 mm ² / 28 ... 12 AWG I _N 41 A, 800 V Terminal block width: 8 mm / 0.315 in. Strip length: 12 ... 13 mm / 0.49 in.	2-conductor through terminal block	Grey	282-101	50
		2-conductor through terminal block (Ex i)	Blue	282-104	50
		2-conductor ground terminal block	Yellow-Green	282-107	50
		End and intermediate plate, 4 mm thick	Orange	282-302	100
			Grey	282-301	100
	284 Series 0.2 ... 10 mm ² / 24 ... 8 AWG I _N 57 A, 800 V Terminal block width: 10 mm / 0.394 in. Strip length: 12 ... 13 mm / 0.49 in.	2-conductor through terminal block	Grey	284-101	50
		2-conductor through terminal block (Ex i)	Blue	284-104	50
		2-conductor ground terminal block	Yellow-Green	284-107	50
		End and intermediate plate, 2.5 mm thick	Orange	284-302	100
			Grey	284-301	100
	283 Series 0.2 ... 16 mm ² / 24 ... 6 AWG I _N 76 A, 800 V Terminal block width: 12 mm / 0.472 in. Strip length: 16 ... 17 mm / 0.65 in.	2-conductor through terminal block	Grey	283-101	50
		2-conductor through terminal block (Ex i)	Blue	283-104	50
		2-conductor ground terminal block	Yellow-Green	283-107	50
		End and intermediate plate, 4 mm thick	Orange	283-302	50
			Grey	283-301	50

For suitable jumpers, see page 72.

Conductor termination

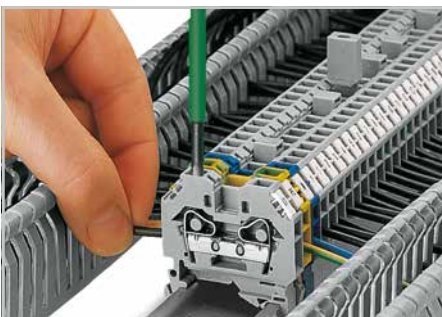

Open the clamping unit using a screwdriver and insert stripped conductor until it hits backstop.

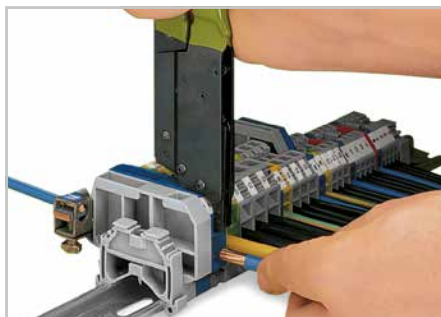

The plunger (210-141) is placed into the upper operating slot of a side-entry terminal block and the clamp is hooked into the lateral operating slot. The contact is fully opened by pressing the handles together until they engage.
Insert stripped conductor until it hits backstop.

Fuse terminal blocks

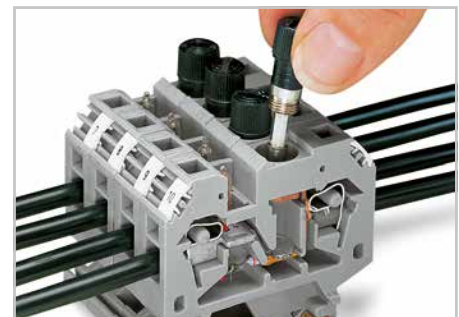

Replacing a fuse.





Classic Side-Entry Function Terminal Blocks

Disconnect/Test Terminal Blocks, Fuse Terminal Blocks, Step-Down Jumpers



282 Series

CAGE CLAMP®

Disconnect/Test Terminal Blocks

	Technical Data	Description	Color	Item No.	Pack. Unit
	282 Series 0.2 ... 6 mm ² / 24 ... 10 AWG I _N 41 A, 400 V Terminal block width: 8 mm / 0.315 in. Strip length: 12 ... 13 mm / 0.49 in.	Disconnect/test terminal block, with 4 mm Ø test sockets	●	282-131	25
		Through terminal block	●	282-133	25
		Disconnect/test terminal block, without test sockets	●	282-135	25
	282 Series 0.2 ... 6 mm ² / 24 ... 10 AWG Terminal block width: 16 mm / 0.63 in. Strip length: 12 ... 13 mm / 0.49 in.	Ground conductor disconnect terminal block, 24 V	●	282-140	12
		Ground conductor disconnect terminal block, 48 V	●	282-141	12
		Ground conductor disconnect terminal block, 120 V	●	282-138	12
		Ground conductor disconnect terminal block, 230 V	●	282-139	12
		End and intermediate plate, 4 mm thick	●	282-315	50
			●	282-314	50
		Lock-out, snap-on type, prevents reclosing of slide link	●	282-137	100

Fuse Terminal Blocks

	Technical Data	Description	Color	Item No.	Pack. Unit
	282 Series 2-conductor fuse terminal blocks 0.2 ... 6 mm ² / 24 ... 10 AWG I _N 10 A, 500 V Terminal block width: 13 mm / 0.512 in. Strip length: 12 ... 13 mm / 0.49 in.	Without indicator, for 5 x 20 mm miniature metric fuses	●	282-122	40
		Without indicator, for 1/4" x 1" miniature metric fuses	●	282-120	40
		Without indicator, for 1/4" x 1 1/4" miniature metric fuses	●	282-128	40
		With indicator, for 5 x 25 mm miniature metric fuses	●	282-126	40
	282 Series 2-conductor fuse terminal blocks 0.2 ... 6 mm ² / 24 ... 10 AWG Terminal block width: 13 mm / 0.512 in. Strip length: 12 ... 13 mm / 0.49 in.	With red LED 24 VDC, for 1/4" x 1 1/4" miniature metric fuses	●	282-128/281-413	40
		With blown fuse indication by neon lamp, 250 VAC/220 VDC, for 1/4" x 1 1/4" miniature metric fuses	●	282-128/281-417	40
		With blown fuse indication by neon lamp, 250 VAC/220 VDC, for 5 x 20 mm miniature metric fuses	●	282-124	40
		With blown fuse indication by neon lamp, 120 V AC/DC, for 1/4" x 1 1/4" miniature metric fuses	●	282-128/281-418	40
		End and intermediate plate, 4 mm thick	●	282-312	50
			●	282-311	50

Step-Down Jumpers

	Technical Data	Description	Color	Item No.	Pack. Unit
	Insulated, I _N 15 A	From 10/6 mm ² to 4/2.5/1.5 mm ²	●	284-414	50
		From 10/6 mm ² to 6/4 mm ²	●	284-413	50
	Insulated, I _N 32 A	From 16 mm ² to 4 mm ²	●	283-414	50

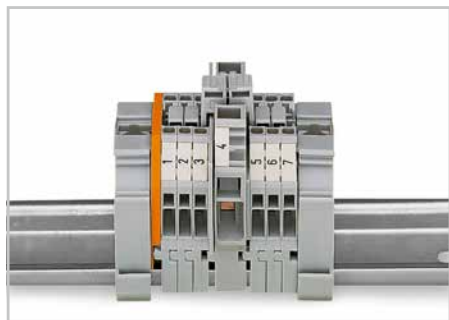

Commoning from 6 mm² (282 Series) to 1.5 mm² (279 Series) rail-mounted terminal blocks via step-down jumpers.

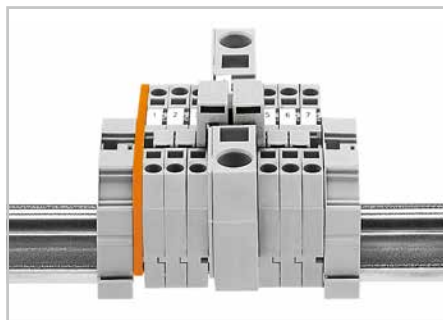

Commoning from 16 mm² (283 Series) to 4 mm² (281 Series) rail-mounted terminal blocks via step-down jumpers.

Classic Sensor and Actuator Terminal Blocks – Description and Installation –

Mounting

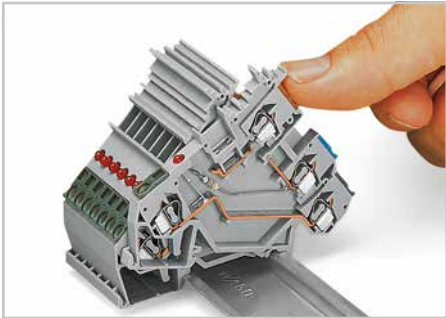

Snapping terminal block onto carrier rail. Terminal blocks with a grounding foot automatically establish a direct contact to the rail.

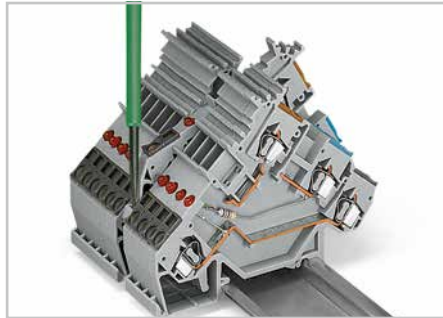

Removing the terminal block from carrier rail. Notice: Remove jumper contacts first.

CAGE CLAMP® connection

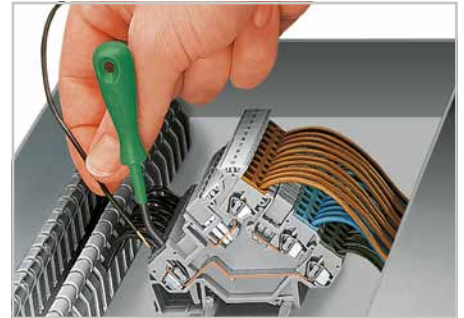

Inserting conductor via angled (3.5 x 0.5) mm screwdriver.

Commoning



Commoning with adjacent jumpers – push jumper down until fully inserted.

Actuator terminal blocks (see Full Line Catalog)



Actuator terminal blocks with fuse holders (281-511) – intermediate plates are also required!

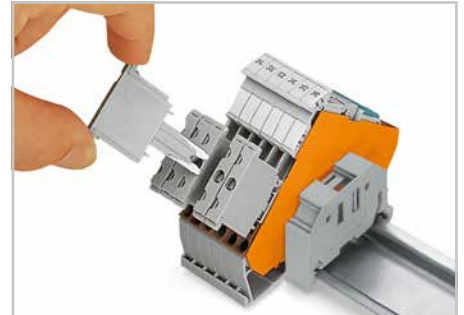

Actuator terminal blocks with component plugs (280-801)

Power supply

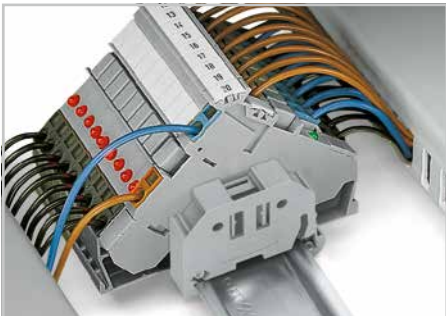

Sensor terminal blocks – power supply from control panel side

Testing

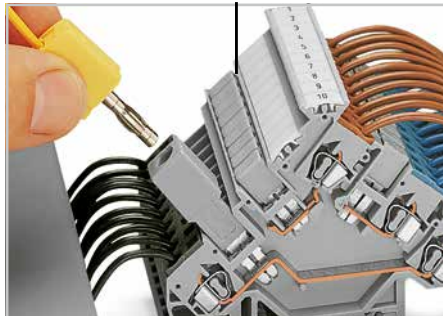

Testing via banana plug and 209-170 test plug adapter.

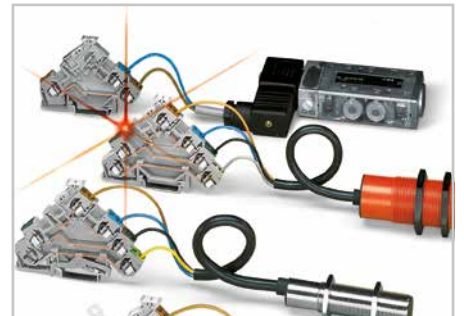

Clear assignment: one sensor – one terminal block

Power supply

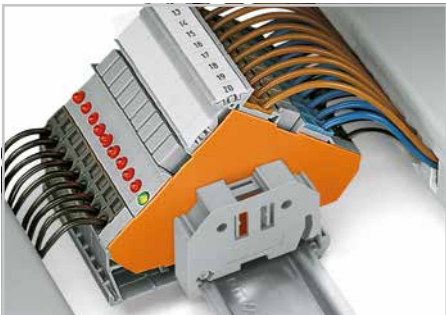

Sensor terminal blocks – power supply from sensor side.

270 Series, see Full Line Catalog

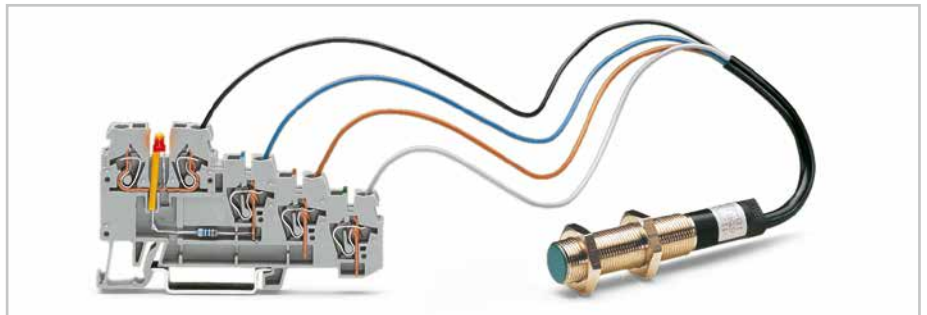

Sensor LED terminal block

For information on Push-in CAGE CLAMP® connection, see page 14.

Classic Sensor and Actuator Terminal Blocks

280 Series

	+ Supply	- Supply	Signal	Ground/Shield	LED	PNP/NPN	Recovery Diode	Supply Terminal Block	End Plate	Color	Item No.	Pack. Unit
										●		
	X	X	1						a	●	280-560	50
	X	X	1		X	p			a	●	280-560/281-434	50
	X	X	1		X	n			a	●	280-560/281-413	50
	X	X						X	a	●	280-564	10
	X	X			X	p		X	a	●	280-564/281-483	10
	X	X			X	n		X	a	●	280-564/281-496	10
	X	X	1	X					b	●	280-570	50
	X	X	1	X	X	p			b	●	280-570/281-434	50
	X	X	1	X	X	n			b	●	280-570/281-413	50
	X	X		X				X	b	●	280-574	10
	X	X		X	X	p		X	b	●	280-574/281-483	10
	X	X		X	X	n		X	b	●	280-574/281-496	10
	X	X	2						b	●	280-580	50
	X	X	2		X	p			b	●	280-580/281-434	50
	X	X	2		X	n			b	●	280-580/281-413	50
	X	X						X	b	●	280-584	10
	X	X			X	p		X	b	●	280-584/281-483	10
	X	X			X	n		X	b	●	280-584/281-496	10
		X	1						a	●	280-562	50
		X	1				X		a	●	280-562/281-411	50
		X			X	p			a	●	280-562/281-434	50
		X	1		X	p	X		a	●	280-562/281-420	50
		X						X	a	●	280-592	10
		X	1	X					b	●	280-572	50
		X	1	X			X		b	●	280-572/281-411	50
		X	1	X	X	p			b	●	280-572/281-434	50
		X	1	X	X	p	X		b	●	280-572/281-420	50
		X						X	b	●	280-593	10
	X		1						a	●	280-555	50
	X							X	a	●	280-556	20
	X		1	X					b	●	280-585	50
	X			X			X	b	●	280-586	50	

Accessories

	Description	Color	Item No.	Pack. Unit
		●		
	End and intermediate plate, 1 mm thick	●	280-321	100
		●	280-319	100
		●	280-323	100
		●	280-320	100
	Adjacent jumper, insulated $I_N = I_N$ terminal block	●	280-402	200
		●	280-470	200
	Insulation stop, 5 pcs/strip 0.08 ... 0.2 mm ² "sol."	●	280-471	200
		●	280-472	200
		●	280-472	200

Classic Fuse Terminal Blocks and Fuse Plugs – Description and Installation –

Fuse terminal blocks



Blown fuse indication by LED or neon lamp

Fuse plug

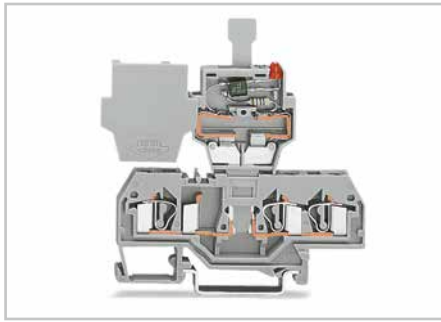

Fuse plug with blown fuse indication on a 3-conductor carrier terminal block.



Conductor termination: Open the clamping unit via integrated lever.

Commoning

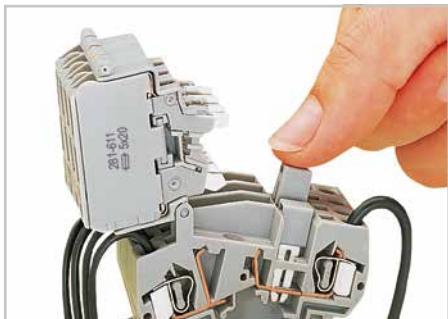

Distributing current to several fuse-protected circuits via insulated touch-proof jumpers.

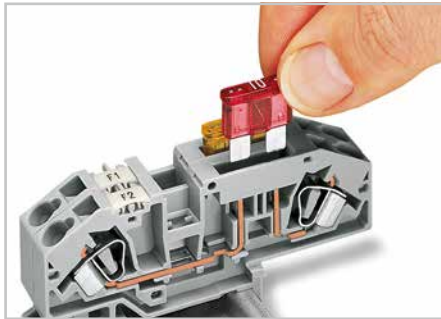

Inserting a fuse.



Open and close lever via screwdriver.

Fuse replacement 1



Before replacing the fuse, pivot the fuse holder into the locked open position.

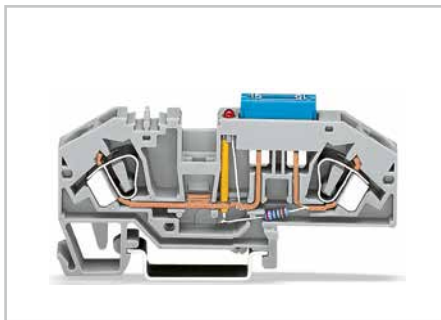

2-conductor fuse terminal block with mini-automotive blade-style fuse



Jumper bar for quick and convenient commoning

Fuse replacement 2



One end of the fuse is automatically ejected from the holder when opening the cover.



Blown fuse indication by LED









Inserting a fuse.

For information on Push-in CAGE CLAMP® connection, see page 14.

Classic Fuse Terminal Blocks and Fuse Plugs

281 / 282 / 811 Series

	Description	Miniature Fuse	Blown Fuse Indication	Nominal Current	Nominal Voltage	Color	Item No.	Pack. Unit
	Fuse disconnect terminal block with pivoting fuse holder; without blown fuse indication 800 V / 10 A (6.3 A) 0.08 ... 4 mm ² / 28 ... 12 AWG	5 x 20 mm				Grey	281-611	50
		5 x 20 mm				Orange	281-616	50
		5 x 25 mm				Grey	281-612	50
		5 x 30 mm				Grey	281-622	50
		1/4" x 1"				Grey	281-613	50
		1/4" x 1 1/4"				Grey	281-623	50
	Fuse disconnect terminal block with pivoting fuse holder; with blown fuse indication by LED 800 V / 10 A (6.3 A) 0.08 ... 4 mm ² / 28 ... 12 AWG	5 x 20 mm	15 ... 30 V			Grey	281-611/281-541	50
		5 x 20 mm	30 ... 65 V			Grey	281-611/281-542	50
		5 x 25 mm	15 ... 30 V			Grey	281-612/281-541	50
		5 x 25 mm	30 ... 65 V			Grey	281-612/281-542	50
		5 x 30 mm	15 ... 30 V			Grey	281-622/281-541	50
		5 x 30 mm	30 ... 65 V			Grey	281-622/281-542	50
		1/4" x 1"	15 ... 30 V			Grey	281-613/281-541	50
		1/4" x 1"	30 ... 65 V			Grey	281-613/281-542	50
	Fuse disconnect terminal block with pivoting fuse holder; with blown fuse indication by neon lamp 800 V / 10 A (6.3 A) 0.08 ... 4 mm ² / 28 ... 12 AWG	5 x 20 mm	230 V			Grey	281-611/281-417	50
		5 x 20 mm	120 V			Grey	281-611/281-418	50
		5 x 25 mm	230 V			Grey	281-612/281-417	50
		5 x 25 mm	120 V			Grey	281-612/281-418	50
		5 x 30 mm	230 V			Grey	281-622/281-417	50
		5 x 30 mm	120 V			Grey	281-622/281-418	50
		1/4" x 1"	230 V			Grey	281-613/281-417	50
		1/4" x 1"	120 V			Grey	281-613/281-418	50
	1/4" x 1 1/4"	230 V			Grey	281-623/281-417	50	
	1/4" x 1 1/4"	120 V			Grey	281-623/281-418	50	
	Adjacent jumper, insulated, I _N = I _N terminal block					Grey	281-402	200
	End and intermediate plate, 2.5 mm thick					Orange	281-309	100
						Grey	281-311	100
	Fuse plugs on carrier terminal blocks (281 Series Carrier Terminal Blocks see page 73)	for 5 x 20 mm and 5 x 25 mm miniature metric fuses	LED, 48 VDC	6.3 A	250 V	Grey	281-511	50
			LED, 24 V AC/DC					
			Neon lamp, 120 V AC/DC					
			Neon lamp, 230 V AC/DC					
	Fuse terminal blocks for mini-automotive, blade-style fuses 0.2 ... 6 mm ² / 24 ... 10 AWG		12 V, LED, circuit I	25 A	400 V	Grey	282-698/281-429	25
			12 V, LED, circuit II					
			24 V, LED, circuit I					
			24 V, LED, circuit II					
			Without blown fuse indication					
	Adjacent jumper, insulated, I _N 41 A					Grey	282-402	100
	3-conductor through terminal block			41 A	800 V	Grey	282-699	25
						Blue	282-694	25
	End and intermediate plate, 2 mm thick					Orange	282-333	100
						Grey	282-334	100
	Fuse terminal block for cylindrical fuses	10 x 38 mm	Without blown fuse indication, 1-pole	32 A	1000 VDC	Grey	811-316	12
			Blown fuse indication, 1-pole					
	Fuse terminal block for cylindrical fuses 2.5 ... 16 mm ² / 16 ... 6 AWG	10 x 38 mm	Without blown fuse indication, 1-pole	32 A	690 VAC 1000 VDC	Grey	811-310	12
			Without blown fuse indication, 2-pole					
			Without blown fuse indication, 3-pole					
			Blown fuse indication, 1-pole					
			Blown fuse indication, 2-pole					
			Blown fuse indication, 3-pole					
	Fuse terminal block for class CC fuses 2.5 ... 16 mm ² / 16 ... 6 AWG	10 x 38 mm	Without blown fuse indication, 1-pole	32 A	690 VAC 1000 VDC	Grey	811-311	12
			Without blown fuse indication, 2-pole					
			Without blown fuse indication, 3-pole					
			Blown fuse indication, 1-pole					
			Blown fuse indication, 2-pole					
			Blown fuse indication, 3-pole					
Push-in type jumper bar, I _N 63 A, 1000 V			2-way			Grey	811-472	50
			3-way					
			4-way					
			6-way					
			8-way					
			12-way					
						Grey	811-482	20

Classic Test/Disconnect Terminal Blocks with Pivoting Knife Disconnect – Description and Installation –

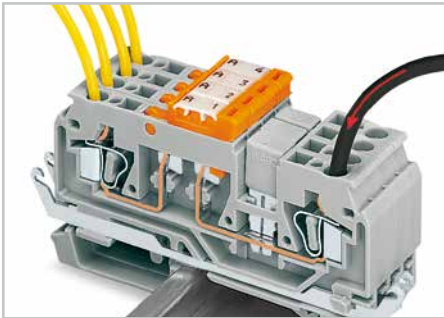

Power distribution using adjacent jumper – knife disconnects used to disconnect individual outputs

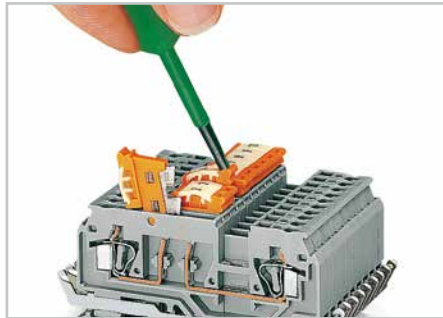

Pivoting knife disconnect

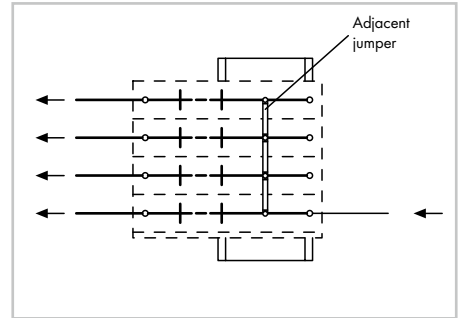

Circuit of assembly shown above

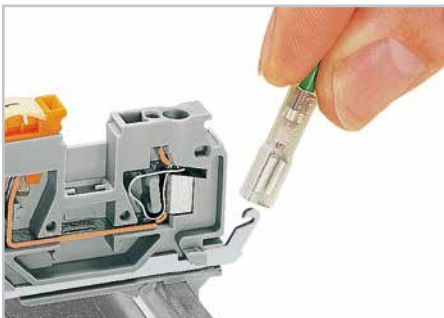

Shield contact via (2.5 x 0.8) mm solder/crimp quick disconnect terminal

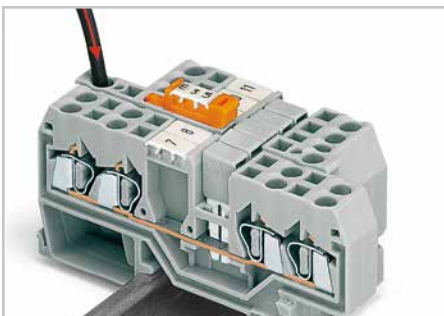
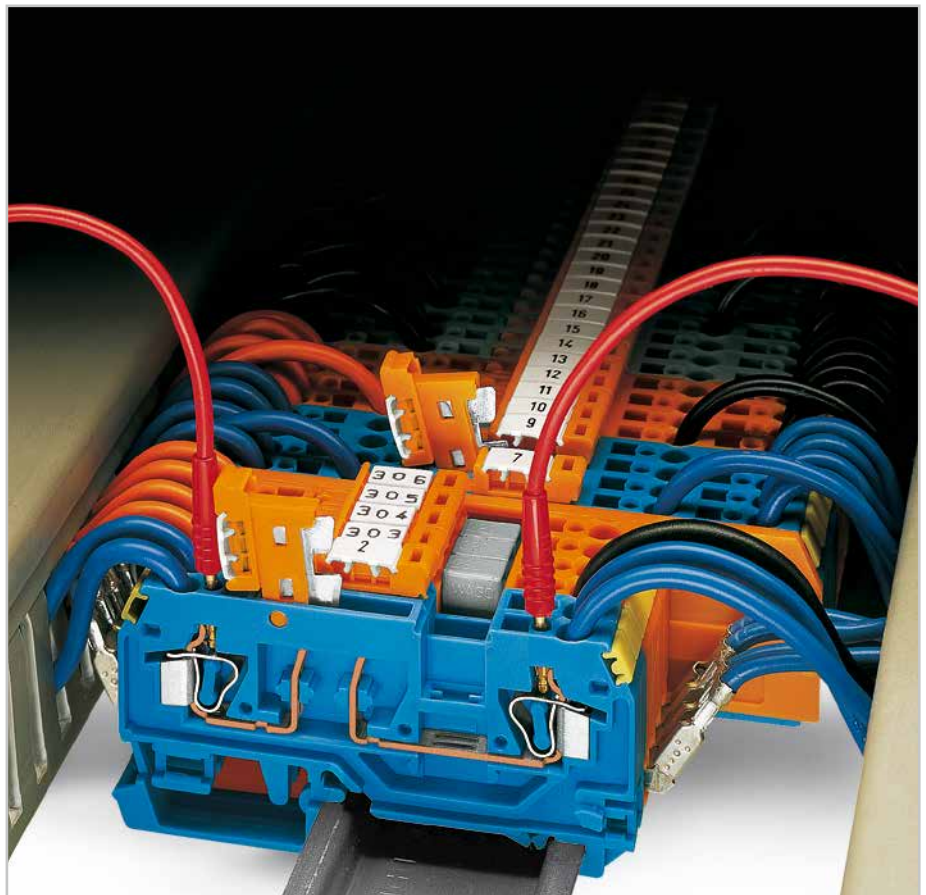

Power distribution using knife disconnect in supply line – disconnection of all outputs

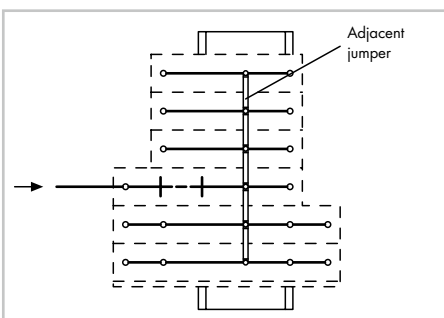

Circuit of assembly shown above

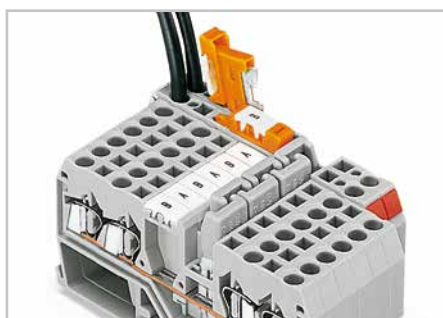



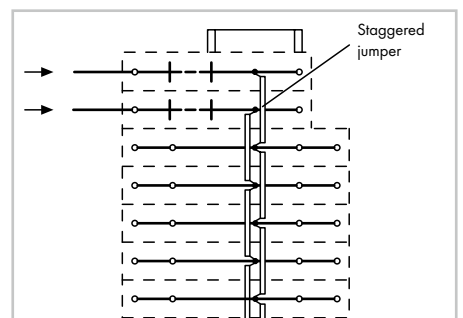



Staggered jumpers for sophisticated circuit requirements – push jumpers down firmly until fully inserted.



Circuit of assembly shown opposite

Classic Disconnect/Test Terminal Blocks

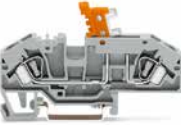
280 / 282 Series

	Description	Technical Data		Terminal Block Width	Color	Item No.	Pack. Unit
	2-conductor disconnect/test terminal block with test slot for 2 mm and 2.3 mm Ø test plugs	0.08 ... 2.5 mm ² / 28 ... 12 AWG	I_N 16 A, 400 V	5 mm / 0.197 in.	●	280-870	100
					●	280-868	100
					●	280-876 [Ⓢ]	100
					●	280-879	100
	2-conductor disconnect/test terminal block with shield contact and test slot for 2 mm and 2.3 mm Ø test plugs	0.08 ... 2.5 mm ² / 28 ... 12 AWG	I_N 16 A, 250 V	5 mm / 0.197 in.	●	280-871	50
					●	280-869	50
					●	280-880	50
	End and intermediate plate, 2.5 mm thick				●	280-371	100
					●	280-374	100
	4-conductor disconnect/test terminal block with test slot for 2 mm and 2.3 mm Ø test plugs	0.08 ... 2.5 mm ² / 28 ... 12 AWG	I_N 16 A, 400 V	5 mm / 0.197 in.	●	280-874	50
					●	280-881	50
					●	280-885 [Ⓢ]	50
					●	280-883	50
	4-conductor disconnect/test terminal block with shield contact and test slot for 2 mm and 2.3 mm Ø test plugs	0.08 ... 2.5 mm ² / 28 ... 12 AWG	I_N 16 A, 250 V	5 mm / 0.197 in.	●	280-875	50
					●	280-882	50
					●	280-884	50
	End and intermediate plate, 2.5 mm thick				●	280-373	100
					●	280-376	100
	2-conductor disconnect terminal block, with test point	0.2 ... 6 mm ² / 24 ... 10 AWG	I_N 30 A, 400 V	8 mm / 0.315 in.	●	282-697	25
					●	282-695	25
	Ground conductor disconnect terminal block with test point (circuit diagrams, see page 49)	0.2 ... 6 mm ² / 24 ... 10 AWG		16 mm / 0.63 in.	●	282-640	12
					●	282-641	12
					●	282-638	12
					●	282-639	12
	3-conductor through terminal block with test point, same profile as disconnect terminal blocks	0.2 ... 6 mm ² / 24 ... 10 AWG	I_N 41 A, 800 V	8 mm / 0.315 in.	●	282-699	25
					●	282-694	25
	End and intermediate plate, 2 mm thick				●	282-333	100
					●	282-334	100

For suitable jumpers, see page 72.

Classic Disconnect/Test Terminal Blocks for Current and Voltage Transformer Circuits – Description and Installation –

Shorting path preparation for current transformer circuits

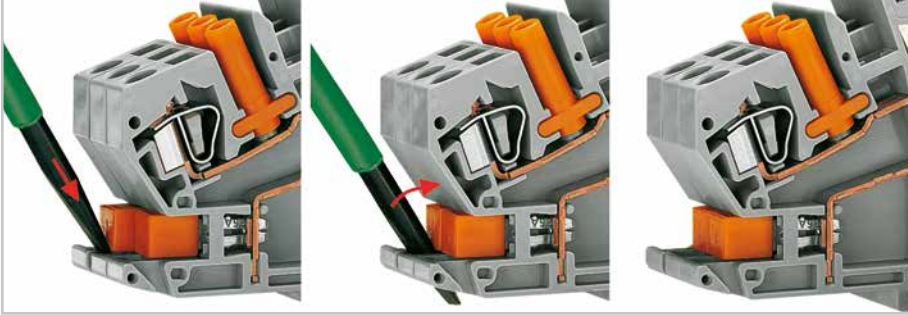

Inserting insulated, touch-proof adjacent jumpers into the protected shorting position.



Terminal strip permanently prepared for current transformer circuits

Lock-out



Lock-out snaps into one of two notched positions, preventing accidental operation of the disconnect link.

Locking cover for disconnect links



Snapping transparent locking cover onto 1-8 disconnect links:
a) Mechanically lock several links for multi-pole switching applications
b) Protect markers

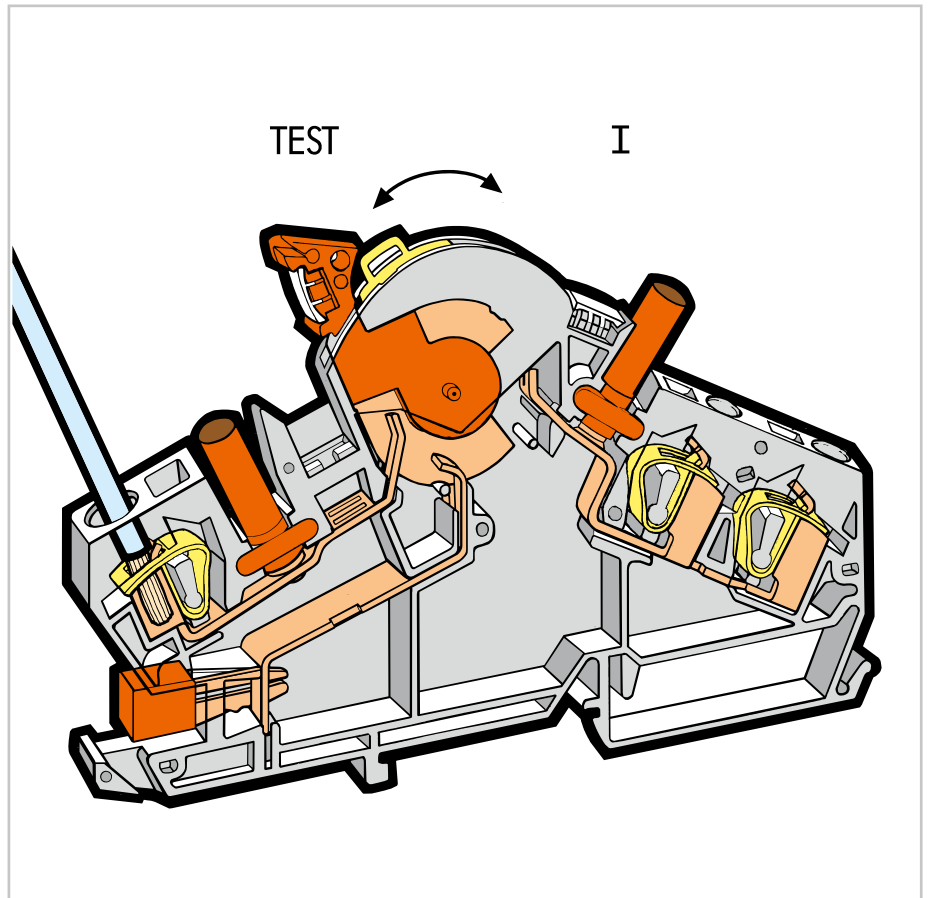

Interlocking link



Interlocking link mechanically locks multiple links for multi-pole switching applications.

Touch-proof test sockets



Touch-proof 4 mm Ø test plugs are not available from WAGO, but are offered by industry suppliers such as, Fabrikat Multi-Contact.

Marking

























Marking with WMB Multi marking system – for other systems, see Section 11.

For information on Push-in CAGE CLAMP® connection, see page 14.

Classic Disconnect/Test Terminal Blocks 6 (10) mm² and Through Terminal Blocks for Current and Voltage Transformer Circuits





282 Series

CAGE CLAMP®

	Description	Technical Data	Terminal Block Width	Color	Item No.	Pack. Unit
	2-conductor longitudinal switching disconnect/test terminal block with touch-proof test sockets, for 4 mm Ø test plugs	0.2 ... 6 mm ² / 24 ... 10 AWG I _N 30 A, 500 V	8 mm / 0.315 in.	●	282-821*	20
	2-conductor through terminal block with touch-proof test sockets for 4 mm Ø test plugs	0.2 ... 6 mm ² / 24 ... 10 AWG I _N 30 A, 500 V	8 mm / 0.315 in.	●	282-841*	20
	2-conductor through terminal block without test sockets			●	282-841/ 049-000*	20
	End and separator plate, 1.5 mm thick			●	282-365	50
	End and separator plate, 1.5 mm thick			●	282-360	50
	2-conductor transverse switching disconnect/test terminal block with touch-proof test socket for 4 mm Ø test plug	0.2 ... 6 mm ² / 24 ... 10 AWG I _N 30 A, 500 V	8 mm / 0.315 in.	●	282-811*	20
	End and separator plate, 1.5 mm thick			●	282-366	50
	End and separator plate, 1.5 mm thick			●	282-361	
	Circuit jumper for transverse switching terminal block (282-811), insulated, I _N 30 A	2-way ⋮ 6-way		●	282-442 ⋮ 282-446	50
	Jumper for 282 Series, insulated, I _N 30 A	2-way ⋮ 10-way		●	282-432 ⋮ 282-440	50
	Lock-out device for disconnect link			●	282-370	100
	Coupling device, mechanically locks multiple links	2-way ⋮ 4-way		●	282-372 ⋮ 282-374	50
* Installation instructions for 282-811/-821, see page 54.						
	Disconnect/test terminal block, e.g., current transformer circuits, with touch-proof test sockets	0.2 ... 6 mm ² / 24 ... 10 I _N 30 A, 500 V	8 mm / 0.315 in.	●	282-870	20
	Through terminal block, e.g., current transformer circuits, with touch-proof test socket	0.2 ... 6 mm ² / 24 ... 10 I _N 30 A, 500 V	8 mm / 0.315 in.	●	282-865	20
	End and separator plate, 1.5 mm thick, with lock-out seal option for disconnect terminal blocks			●	282-387	50
	End and separator plate, 1.5 mm thick, for through terminal blocks			●	282-392	50
	Disconnect/test terminal block, e.g., voltage circuits, with touch-proof test sockets	0.2 ... 6 mm ² / 24 ... 10 I _N 30 A, 500 V	8 mm / 0.315 in.	●	282-860	20
	Through terminal block, e.g., voltage transformer circuits, with touch-proof test socket	0.2 ... 6 mm ² / 24 ... 10 I _N 30 A, 500 V	8 mm / 0.315 in.	●	282-866	20
	End and separator plate, 1.5 mm thick, for through terminal blocks			●	282-385	50
	End and separator plate, 1.5 mm thick, for through terminal blocks			●	282-390	50
	Locking cover, transparent, mechanically locks multiple links	1-pole ⋮ 8-pole		○	282-881 ⋮ 282-888	50
	Adjacent jumper for disconnect/test terminal block (282-870), insulated, I _N 41 A			●	282-424	100
	Lock-out device for disconnect link			●	282-384	100

X-COM®-SYSTEM

769 and 870 Series

Technical data – carrier terminal blocks:	0.08 ... 4 mm ²	28 ... 12 AWG
	500 V/6 kV/3	300 V, 10 A 
	250 V/4 kV/3	300 V, 20 A 
	I _N 16 A / 32 A*	
	Terminal block width: 5 mm / 0.197 in.	
	 8 ... 9 mm / 0.33 in.	
	 Approvals	



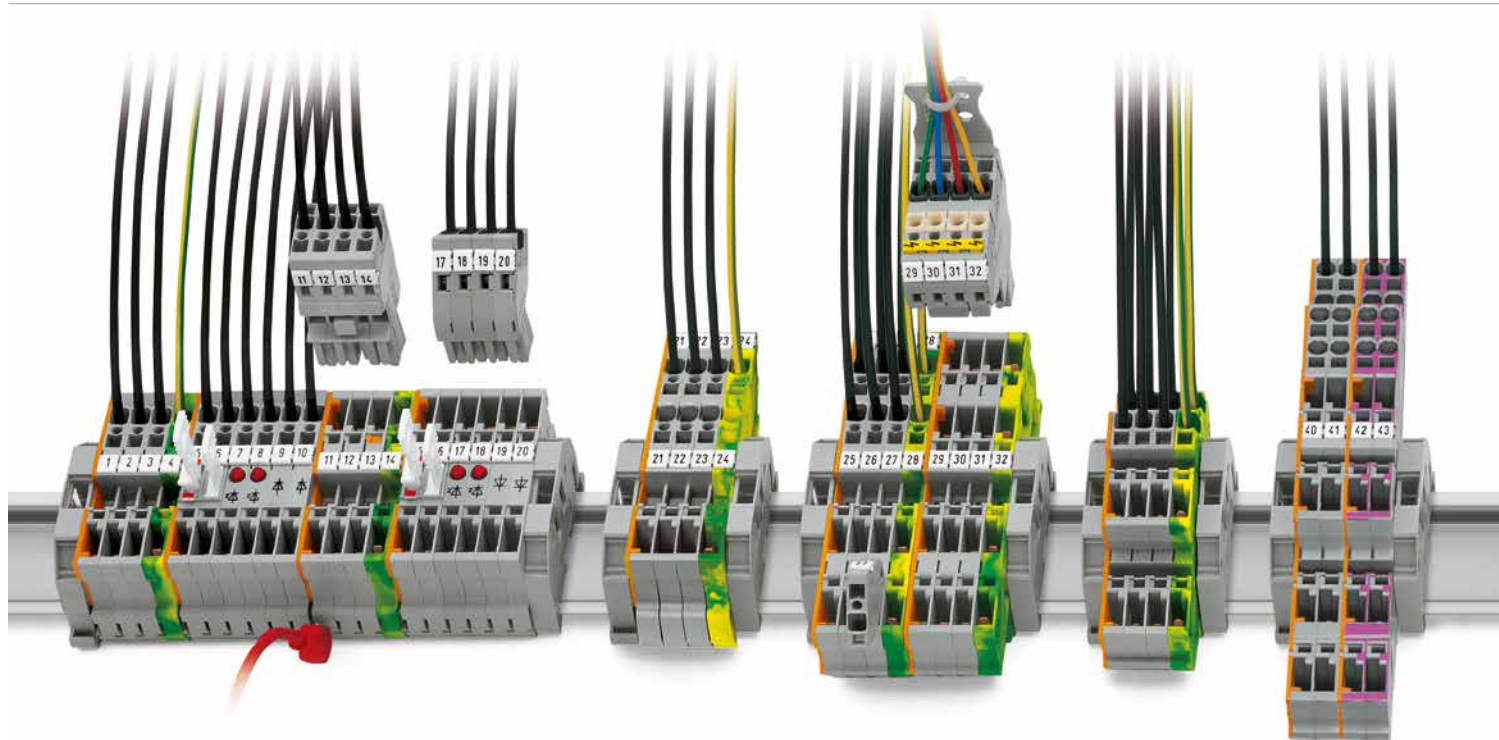

Female plug, with coding fingers	1-conductor, straight	1-conductor, angled	2-conductor, straight
○ 1-pole	769-101	769-101/022-000	769-121
○ 2-pole	769-102	769-102/022-000	769-122
:	:	:	:
○ 15-pole	769-115	769-115/022-000	769-135
● 1-pole	769-101/000-016	769-101/022-016	769-121/000-016



	Single-deck, through and function terminal blocks					Double-deck terminal blocks			
	1-cond./1-pin	2-pin	2-cond./1-pin	2-cond./2-pin	4-pin	1-cond./1-pin	2-pin/2-pin	2-cond./2-pin	4-cond./4-pin
○ Carrier terminal block	769-176*	769-156*	769-251*	769-171*	769-151*	870-101	870-151	870-131	
○ Carrier terminal block, internally commoned							4-pin	870-158	870-108 870-138
○ Carrier terminal block with shield contact	769-231*	769-221*		769-211*	769-201*		4-pin		
● Ground carrier terminal block	769-237	769-227	769-257	769-217	769-207	870-157	870-107		
○ Disconnect carrier terminal block	769-232	769-222							
○ Disconnect carrier terminal block with shield contact	769-233	769-223							
○ Diode carrier terminal block									
Anode, left side	769-238/281-410	769-228/281-410							
Anode, right side	769-238/281-411	769-228/281-411							
○ LED carrier terminal block									
Anode, right side	769-239/281-413	769-229/281-413							
Anode, left side	769-239/281-434	769-229/281-434							
○ End plate	769-307	769-305	769-320	769-301		870-118	870-168	870-148	
● End plate	769-308	769-306	769-321	769-302		870-119	870-169	870-149	
○ Separator, oversized									
○ Jumper	280-4xx	280-4xx	280-4xx	280-4xx	280-4xx	870-4xx	870-4xx	870-4xx	

 For all approvals and corresponding ratings, visit www.wago.com.

For technical explanations and abbreviations, see technical section.

Technical data – carrier terminal blocks:	0.08 ... 4 mm ²	28 ... 12 AWG
	500 V/6 kV/3	300 V, 10 A 
	250 V/4 kV/3	300 V, 20 A 
	I _N 16 A / 32 A*	
	Terminal block width: 5 mm / 0.197 in.	
	 8 ... 9 mm / 0.33 in.	
	 Approvals	

Strain relief plate, gray	Strain relief housing, gray
○ 1-pole 769-410	-
○ 2- to 3-pole 769-411	○ 2-pole 769-1602
○ 4- to 5-pole 769-412	○ 3-pole 769-1603
○ 6- to 9-pole 769-413	: :
○ 10- to 15-pole 769-414	○ 15-pole 769-1615



Terminal blocks with multiple jumper positions

3-way 1-cond./1-pin 769-214*	2-way 1-cond./1-pin	2-way 2-pin
	769-212	769-202
	769-213	769-203
769-218/281-410 769-218/281-411	769-208/281-410 769-208/281-411	
769-219/281-413 769-219/281-434	769-209/281-413 769-209/281-434	

Carrier terminal block for 280/281 Series pluggable modules (fuse, LED, ...)

1-cond./1-cond.	1-cond./1-pin	2-pin
769-191	769-181	769-161

Carrier terminal blocks for 286 Series pluggable modules with integrated end plate (relays, optocouplers, ...)

1-cond./1-pin	
4-pole	769-182/769-314
6-pole	769-183/769-314
8-pole	769-184/769-314
10-pole	769-185/769-314
1-cond./1-cond.	
4-pole	769-192/769-319
6-pole	769-193/769-319
8-pole	769-194/769-319
10-pole	769-195/769-319
2-pin	
4-pole	769-162/769-313
6-pole	769-163/769-313
8-pole	769-164/769-313
10-pole	769-165/769-313

769-315	769-311	769-309	1-cond./1-cond.	1-cond./1-pin	2-pin
769-316	769-312	769-310	769-317	769-311	769-309
			769-318	769-312	769-310
280-4xx	769-314	769-313	769-319	769-314	769-313
	280-4xx	280-4xx	780-45x	780-45x	780-45x

Please find the entire product range in our Full Line Catalog. For additional information, visit www.wago.com.

Matrix Patchboards

– Description and Installation –

CAGE CLAMP® connection

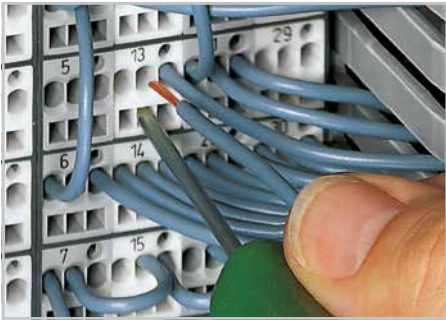

Conductor termination via operating tool (2.5 x 0.4 mm blade)

Module marking



Factory-marked modules
Side 1: 1, 2, 3, 4 ...

Testing



Testing via 2.3 mm Ø test plug.

Common potential matrix patch-board



Example shows common potential matrix patchboard (white) with supply terminal block.

Marking



WFB continuous marking strip – fits into the matrix patchboards' marker slot and group marker carrier.



Marking



Individual group marking via WSB quick marking system

Additional module



Snapping on additional module with contact to mounting frame.

Additional module









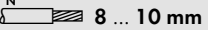

Assembling a matrix patchboard with additional module – direct connection to the mounting frame.



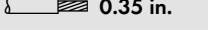

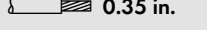
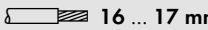



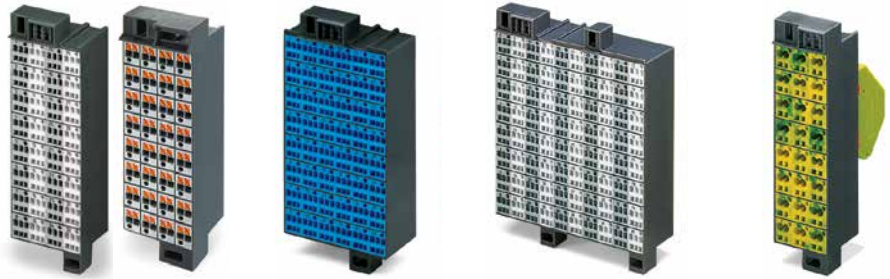





























For information on Push-in CAGE CLAMP® connection, see page 14.

Matrix Patchboards 726 Series

PUSH-IN CAGE CLAMP®
CAGE CLAMP®

















	500 V/6 kV/3 I_N 10 A  8 ... 10 mm 300 V, 10 A   0.35 in.	500 V/6 kV/3 I_N 10 A  8 ... 10 mm 300 V, 10 A   0.35 in.	500 V/6 kV/3 I_N 10 A  8 ... 10 mm 300 V, 10 A   0.35 in.	Side 1: I_N 76 A 2 x 0.2 ... 16 mm²  16 ... 17 mm Side 2: I_N 24 A 2 x 0.08 ... 2.5 mm²  8 ... 18 mm
--	--	--	--	---



Description	Marking	Color	Item No.	Pack.	Unit	Color	Item No.	Pack.	Unit	Color	Item No.	Pack.	Unit	Color	Item No.	Pack.	Unit
Matrix patchboard , dark gray housing, gray/white/blue modules, vertical module marking on sides 1 and 2	1 ... 32	32-pole				48-pole				80-pole							
Side 1: 3 x 0.08 ... 1.5 mm ² /28 ... 16 AWG	33 ... 64	 	726-121	20			726-141	1	20								
Side 2: 3 x 0.08 ... 1.5 mm ² /28 ... 16 AWG	1 ... 48	 	726-122	20			726-142	1	20								
	1 ... 80					 	726-421	10			726-441	1	10	 	726-721	8	
											726-741	1	8				
Matrix patchboard	1 ... 32	 	726-221	20													
Side 1: 3 x 0.08 ... 1.5 mm ² /28 ... 16 AWG	33 ... 64		726-241	1	20												
Side 2: 2 x 0.08 ... 2.5 mm ² /28 ... 14 AWG	1 ... 48	 	726-222	20			726-242	1	20								
	1 ... 80					 	726-521	10			726-541	1	10	 	726-821	8	
											726-841	1	8				
Matrix patchboard , slimline version, for 19" racks	1 ... 32	 	726-321	24													
Side 1: 2 x 0.08 ... 1.5 mm ² /28 ... 16 AWG	33 ... 64		726-341	1	24												
Side 2: 2 x 0.08 ... 1.5 mm ² /28 ... 16 AWG	1 ... 48	 	726-322	24			726-342	1	24								
	1 ... 80																
Common potential matrix patchboard , slimline version, for 19" racks, dark gray frame, gray/white/green-yellow modules, vertical module marking, with 1 or 2 supply terminal blocks for 76 A incl. end plate	1 ... 24													24-pole		726-601	10
Side 1: 2 x 0.08 ... 1.5 mm ² /28 ... 16 AWG																726-611	10
Side 2: 2 x 0.08 ... 1.5 mm ² /28 ... 16 AWG																726-621	10
																726-602	10
																726-612	10
																726-622	10
Matrix patchboard , slimline version, for 19" racks, with push-buttons and Push-in CAGE CLAMP®, without marking		18-pole				32-pole				54-pole							
Side 1: 2 x 0.2 ... 1.5 mm ² /28 ... 16 AWG			726-750	20			726-770	20			726-850	10					
Side 2: 2 x 0.2 ... 1.5 mm ² /28 ... 16 AWG																	

Accessories, 726 Series

(Marking and mounting accessories, see Full Line Catalog)

 <p>can be snapped to the lower mounting element, with CAGE CLAMP® connection, with contact to mounting frame</p>	 <p>Insulation stop, 4 x 3 pcs/strip</p>	<p>0.08 ... 0.2 mm² "s" (0.14 mm² "f-st")</p> <p> 726-901 200</p> <p>0.25 mm² "s" 0.14 ... 0.25 mm² "f-st"</p> <p> 726-906 200</p> <p>0.25 ... 0.5 mm² "s+f-st"</p> <p> 726-907 200</p>	<p>Test plug, with 500 mm cable</p> <p> </p> <p> 2 mm Ø 210-136 50</p> <p> 2.3 mm Ø 210-137 50</p>
	<p></p> <p> 726-903 25</p> <p> 726-904 25</p>	<p>Step-down test plug, from 4 mm socket to 2 mm plug</p> <p>  210-297 100 (4x25)</p>	
<p>Decade marker carrier, for matrix patchboards</p> <p> 726-905 10</p>	<p>Operating tool with a partially insulated shaft, type 1, (2.5 x 0.4) mm blade</p> <p> 210-719 1</p>		

① Suitable for Ex i applications

Terminal Blocks for Matrix Patching and Common Potential Terminal Blocks – Description and Installation –

CAGE CLAMP® connection

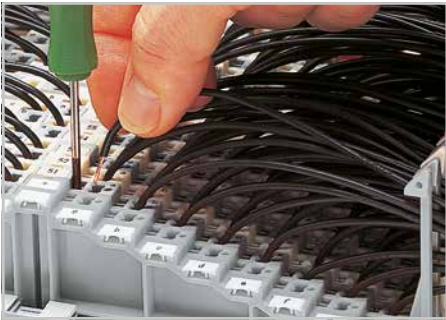

Inserting/removing conductor via operating tool (2.5 x 0.4 mm blade).

Wiring space



Using terminal blocks with locking clips, the wiring space between the terminal strips can be covered with a wiring duct cover.

Assembly

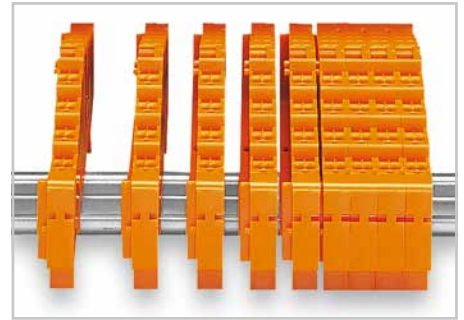

Snap individual 4- or 8-level terminal blocks onto the carrier rail. Slide terminal blocks together.

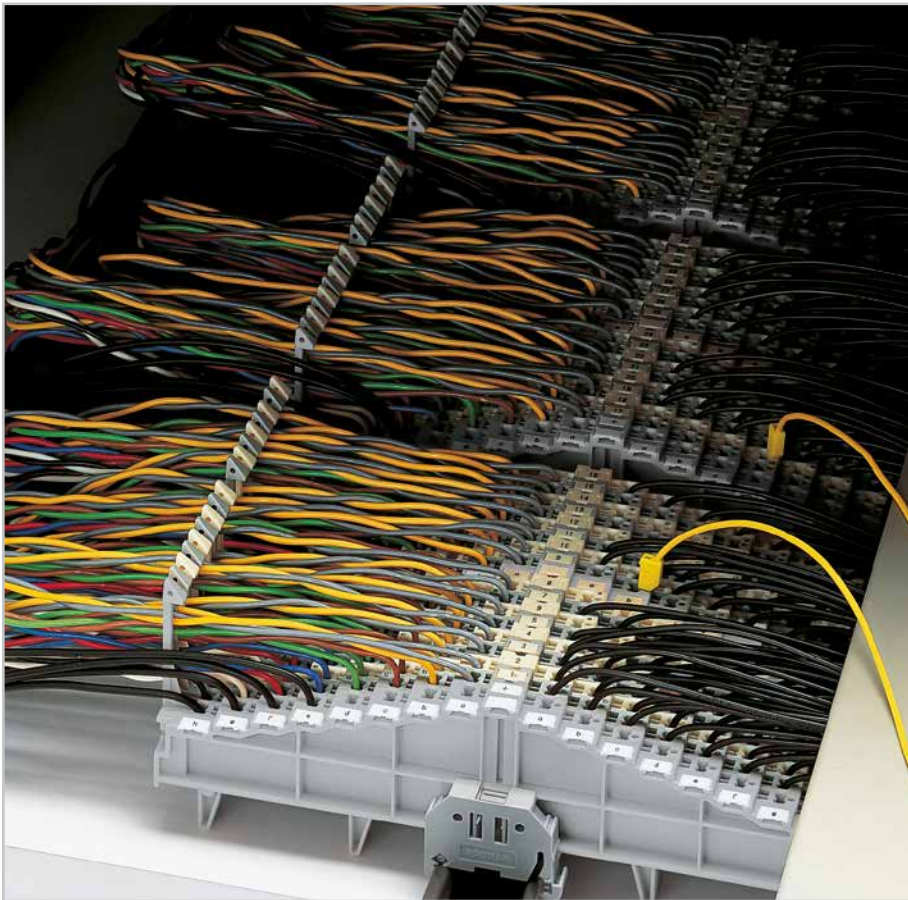

Assembly/Removal



Grip end plate at both sides and
– push down (assembly)
– pull up (removal)

Removal



Open the assembly by laterally sliding a block via operating tool (2.5 x 0.4 mm blade). Slide terminal block and remove from the rail with a levering action.

Marking

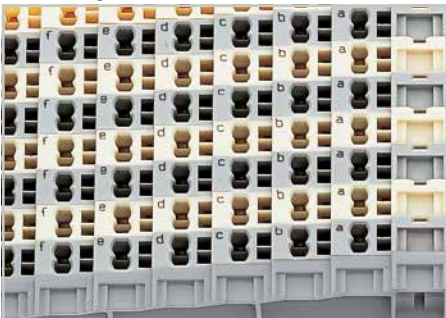

Mark of clamping points with direct printing.

Marking

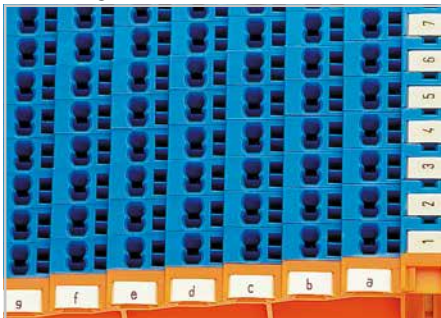

Marking coordinates via WMB Multi Marking System.











Testing



Special test contact for 2 mm or 2.3 mm Ø test plug, as well as step-down test plug with 4 mm socket

CAGE CLAMP®





































































4- and 8-Level Matrix Patching/Common Potential Terminal Blocks, 1.5 mm² 727 Series

Terminal block for matrix patching, 4 x pairs of clamping units on the same level	0.08 ... 1.5 mm ² 250 V/4 kV/3 I _N 12 A	28 ... 16 AWG 300 V, 10 A  300 V, 10 A 	0.08 ... 1.5 mm ² 250 V/4 kV/3 I _N 12 A	28 ... 16 AWG 300 V, 10 A  300 V, 10 A 
Common potential terminal block, all clamping units are connected to the same current bar	Terminal block width: 7.62 mm / 0.3 in.  8 ... 10 mm / 0.35 in.	 8 ... 10 mm / 0.35 in.	Terminal block width: 7.62 mm / 0.3 in.  8 ... 10 mm / 0.35 in.	 8 ... 10 mm / 0.35 in.
	 Approvals	 Approvals		













4-level terminal block for matrix patching

8-level common potential terminal block

Description	Marking	Color	Item No.	Pack. Unit	Color	Item No.	Pack. Unit	Color	Item No.	Pack. Unit	Color	Item No.	Pack. Unit				
Matrix patching/common potential terminal block without locking clips, for DIN 35 x 7.5 rail per EN 60715		4 levels				8 levels				4 levels				8 levels			
			727-220	50		727-120	25		727-226	50		727-126	25				
			727-222	50		727-122	25		727-228	50		727-128	25				
			727-224 	50		727-124 	25										
Matrix patching/common potential terminal block without locking clips, for DIN 35 x 15 rail per EN 60715		4 levels				8 levels				4 levels				8 levels			
			727-230	50		727-130	25		727-236	50		727-136	25				
			727-232	50		727-132	25		727-238	50		727-138	25				
			727-234 	50		727-134 	25										
Matrix patching/common potential terminal block with locking clips, for DIN 35 x 7.5 rail per EN 60715		4 levels				8 levels				4 levels				8 levels			
			727-219	50		727-119	25		727-225	50		727-125	25				
			727-221	50		727-121	25		727-227	50		727-127	25				
			727-223 	50		727-123 	25										
Matrix patching/common potential terminal block with locking clips, for DIN 35 x 15 rail per EN 60715		4 levels				8 levels				4 levels				8 levels			
			727-229	50		727-129	25		727-235	50		727-135	25				
			727-231	50		727-131	25		727-237	50		727-137	25				
			727-233 	50		727-133 	25										
End plate, 7.62 mm		4 levels				8 levels				4 levels				8 levels			
					727-217	25				727-217	25				727-117	25	
			Marking: 0-1-2-3-3-2-1-0		727-205	25				727-205	25				727-105	25	
	Marking: a-b-c-d-d-c-b-a		727-206	25				727-206	25				727-106	25			
End plate, 7.62 mm		4 levels				8 levels				4 levels				8 levels			
					727-117	25				727-117	25				727-117	25	
			Marking: 0-1-2-3-4-5-6-7-7-6-5-4-3-2-1-0		727-105	25				727-105	25				727-105	25	
	Marking: a-b-c-d-e-f-g-h-h-g-f-e-d-c-b-a		727-106	25				727-106	25				727-106	25			
Item no. suffixes for terminal blocks with marking:																	
0-1-2-3-3-2-1-0		.../021-000				.../021-000				.../021-000							
a-b-c-d-d-c-b-a		.../022-000				.../022-000				.../022-000							
3-2-1-0-0-1-2-3		.../023-000				.../023-000				.../023-000							
d-c-b-a-a-b-c-d		.../024-000				.../024-000				.../024-000							
0-1-2-3-4-5-6-7-7-6-5-4-3-2-1-0		.../021-000				.../021-000				.../021-000							
a-b-c-d-e-f-g-h-h-g-f-e-d-c-b-a		.../022-000				.../022-000				.../022-000							
7-6-5-4-3-2-1-0-0-1-2-3-4-5-6-7		.../023-000				.../023-000				.../023-000							
h-g-f-e-d-c-b-a-a-b-c-d-e-f-g-h		.../024-000				.../024-000				.../024-000							

Accessories, 727 Series

(Marking and mounting accessories, see Full Line Catalog)

Insulation stop , 8 pcs/strip  0.08 ... 0.2 mm ² "s" (0.14 mm ² "f-st")  727-197 200 0.25 mm ² "s" 0.14 ... 0.25 mm ² "f-st"  727-198 200 0.25 ... 0.5 mm ² "s+f-st"  727-199 200	Operating tool with a partially insulated shaft , type 1, (2.5 x 0.4) mm blade  210-719 1
	Test plug , with 500 mm cable   2 mm Ø 210-136 50  2.3 mm Ø 210-137 50
	Wire commoning chain , insulated, 31 connections,  I _N 6 A, max. 50 V, 0.5 mm ²  709-107 1

 For all approvals and corresponding ratings, visit www.wago.com.

For technical explanations and abbreviations, see technical section.

 Suitable for Ex i applications

Busbar Terminal Blocks – Description and Installation –

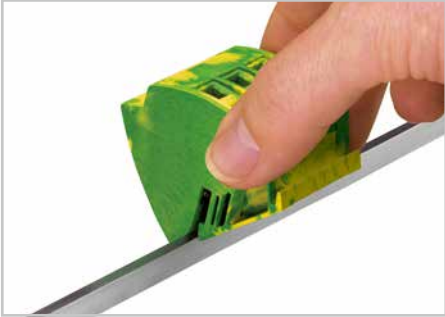

Snapping a ground busbar terminal block onto the N-busbar



Unlock right and left positions to remove the ground busbar terminal block. Then pull up the block from the busbar.

Using the 812 Series Busbar Terminal Blocks in switchgear cabinets and distribution boards permits simple and safe potential distribution on standard 10 x 3 mm busbars. Tool-free snapping of self-locking busbar terminal blocks onto the busbar enables quick and easy assembly, as well as subsequent extension. The busbar terminal blocks are available in two different versions for conductors ranging from 1.5–16 mm² (16–6 AWG). Current carrying capacity: With a maximum total current of 96 A, the clamping units of the busbar terminal block can be loaded with the rated current of the conductor cross-sections approved. This only applies when 10 x 3 mm busbars are used.

Conductor termination (4 mm²)

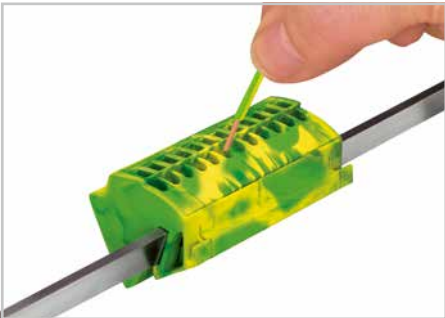

With Push-in CAGE CLAMP®, solid conductors can be terminated by simply pushing them into the 12 x 4 mm² busbar terminal block, significantly reducing wiring time.

Conductor termination (16 mm²)



Open the clamping unit with an operating tool when terminating solid, stranded and fine-stranded conductors.

Conductor removal (4 mm² and 16 mm²)

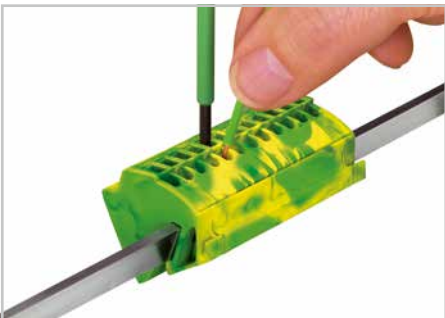

Open the clamping unit using an operating tool.

Mixed 4 mm² and 16 mm² busbar terminal blocks

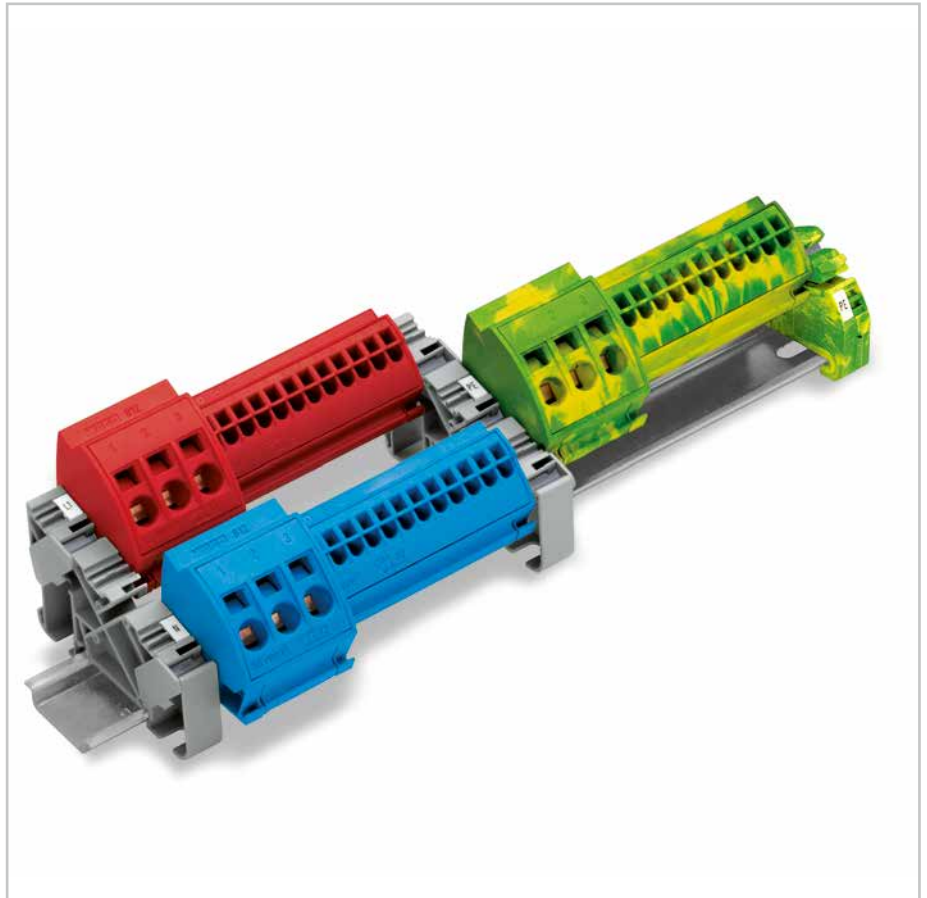

Busbar carrier

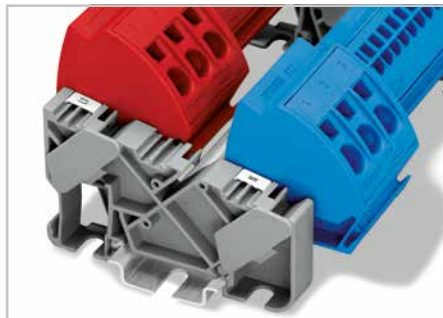

Carrier with 3 receptacles for 10 x 3 mm busbars with locking device for easy mounting of the busbars. The carriers can be snapped onto the DIN-35 rail or screwed on a panel.

Ground busbar carrier

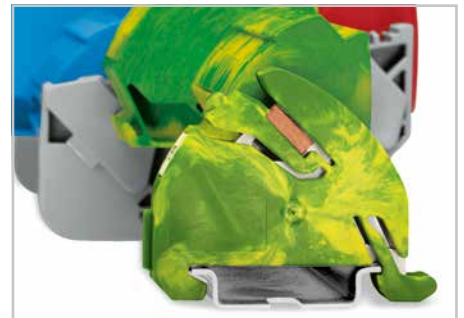







Carrier including a receptacle with locking device for (10 x 3) mm busbar. Contact between the busbar and rail is made automatically by simply snapping the carrier onto the carrier rail. One end of the busbar is mounted onto the ground busbar carrier, the other end is inserted into the middle position of the insulated busbar carrier.

Busbar Terminal Blocks

4 mm² and 16 mm²

812 Series

PUSH-IN CAGE CLAMP®
CAGE CLAMP®

0.5 ... 4 mm² 1000 V/6 kV/3 I _N 96 A Terminal block width: 75 mm / 2.953 in.  11 mm / 0.43 in. 1 Approvals	20 ... 12 AWG 600 V, 20 A  600 V, 95 A 	1.5 ... 16 mm² 1000 V/6 kV/3 I _N 96 A Terminal block width: 38 mm / 1.496 in.  12 mm / 0.47 in. 1 Approvals	14 ... 6 AWG 600 V, 20 A  600 V, 95 A 	Insulated busbar carrier
--	--	---	---	---------------------------------

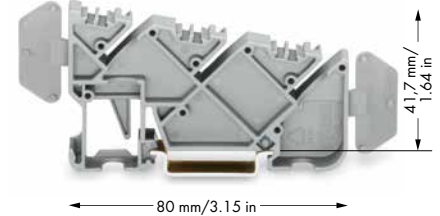
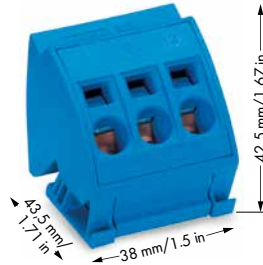

Color	Item No.	Pack. Unit	Color	Item No.	Pack. Unit	Color	Item No.	Pack. Unit
Busbar terminal block 4 mm² with Push-in CAGE CLAMP®			Busbar terminal block 16 mm² with CAGE CLAMP®			Insulated busbar carrier, 12 mm wide		
● blue	812-104	10	● blue	812-114	12	○ gray	812-140	25
○ light gray	812-101	10	○ light gray	812-111	12			
● dark gray	812-102	10	● dark gray	812-112	12			
● red	812-103	10	● red	812-113	12			

Item-Specific Accessories
Straight busbar, Cu with tin plating,

 10 x 3 mm,
 1000 mm long
 I_N 140 A **210-133** 1

Item-Specific Accessories
Straight busbar, Cu with tin plating,

 10 x 3 mm,
 1000 mm long
 I_N 140 A **210-133** 1

Item-Specific Accessories
WMB Multi marking system, plain,

 10 strips with 10 markers per card,
 stretchable from 5 ... 5.2 mm
793-5501 5

WMB Inline, plain,

 stretchable from 5 ... 5.2 mm,
 1500 WMB markers (5 mm) per roll
2009-115 1

Finger guard,

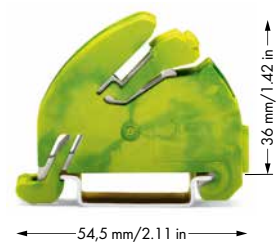
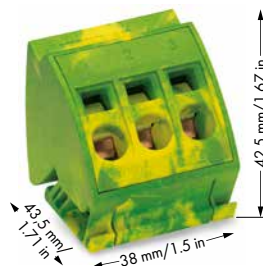
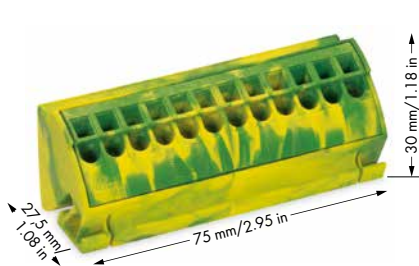
 touch-proof cover protects unused
 conductor entries
 ● **284-400** 100 (4x25)

Color	Item No.	Pack. Unit	Color	Item No.	Pack. Unit	Color	Item No.	Pack. Unit
Ground busbar terminal block 4 mm² with Push-in CAGE CLAMP®			Ground busbar terminal block 16 mm² with CAGE CLAMP®			Ground busbar carrier with DIN-35 rail contact, 11 mm wide		
● green-yellow	812-100	10	● green-yellow	812-110	12	● green-yellow	812-141	25

Item-Specific Accessories
Straight busbar, Cu with tin plating,

 10 x 3 mm,
 1000 mm long
 I_N 140 A **210-133** 1

Item-Specific Accessories
Straight busbar, Cu with tin plating,

 10 x 3 mm,
 1000 mm long
 I_N 140 A **210-133** 1

Accessories
Operating tool with a partially insulated shaft,

 type 2, (3.5 x 0.5) mm blade
210-720 1

Finger guard,

 touch-proof cover protects unused
 conductor entries
 ● **284-400** 100 (4x25)

Modular Terminal Blocks and Terminal Strips, Side-Entry – Description and Installation –

Assembly

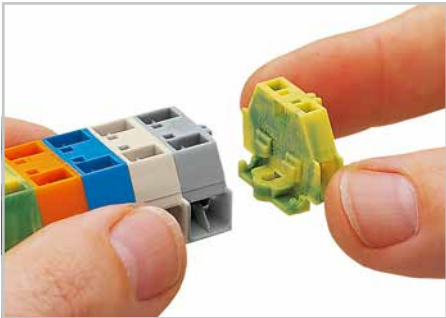

Assembling modular terminal blocks into terminal strips.

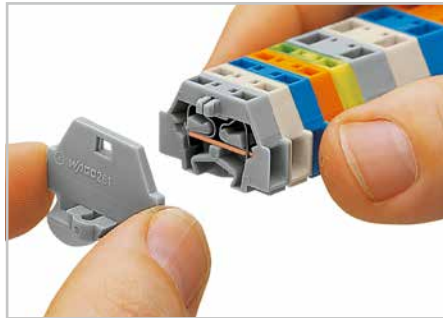

Mounting an end plate.

Mounting

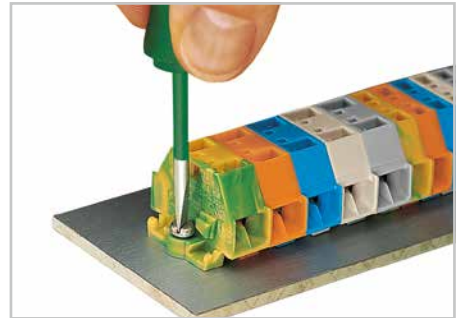

Mounting and securing a terminal strip directly to the plate via screw-type flanges.

CAGE CLAMP® connection

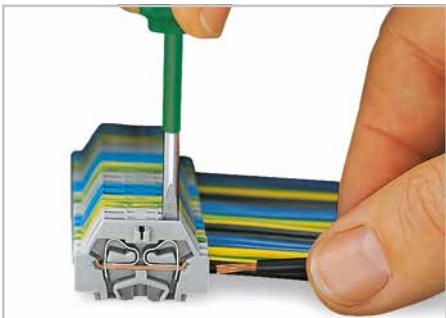

Inserting a conductor via operating tool.

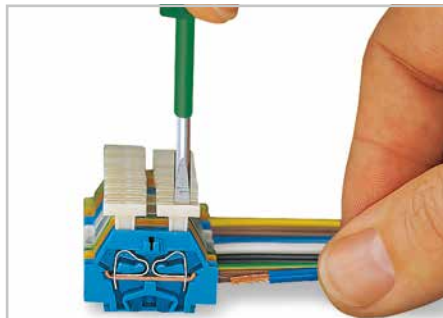

Inserting a conductor via push-button.

Mounting



Securing a mounting foot (209-123) to the terminal strip with mounting flanges (distance between mounting feet: approx. 35 ... 40 mm).

Marking



Marking with self-adhesive marking strips.

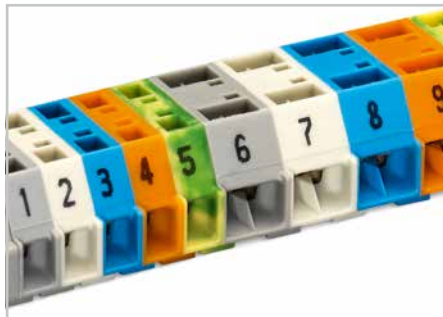

Marking by direct printing (upon request).

Mounting

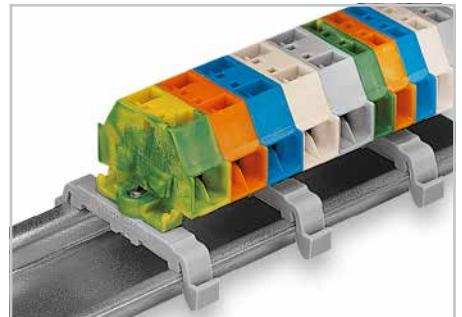

Terminal strip with mounting flanges, on DIN-35 rail

Types

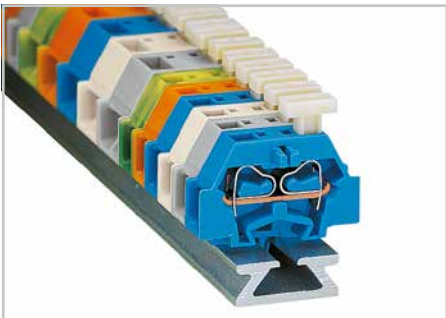

Terminal strip with push-buttons on one side.

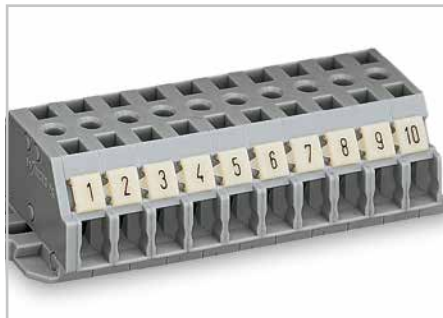

Terminal strip with marker slot for Miniature WSB Quick Marking System (see Full Line Catalog).

Commoning

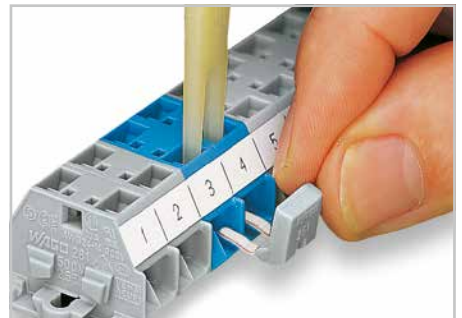

Commoning with comb-style jumper bar.

For information on Push-in CAGE CLAMP® connection, see page 14.

Modular Terminal Blocks and Terminal Strips

260 ... 262 Series

<p>0.08 ... 1.5 mm² 400 V/6 kV/3 I_N 18 A 2-cond. terminal block width: 5 mm/0.197 in. 4-cond. terminal block width: 8 mm/0.315 in. 8 ... 9 mm / 0.33 in. ① Approvals</p>	<p>28 ... 16 AWG 300 V, 10 A 300 V, 15 A </p>	<p>0.08 ... 2.5 mm² 500 V/6 kV/3 I_N 24 A 2-cond. terminal block width: 6 mm/0.236 in. 4-cond. terminal block width: 10 mm/0.394 in. 8 ... 9 mm / 0.33 in. ① Approvals</p>	<p>28 ... 14 AWG 300/600 V, 15 A 300/600 V, 20 A </p>	<p>0.08 ... 4 mm² 630 V/8 kV/3 I_N 24 A ② (32 A ③) 2-cond. terminal block width: 7 mm/0.276 in. 4-cond. terminal block width: 12 mm/0.472 in. 9 ... 10 mm / 0.37 in. ① Approvals</p>	<p>28 ... 12 AWG 300/600 V, 20 A 300/600 V, 20 A </p>
--	--	---	--	---	--

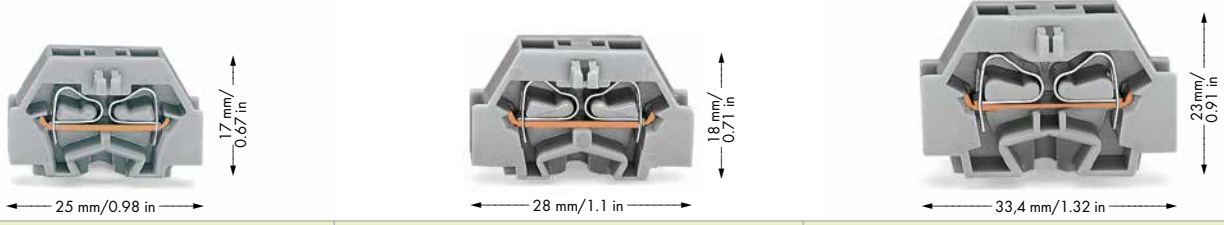

Color	Item No.	Pack. Unit	Color	Item No.	Pack. Unit	Color	Item No.	Pack. Unit			
gray	260-301	260-331	300 (6x50)	gray	261-301	261-331	200 (4x50)	gray	262-301	262-331	100 (2x50)
light gray	260-303	260-333	300 (6x50)	light gray	261-303	261-333	200 (4x50)	light gray	262-130	262-230	100 (2x50)
blue	260-304	260-334	300 (6x50)	blue	261-304 ④	261-334 ④	200 (4x50)	blue	262-304 ④	262-334 ④	100 (2x50)
orange	260-306	260-336	300 (6x50)	orange	261-306	261-336	200 (4x50)	orange	262-306	262-336	100 (2x50)
green-yellow	260-307	260-337	300 (6x50)	green-yellow	261-307	261-337	200 (4x50)	green-yellow	262-307	262-337	100 (2x50)

Versions with push-buttons, see bottom right



Pole No.	Item No.	Pack. Unit	Pole No.	Item No.	Pack. Unit	Pole No.	Item No.	Pack. Unit			
	2-Cond. Block	4-Cond. Block		2-Cond. Block	4-Cond. Block		2-Cond. Block ②	4-Cond. Block ③			
Terminal strip with mounting flanges, gray			Terminal strip with mounting flanges, gray			Terminal strip with mounting flanges, gray					
2	260-102	260-202	100	2	261-102	261-202	100	2	262-102	262-202	100
3	260-103	260-203	100	3	261-103	261-203	100	3	262-103	262-203	100
:	:	:		:	:		:	:		:	
12	260-112	260-212	25	12	261-112	261-212	25	12	262-112	262-212	25

Accessories, 260/261/262 Series

Appropriate marking system, see page 244

<p>End plate with mounting flange, gray for 260 Series 260-361 100 (2x50) for 261 Series 261-361 100 (2x50) for 262 Series 262-361 50</p>	<p>Mounting foot with screw, for DIN-35 rail, 6 mm wide, can be screwed on terminal blocks with mounting flange 209-123 25</p>	<p>Item no. suffixes for terminal blocks and terminal strips with push-buttons (for 261 Series only) Push-buttons on one side: 2-Cond. Block 261-.../331-000 4-Cond. Block 261-.../332-000</p>																																					
<p>Comb-style jumper bar, insulated, 2-way </p>	<p>Test plug module 100 (4x25)</p>	<p>Push-buttons on both sides: 2-Cond. Block 261-.../341-000 4-Cond. Block 261-.../342-000</p>																																					
<table border="1"> <thead> <tr> <th>Series</th> <th>I_N</th> <th>Reduc. Cross Sect.</th> <th>Pack. Unit</th> </tr> </thead> <tbody> <tr> <td>260-402</td> <td>10 A</td> <td>1 mm²/18 AWG</td> <td>25 pcs</td> </tr> <tr> <td>261-402</td> <td>16 A</td> <td>1.5 mm²/16 AWG</td> <td>25 pcs</td> </tr> <tr> <td>262-402</td> <td>16 A</td> <td>2.5 mm²/14 AWG</td> <td>25 pcs</td> </tr> </tbody> </table>	Series	I _N	Reduc. Cross Sect.	Pack. Unit	260-402	10 A	1 mm ² /18 AWG	25 pcs	261-402	16 A	1.5 mm ² /16 AWG	25 pcs	262-402	16 A	2.5 mm ² /14 AWG	25 pcs	<p>Locking devices</p> <table border="1"> <thead> <tr> <th>Series</th> <th>with</th> <th>without</th> </tr> </thead> <tbody> <tr> <td>260 / 5 mm</td> <td>260-404</td> <td>249-135</td> </tr> <tr> <td>8 mm</td> <td>260-405</td> <td>249-138</td> </tr> <tr> <td>261 / 6 mm</td> <td>261-404</td> <td>249-136</td> </tr> <tr> <td>10 mm</td> <td>261-405</td> <td>249-139</td> </tr> <tr> <td>262 / 7 mm</td> <td>261-405</td> <td>249-137</td> </tr> <tr> <td>12 mm</td> <td>261-405</td> <td>249-140</td> </tr> </tbody> </table>	Series	with	without	260 / 5 mm	260-404	249-135	8 mm	260-405	249-138	261 / 6 mm	261-404	249-136	10 mm	261-405	249-139	262 / 7 mm	261-405	249-137	12 mm	261-405	249-140	<p>Operating tool with a partially insulated shaft, type 2, (3.5 x 0.5) mm blade 210-720 1</p>
Series	I _N	Reduc. Cross Sect.	Pack. Unit																																				
260-402	10 A	1 mm ² /18 AWG	25 pcs																																				
261-402	16 A	1.5 mm ² /16 AWG	25 pcs																																				
262-402	16 A	2.5 mm ² /14 AWG	25 pcs																																				
Series	with	without																																					
260 / 5 mm	260-404	249-135																																					
8 mm	260-405	249-138																																					
261 / 6 mm	261-404	249-136																																					
10 mm	261-405	249-139																																					
262 / 7 mm	261-405	249-137																																					
12 mm	261-405	249-140																																					
<p>Operating tool, insulated, for comb-style jumper bar 2-way 209-132 1</p>	<p>④ Suitable for Ex i applications Suitable for Ex e II applications</p>																																						

① For all approvals and corresponding ratings, visit www.wago.com.

For technical explanations and abbreviations, see technical section.

Modular Terminal Blocks and Terminal Strips, Front-Entry – Description and Installation –

Assembly

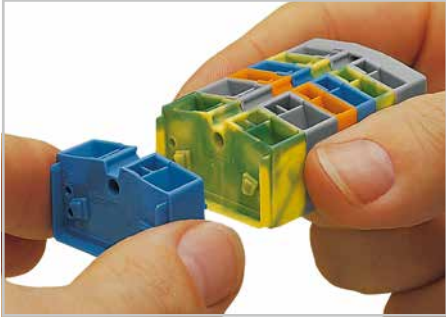

Assembling modular terminal blocks into terminal strips.

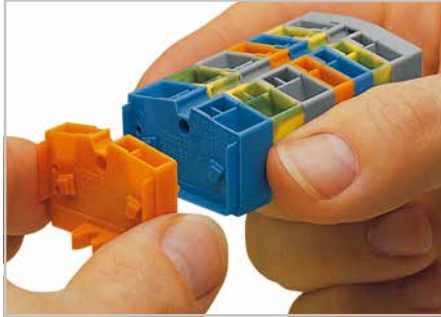

Mounting an "end terminal block" with mounting flange.

Mounting



Mounting and securing a terminal strip directly to the plate via screw-type flanges.

CAGE CLAMP® connection



Inserting a conductor via operating tool.

Removal

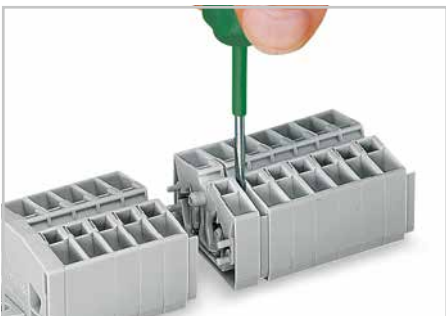

Removing a terminal block.

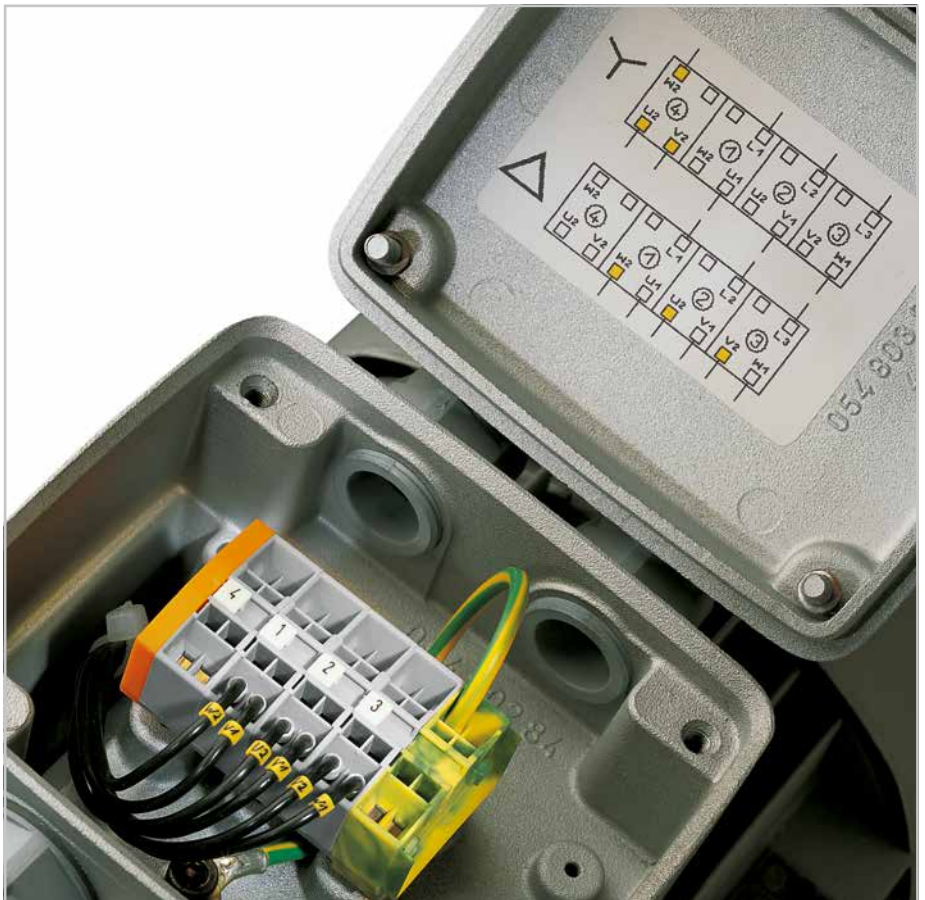

Commoning

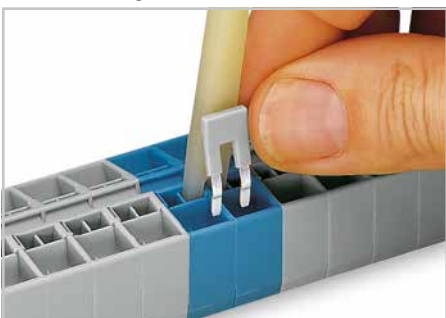

Commoning with a comb-style jumper bar.

Testing

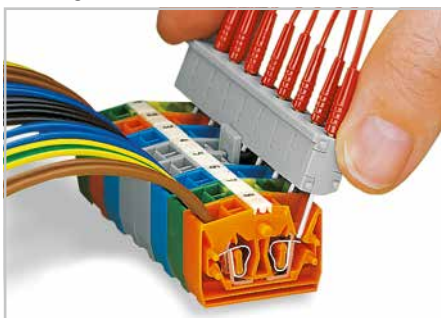

Testing with test plug module assembly – touch contact.

Marking

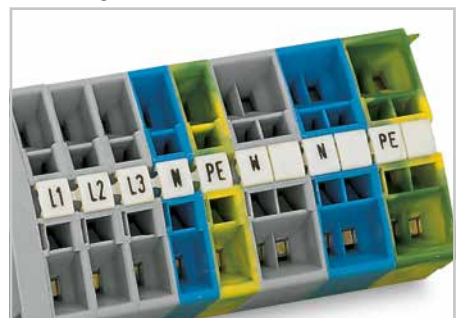

Marking using Miniature WSB Quick markers.

For information on Push-in CAGE CLAMP® connection, see page 14.

4-Conductor, Chassis-Mount Terminal Strips – Description and Installation –

Conductor termination

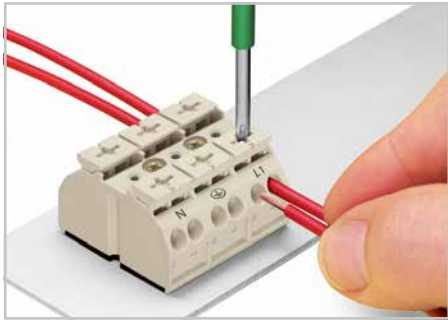

Four conductors per pole for solid and fine-stranded conductors

Marking

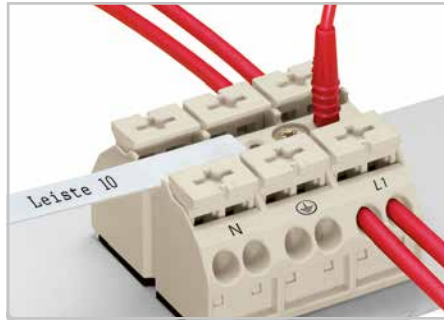

Marking by direct, one-side printing and/or marking strips.

Testing

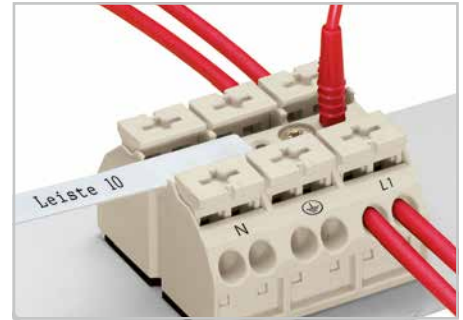

Testing with 2 mm Ø test plug.

Ground (PE) contact



Makes an automatic contact to the mounting plate. The varnish coating is instantly penetrated.

Commoning



Commoning with comb-style jumper bar.

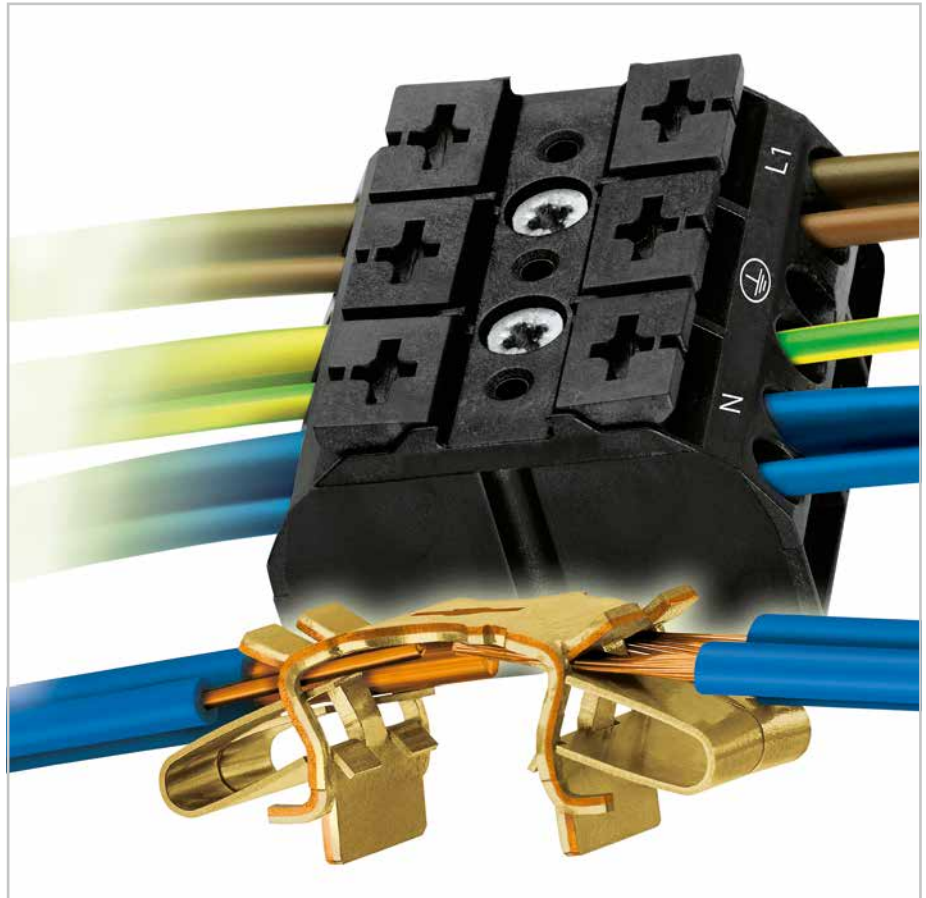

Cost-effective features:

The 862 Series Chassis-Mount Terminal Strips were developed specifically to **minimize wiring costs**, while accommodating requirements for flexible mounting, multiple connection points and easy handling:

- The 862 Series equipped with Push-in CAGE CLAMP® connects up to four conductors sized 20 ... 12 AWG (0.5 ... 4 mm²). Due to multiple connection points per pole, different conductor sizes can be used within the same terminal block position.
- For factory wiring, Push-in CAGE CLAMP® Connection Technology allows solid conductors, fine-stranded conductors with ferrules or ultrasonically bonded conductors from 20 ... 12 AWG (0.5 ... 4mm²) to be terminated by simply pushing them into unit (length of bonded conductor end: min. 10 mm)
- Convenient automatic grounding contact available as an option
- Snap-in mounting feet for fast assembly
- Push-buttons for easy installation with an operating tool or by hand
- Built-in test points simplify testing with 2 mm Ø test plug
- Flexible marking options with standard marking (pre-marked), marking strip or custom marked for large orders

For information on Push-in CAGE CLAMP® connection, see page 14.

4-Conductor, Chassis-Mount Terminal Strips

2-, 3-, 4- and 5-Pole, 4 mm²

862 Series

PUSH-IN CAGE CLAMP®

	0.5 ... 4 mm ² ① 500 V/6 kV/3 I _N 32 A	20 ... 12 AWG 300 V, 20 A ② 300 V, 20 A ③	0.5 ... 4 mm ² ① 500 V/6 kV/3 I _N 32 A	20 ... 12 AWG 300 V, 20 A ② 300 V, 20 A ③
	10 ... 11 mm / 0.41 in.		10 ... 11 mm / 0.41 in.	
	② Approvals		② Approvals	

① Conductor range: 0.25 ... 4 mm² "s+st"
Push-in termination: 0.75 ... 4 mm² "s" and
0.75 ... 2.5 mm² "insulated ferrule, 12 mm"

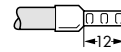

Available in white and black housings

2- and 3-pole

4- and 5-pole

	without Ground (PE) contact	with Ground (PE) contact	Marking	Item No. black	Item No. white	Pack. Unit	Marking	Item No. black	Item No. white	Pack. Unit
For fastening with a screw and nut (M3) or a self-tapping screw (2.9 mm Ø) from top,										
	without ground contact		without	● 862-552	○ 862-652	500	without	● 862-504	○ 862-604	200
			L1-N	● 862-1552	○ 862-1652	500	⊕-N-L1-L2	● 862-1504	○ 862-1604	200
			N-L1	● 862-2552	○ 862-2652	500	N-⊕-L1-L2	● 862-2504	○ 862-2604	200
	with ground contact						N-⊕-L1-L2	● 862-8504	○ 862-8604	200
			⊕-N-L1-L2	● 862-9504	○ 862-9604	200				
For fastening via self-tapping screw (2.9 mm Ø) from below,										
	without ground contact		without	● 862-562	○ 862-662	500	without	● 862-534	○ 862-634	200
			L1-N	● 862-1562	○ 862-1662	500	⊕-N-L1-L2	● 862-1534	○ 862-1634	200
			N-L1	● 862-2562	○ 862-2662	500	N-⊕-L1-L2	● 862-2534	○ 862-2634	200
	with ground contact						N-⊕-L1-L2	● 862-8534	○ 862-8634	200
			⊕-N-L1-L2	● 862-9534	○ 862-9634	200				
1 snap-in foot per pole,										
	without ground contact		without	● 862-532	○ 862-632	500	without	● 862-594	○ 862-694	200
			L1-N	● 862-1532	○ 862-1632	500	⊕-N-L1-L2	● 862-1594	○ 862-1694	200
			N-L1	● 862-2532	○ 862-2632	500	N-⊕-L1-L2	● 862-2594	○ 862-2694	200
	with ground contact						N-⊕-L1-L2	● 862-8594	○ 862-8694	200
			⊕-N-L1-L2	● 862-9594	○ 862-9694	200				
For fastening screw and nut (3 mm Ø) or self-tapping screw (2.9 mm Ø) from top,										
	without ground contact		without	● 862-503	○ 862-603	250	without	● 862-505	○ 862-605	200
			⊕-N-L1	● 862-1503	○ 862-1603	250	⊕-N-L1-L2-L3	● 862-1505	○ 862-1605	200
			N-⊕-L1	● 862-2503	○ 862-2603	250	N-⊕-L1-L2-L3	● 862-2505	○ 862-2605	200
	with ground contact						N-⊕-L1-L2-L3	● 862-8505	○ 862-8605	200
			⊕-N-L1	● 862-9503	○ 862-9603	250	⊕-N-L1-L2-L3	● 862-9505	○ 862-9605	200
1 snap-in foot per pole,										
	without ground contact		without	● 862-533	○ 862-633	250	without	● 862-525	○ 862-625	200
			⊕-N-L1	● 862-1533	○ 862-1633	250	⊕-N-L1-L2-L3	● 862-1525	○ 862-1625	200
			N-⊕-L1	● 862-2533	○ 862-2633	250	N-⊕-L1-L2-L3	● 862-2525	○ 862-2625	200
	with ground contact						N-⊕-L1-L2-L3	● 862-8525	○ 862-8625	200
			⊕-N-L1	● 862-9533	○ 862-9633	250	⊕-N-L1-L2-L3	● 862-9525	○ 862-9625	200
Snap-in feet at pos. 1+3										
	without ground contact		without	● 862-593	○ 862-693	250	without	● 862-515	○ 862-615	200
			⊕-N-L1	● 862-1593	○ 862-1693	250	⊕-N-L1-L2-L3	● 862-1515	○ 862-1615	200
			N-⊕-L1	● 862-2593	○ 862-2693	250	N-⊕-L1-L2-L3	● 862-2515	○ 862-2615	200
	with ground contact						N-⊕-L1-L2-L3	● 862-8515	○ 862-8615	200
			⊕-N-L1	● 862-9593	○ 862-9693	250	⊕-N-L1-L2-L3	● 862-9515	○ 862-9615	200

Accessories, 862 Series

Comb-style jumper bar , simply push into the conductor entry I _N 32 A 862-482 5	Test plug , with 500 mm cable ● 2 mm Ø 210-136 50 ● 2.3 mm Ø 210-137 50	Marking strip , plain, 7.5 mm wide, 50 m roll ○ 709-178 1
---	--	--

② Approvals are available online at: www.wago.com.

Transformer Terminal Blocks with Screw Clamp Connection, 200 / 201 / 202 Series – Description and Installation –

Solder connection

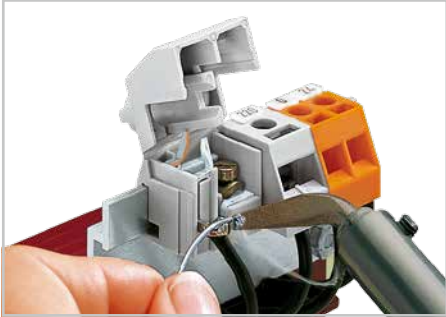

Soldering winding ends.

Snapping cover



Snapping cover onto 202 Series terminal block.

Fuse



Touch-proof insertion/removal of fuse carrier

Conductor termination



Large conductor entries and clear identification of the connection points

Finger guard



All WAGO transformer terminal blocks are touch-proof per VBG 4.

Beschriften

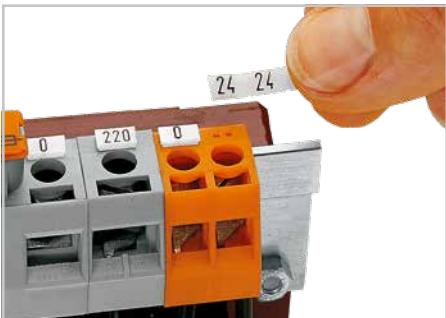

Terminal identification with marker tags



- Simple snap-on mounting on flat rails
- Easy conductor termination via self-lifting clamping ring
- Large cross-section range up to 10 mm² (57 A)

Transformer Terminal Blocks with CAGE CLAMP® Connection, 711 Series CAGE CLAMP®

– Description and Handling –

Installation*

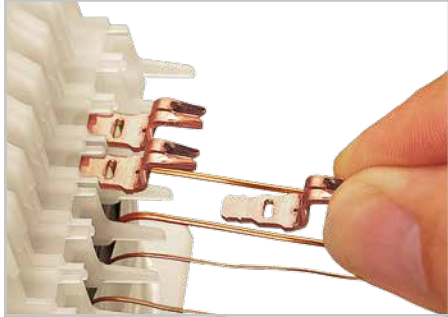

Pre-assembly of coil contacts:
Inserting a contact into the coil bobbin.

Insulation Displacement Connection (IDC)



Final assembly of coil contacts:

- Pressing in contacts via tool ①
- Final position ②

Solder connection

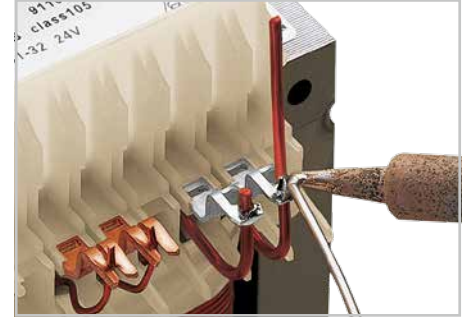

Combining IDC and solder connection - coil contacts with solder connection for larger cross-sections or connection of several coil wires (center tap)

*Detailed installation notes upon request

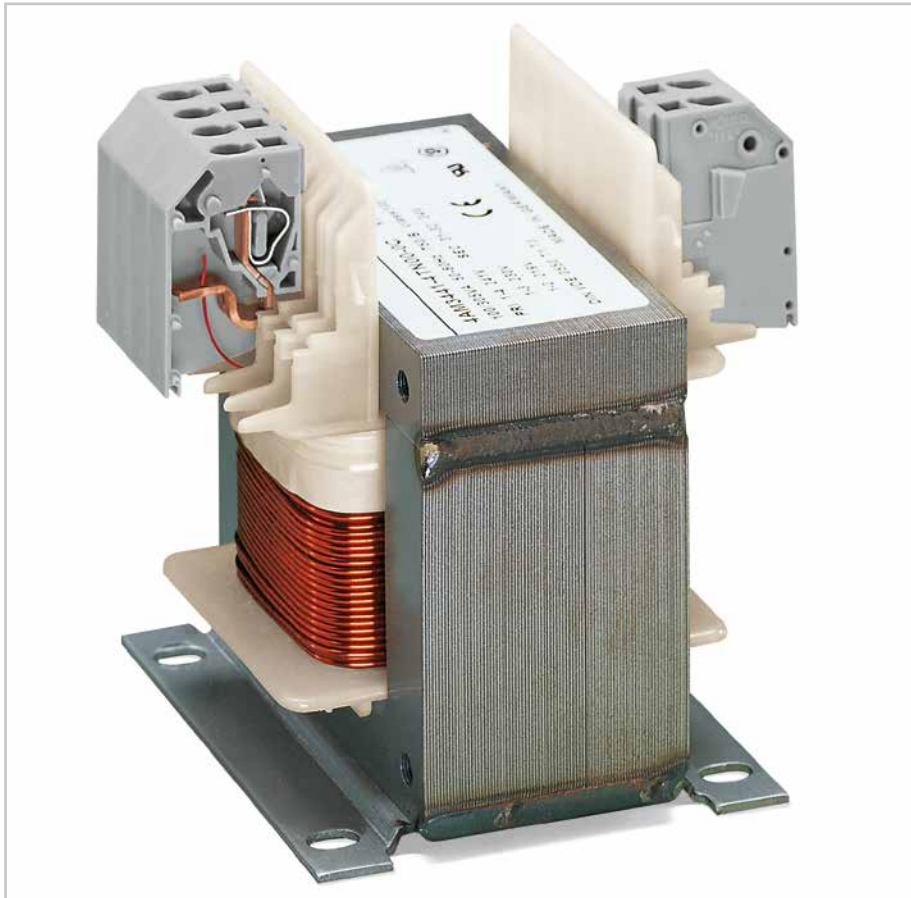

- Fast wiring through direct contact with the varnished coil wires
- Up to 90 % faster - no soldering required for small conductor sizes
- Modular block assembly means that only one snap-on process is required for the terminal blocks

Mounting

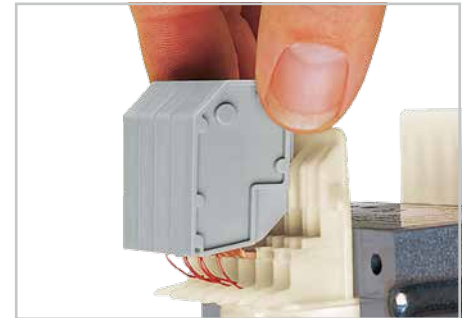

After connecting the coil wires (IDC: only one wire per contact) - looping possible), snap terminal blocks and end plate together before mounting the terminal block assembly onto the coil bobbin.

Final position

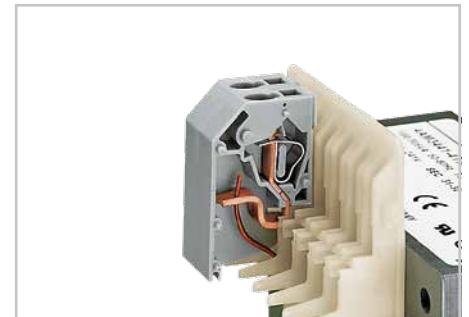

Terminal block in final position (primary side)

CAGE CLAMP® connection 0.08 ... 4 mm²

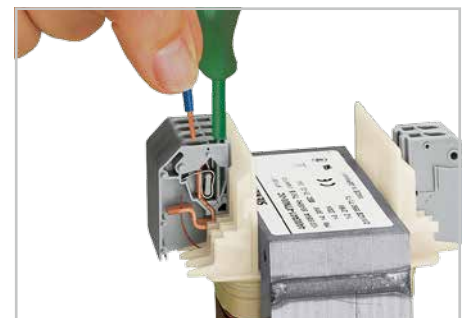

Conductor termination (secondary side)

Field-Wiring Terminal Blocks for Lighting and Equipment - Description and Handling -

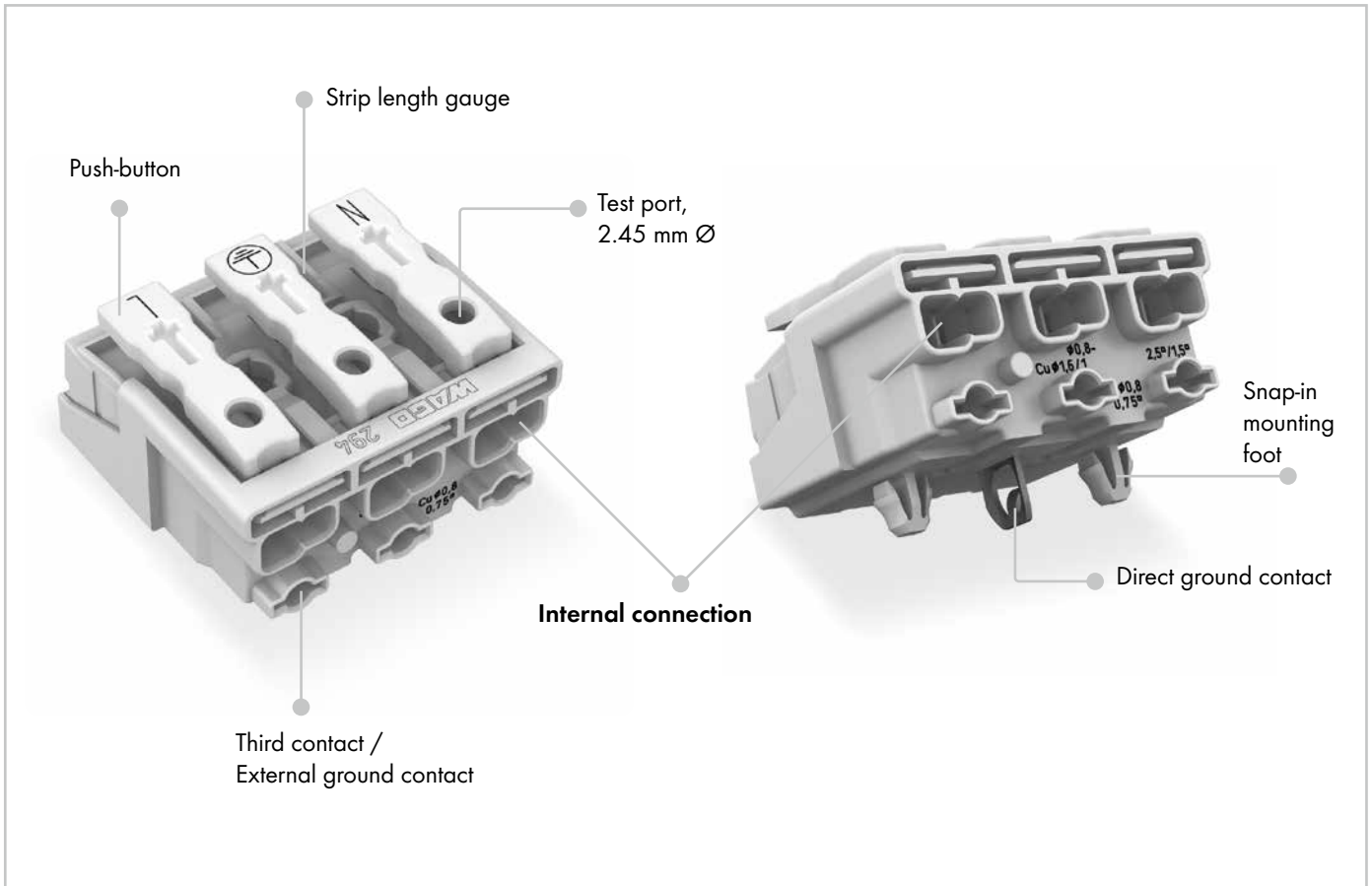

Application example

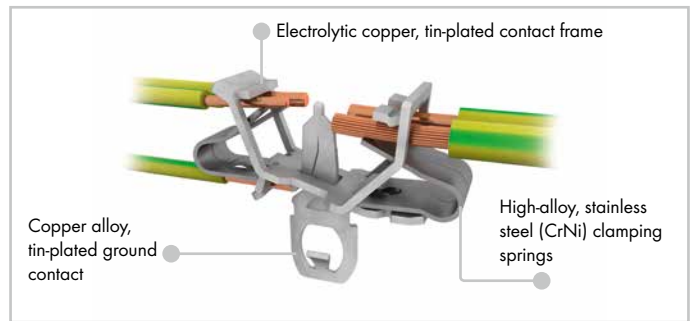

Contact technology



Integrated strip length gauge



Conductor removal: Slide disconnection tool beneath the conductor and pull conductor out.

For information on Push-in CAGE CLAMP® connection, see page 14.

For information on PUSH WIRE® connection, see page 15.

Lighting Terminal Blocks

294 Series

PUSH WIRE®

PUSH-IN CAGE CLAMP®

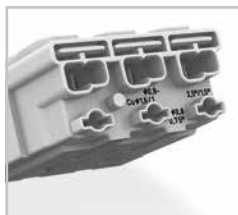

Pole No.	Marking	Item No.		Item No.		Item No.		Item No.		Item No.	
		Without Snap-In	With Mounting Feet	Without Snap-In	With Mounting Feet	Without Snap-In	With Mounting Feet	Without Snap-In	With Mounting Feet	Without Snap-In	With Mounting Feet
2	without	294-4002	294-5002	-	-	-	-	-	-	-	-
	N L	294-4012	294-5012	-	-	-	-	-	-	-	-
	N' L'	294-4022	294-5022	-	-	-	-	-	-	-	-
	DA- DA+	294-4032	294-5032	-	-	-	-	-	-	-	-
	- +	294-4072	294-5072	-	-	-	-	-	-	-	-
	1 N	294-4052	294-5052	-	-	-	-	-	-	-	-
	2 1	294-4042	294-5042	-	-	-	-	-	-	-	-

3	without	294-4003	294-5003	-	-	-	-	-	-	-	-
	N ⊕ L	294-4013	294-5013	-	294-5113	294-4413	294-5413	294-4213	294-5213	294-4313	294-5313
	N' ⊕ L'	294-4023	294-5023	-	294-5123	294-4423	294-5423	294-4223	294-5223	294-4323	294-5323
	1 ⊕ N	294-4053	294-5053	-	294-5153	294-4453	294-5453	294-4253	294-5253	294-4353	-
	3 2 1	294-4043	294-5043	-	-	-	-	-	-	-	-

4	without	294-4004	294-5004	-	-	-	-	-	-	-	-
	1/L' 2/L ⊕ N	294-4024	294-5024	-	294-5124	294-4424	294-5424	294-4224	294-5224	294-4324	294-5324
	1 2 ⊕ N	294-4014	294-5014	-	294-5114	294-4414	294-5414	294-4214	294-5214	294-4314	294-5314
	4 3 2 1	294-4044	294-5044	-	-	-	-	-	-	-	-

5	without	294-4005	294-5005	-	-	-	-	-	-	-	-
	L3 L2 L1 ⊕ N	294-4015	294-5015	-	-	294-4415	294-5415	294-4215	294-5215	294-4315	294-5315
	L' N' L ⊕ N	294-4025	294-5025	-	-	294-4425	294-5425	294-4225	294-5225	294-4325	294-5325
	DA+ DA- L ⊕ N	294-4035	294-5035	-	-	294-4435	294-5435	294-4235	294-5235	294-4335	294-5335
	DA- N ⊕ L DA+	294-4075	294-5075	-	294-5175	294-4475	294-5475	294-4275	294-5275	294-4375	294-5375
	3 N ⊕ 1 2	294-4055	294-5055	-	294-5155	294-4455	294-5455	294-4255	294-5255	294-4355	294-5355
5 4 3 2 1	294-4045	294-5045	-	-	-	-	-	-	-	-	

6	without	294-4006	-	-	-	-	-	-	-	-	-
---	---------	----------	---	---	---	---	---	---	---	---	---

7	without	294-4007	-	-	-	-	-	-	-	-	-
---	---------	----------	---	---	---	---	---	---	---	---	---

Accessories



Disconnection tool,
for removing conductors from PUSH WIRE® connections
206-294 1



Lighting Terminal Blocks - Description and Handling -

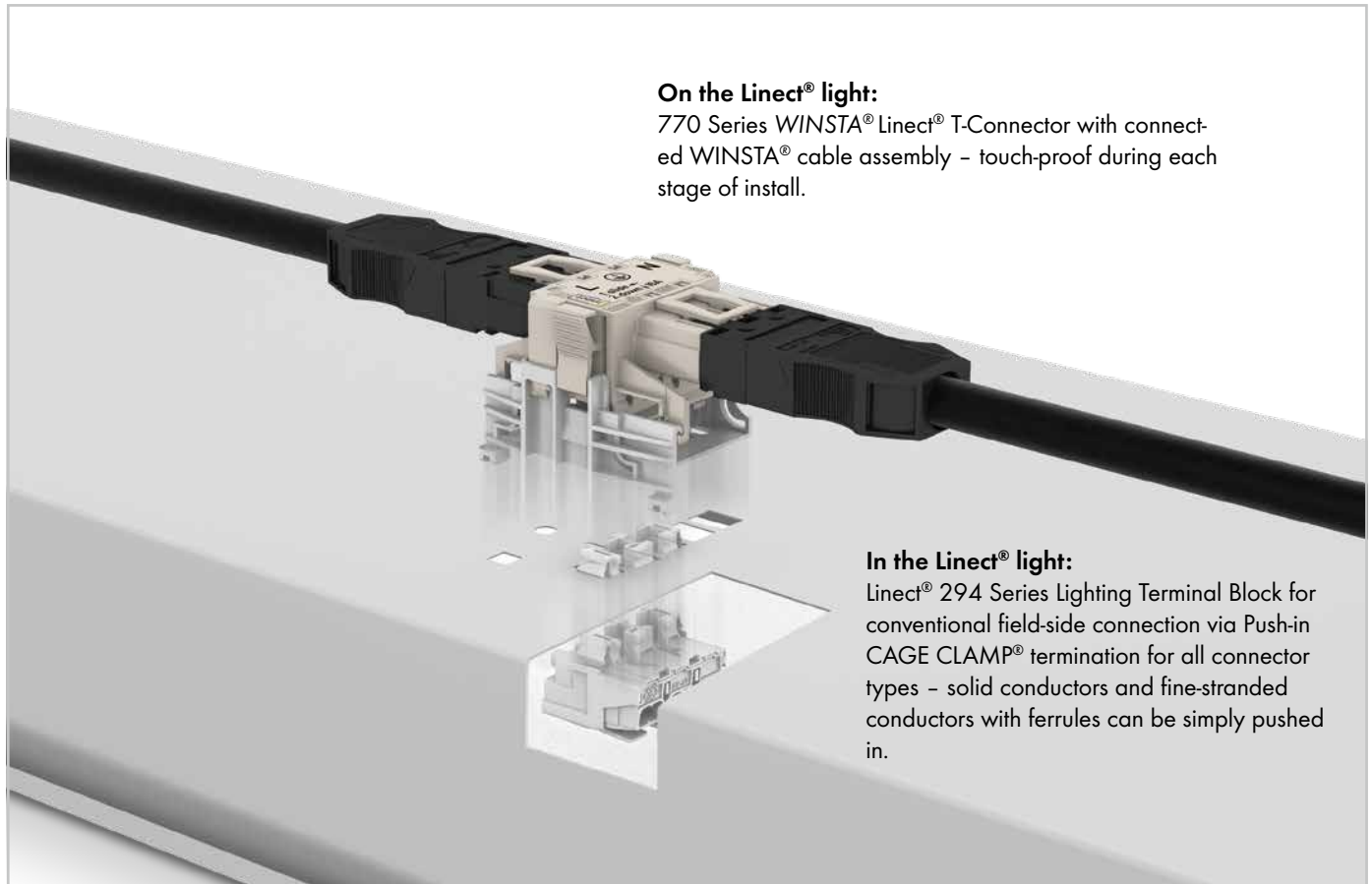

On the Linect® light:
770 Series WINSTA® Linect® T-Connector with connected WINSTA® cable assembly – touch-proof during each stage of install.

In the Linect® light:
Linect® 294 Series Lighting Terminal Block for conventional field-side connection via Push-in CAGE CLAMP® termination for all connector types – solid conductors and fine-stranded conductors with ferrules can be simply pushed in.

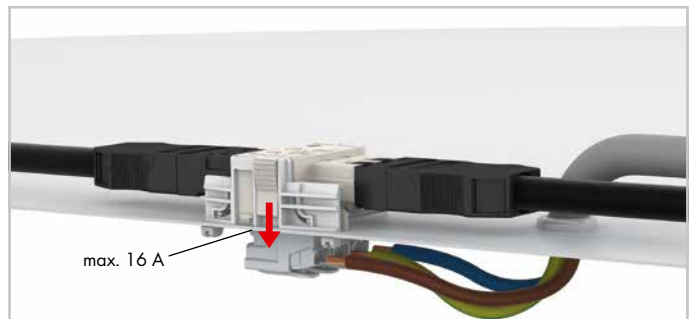
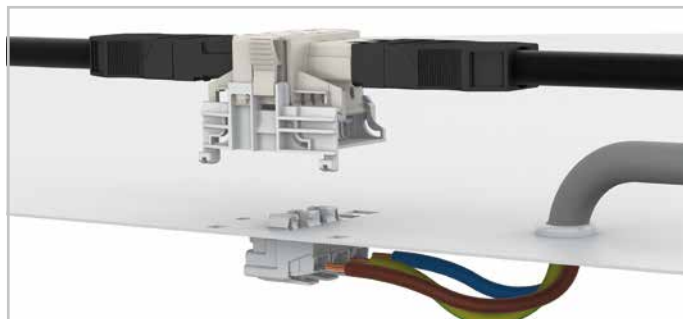

The WAGO 294 Series Lighting Terminal Blocks allow worldwide connection of luminaires via WINSTA® Pluggable Connectors or conventional wiring.

WAGO Linect® Lighting Terminal Blocks are ideal for connecting additional consumers that were not originally planned (e.g., spots). The maximum current between WINSTA® Linect® T-Connector and Lighting Terminal Block is 16 A.



Position the T-connector within the two square recesses.



Move the T-connector toward the square cutouts until it is locked in position.



Push connector down until fully engaged.

For information on Push-in CAGE CLAMP® connection, see page 14.

For information on PUSH WIRE® connection, see page 15.

Lighting Terminal Blocks Linect® 294 Series

PUSH WIRE®

PUSH-IN CAGE CLAMP®



2

Pole No.	Marking	Item No.	Item No.	Item No.	Item No.	Item No.
2	N' L'	294-8022	- - -	- - -	- - -	- - -
3	N ⊕ L (mains)	294-8013	294-8113	294-8413	294-8213	294-8313
4	1/L' 2/L ⊕ N	294-8024	294-8124	294-8424	294-8224	294-8324
5	DA+ DA- L ⊕ N	294-8035	294-8135	294-8435	294-8235	294-8335
	L' N' L ⊕ N	294-8025	294-8125	294-8425	294-8225	294-8325
	L3 L2 L1 ⊕ N	294-8015	294-8115	294-8415	294-8215	294-8315

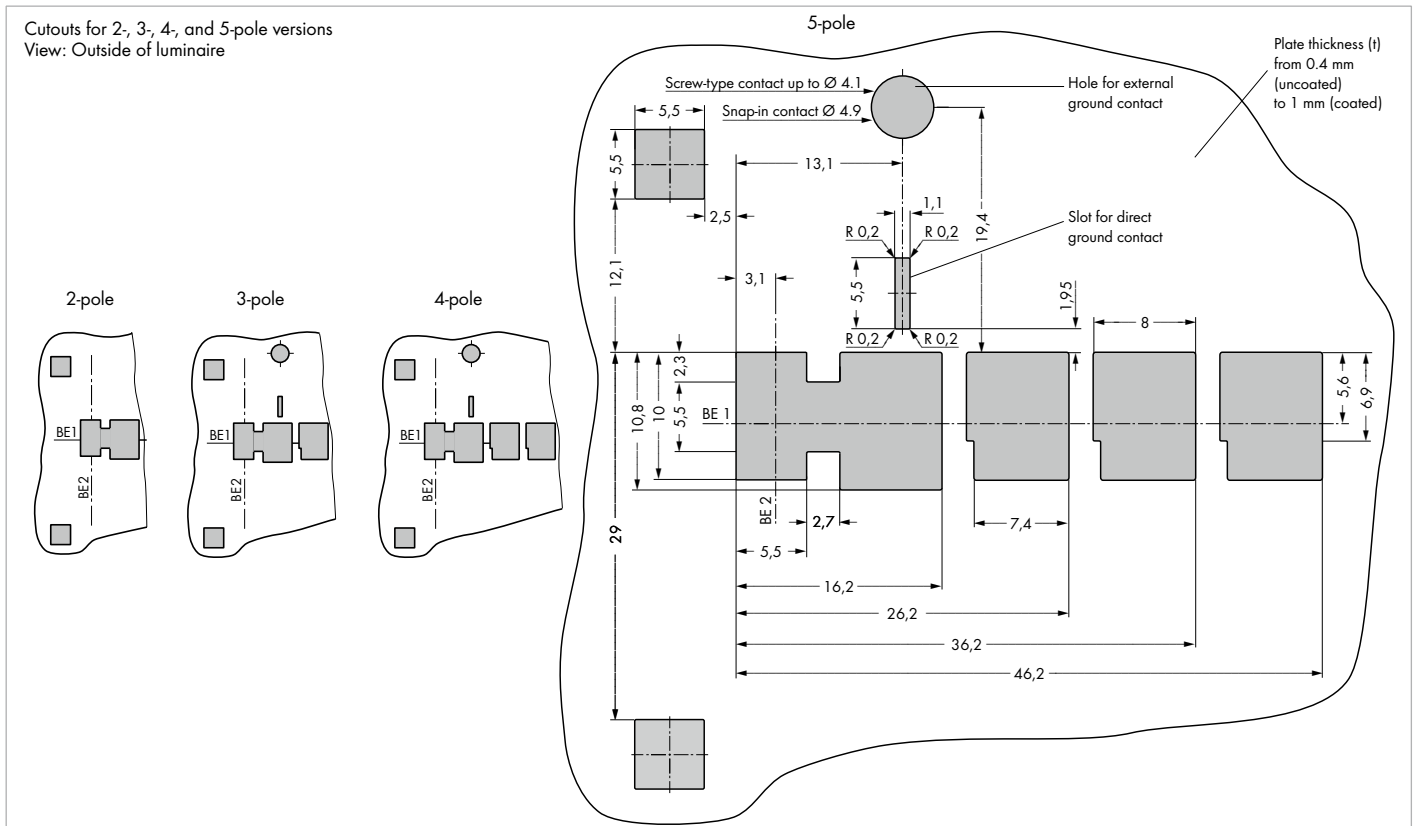

Approvals are available online at: www.wago.com.

MICRO PUSH WIRE® Connectors for Junction Boxes – Description and Handling –

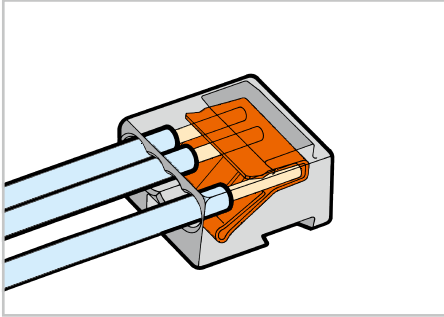

Strip length

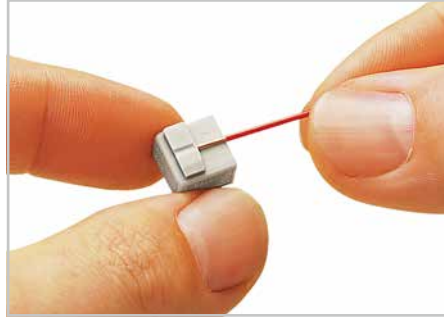

Strip solid conductors to 5 ... 6 mm.

Connector strips



Assembling modular connectors into connector strips.

PUSH WIRE® connection

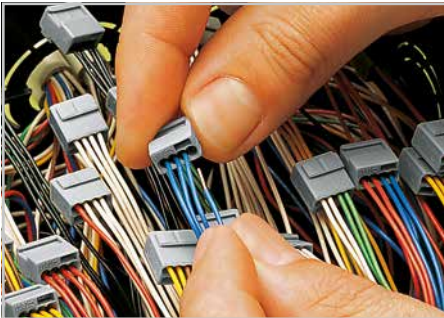

Termination: Insert stripped conductor until it hits backstop.

PUSH WIRE® connection

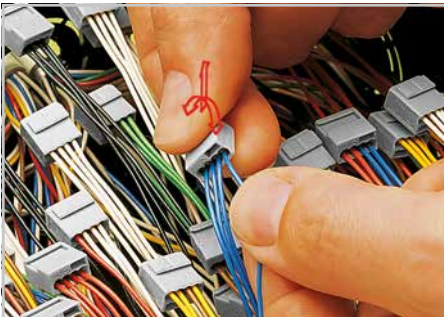

Removal: Hold conductor to be removed and twist alternately left and right while pulling the connector.

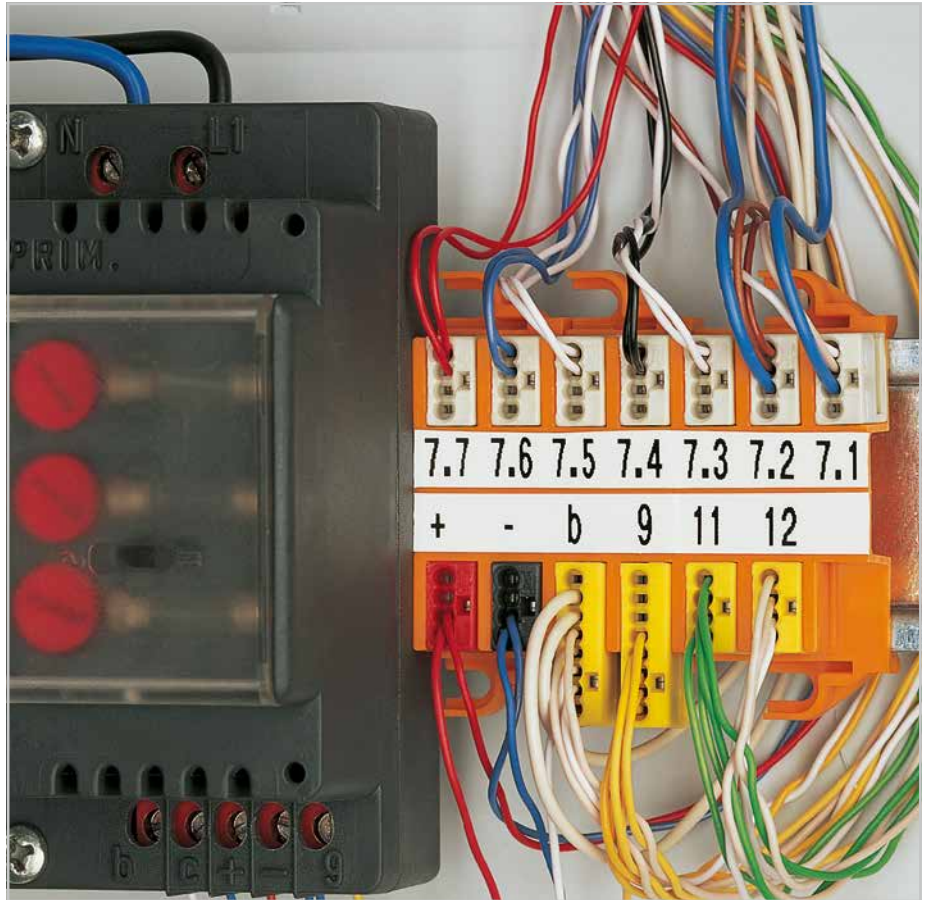

Testing



Testing

Applications



Switch (specialty connectors with solder pin termination)

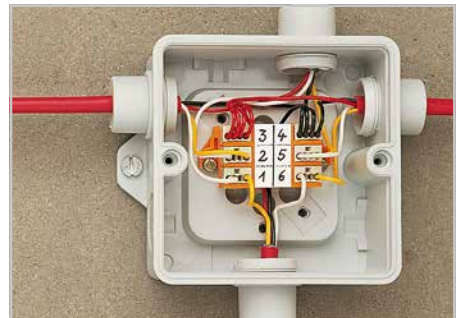

Terminal box for burglar alarm

MICRO PUSH WIRE® Connectors for Junction Boxes, Mounting Carriers

243 Series

0.6 ... 0.8 mm Ø "s"*** 100 V/1.5 kV/2 I _N 6 A	22 ... 20 AWG "s"*** 150 V, 7 A 150 V, 7 A	0.6 ... 0.8 mm Ø "s"*** 100 V/1.5 kV/2 I _N 6 A	22 ... 20 AWG "s"*** 150 V, 7 A 150 V, 7 A	Mounting carriers for MICRO PUSH WIRE® connectors for junction boxes
5 ... 6 mm / 0.22 in.	5 ... 6 mm / 0.22 in.	5 ... 6 mm / 0.22 in.	5 ... 6 mm / 0.22 in.	
Approvals	Approvals	Approvals	Approvals	

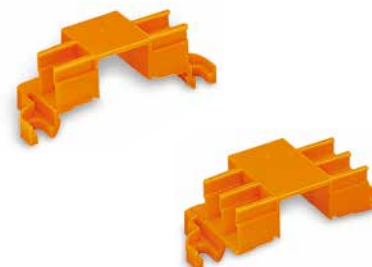

Color	Item No.	Pack. Unit	Color	Item No.	Pack. Unit	Description	Item No.	Pack. Unit
MICRO PUSH WIRE® connector for junction boxes, 4-cond. connectors			MICRO PUSH WIRE® connector for junction boxes, 8-cond. connectors			Mounting carrier,		
● dark gray	243-204	1000 (10x100)	● dark gray	243-208	500 (10x50)	● for 4 connectors	243-112	50 (5x10)
● red	243-804	1000 (10x100)	● red	243-808	500 (10x50)	● for 6 connectors	243-113	50 (5x10)
○ light gray	243-304	1000 (10x100)	○ light gray	243-308	500 (10x50)	Marking strip,		
● yellow	243-504	1000 (10x100)	● yellow	243-508	500 (10x50)	7 mm high, 6 strips per card		
						○ plain	243-110	1

0.4 ... 0.5 mm Ø "s"*** 100 V/1.5 kV/2 I _N 6 A	26 ... 24 AWG "s"***
5 ... 6 mm / 0.22 in.	
Approvals	



Color	Item No.	Pack. Unit
MICRO PUSH WIRE® connector for junction boxes, 4-cond. connectors		
○ transparent	243-144	1000 (10x100)

Dimensions

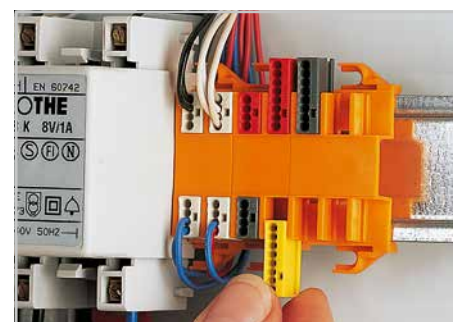
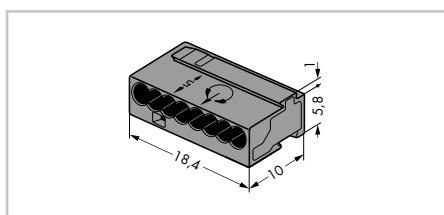
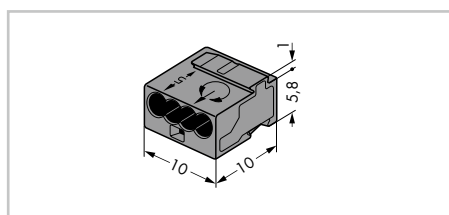

Inserting a connector into the mounting carrier.

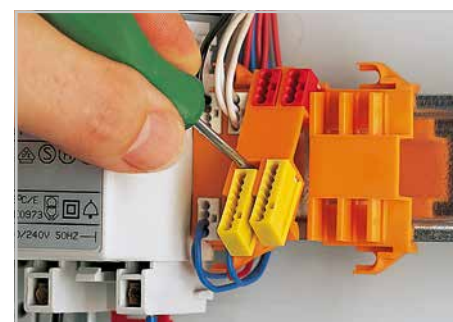

Removing a mounting carrier from the DIN-rail.

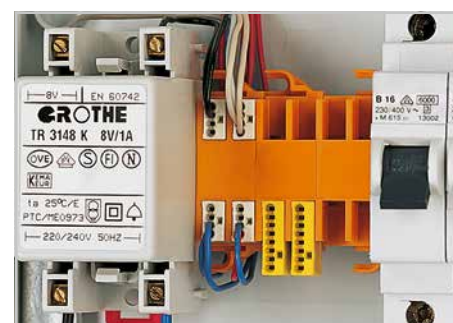

DIN-35 rail-mount application (residential door bell)

Approvals are available online at: www.wago.com. For technical explanations and abbreviations, see technical section.
*When using conductors of exclusively the same diameter, 0.5 mm (24 AWG) or 1.0 mm (18 AWG) diameters are also possible.

PUSH WIRE® Connectors for Junction Boxes – Description and Handling –

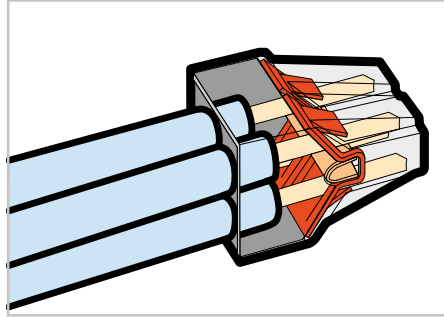
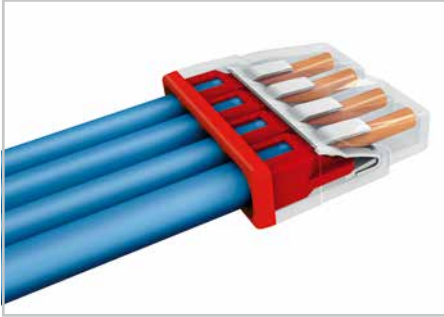

Strip length



Strip solid conductor to the appropriate length (see marking).

Testing



Testing

PUSH WIRE® connection



Insert stripped solid conductor until it hits backstop.

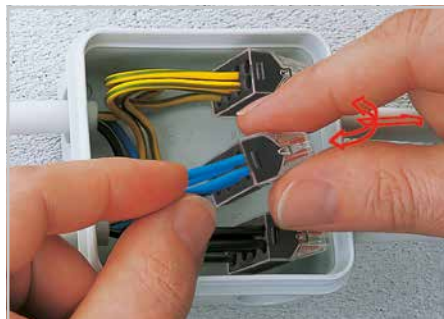

Removal: Hold conductor to be removed and twist alternately left and right while pulling the connector.

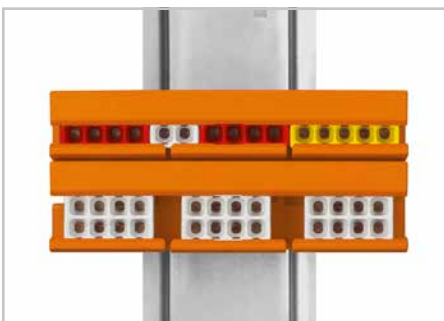

The mounting carrier is suitable for both connector profiles.



Secured in position – on a DIN-35 rail (773 Series Mounting Carrier)

COMPACT PUSH WIRE® Connectors for Junction Boxes 2273 Series

0.5 ... 2.5 mm² "s" 18 ... 14 AWG "s"
450 V/4 kV/2***
I_N 24 A

11 mm / 0.43 in.

1 Approvals



Color	Item No.	Pack. Unit
COMPACT PUSH WIRE® connector for junction boxes, transparent housing		
○ 2 conductors	2273-202	1000 (10x100)
● 3 conductors	2273-203	1000 (10x100)
● 4 conductors	2273-204	1000 (10x100)

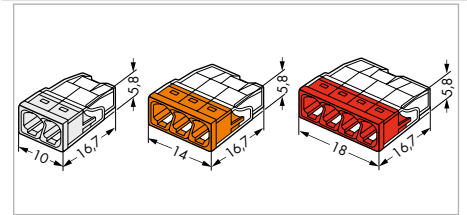

0.5 ... 2.5 mm² "s" 18 ... 14 AWG "s"
450 V/4 kV/2***
I_N 24 A

11 mm / 0.43 in.

1 Approvals



Color	Item No.	Pack. Unit
COMPACT PUSH WIRE® connector for junction boxes, transparent housing		
● 5 conductors	2273-205	1000 (10x100)
○ 8 conductors	2273-208	500 (10x50)

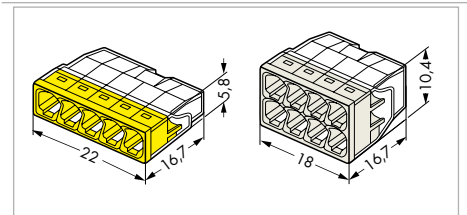

For information on PUSH WIRE® connection, see page 15.

1 Approvals are available online at: www.wago.com.

***In grounded power lines

For technical explanations and abbreviations, see technical section.

Lighting and "Service" Connectors

224 / 873 Series

PUSH WIRE®

CAGE CLAMP®

Strip length

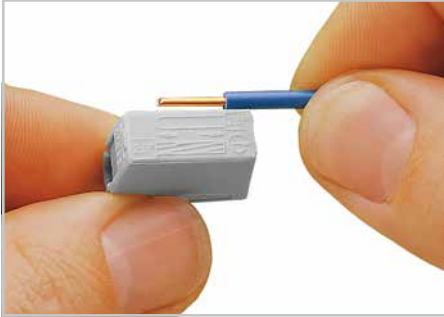

Strip conductor to 9 ... 11 mm.

Installation side		2-conductor plug		1-conductor socket	
1 ... 2.5 mm ² "s"	14 ... 12 AWG	18 ... 12 AWG "s"	18 AWG "s"		
2 x 1.0 ... 2.5 mm ² "s"	16 ... 14 AWG	16 ... 12 AWG "st"	600 V, 6 A ^(UL)		
Lighting side		11 ... 13 mm / 0.47 in. 9 ... 11 mm / 0.39 in.			
0.5 ... 2.5 mm ² "s+st"	20 ... 16 AWG				
400 V/4 kV/2*, I _N 24 A	300 V, 20 A ^(UL)				

Approvals

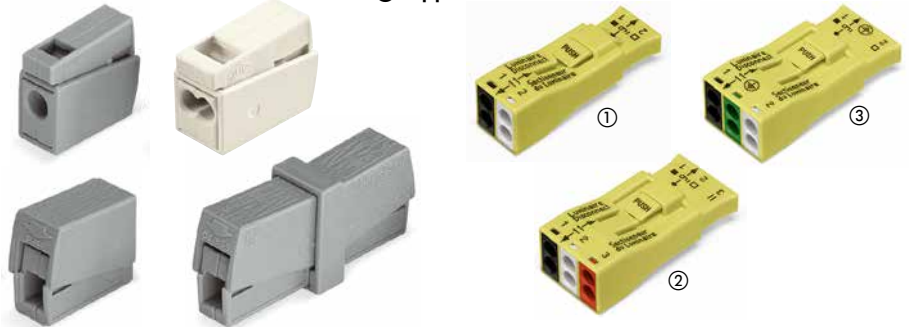

Testing



Voltage testing via separate test ports.

Color	Item No.	Pack. Unit	Type/Pole No.	Item No.	Pack. Unit
Lighting connector, standard version for continuous operating temperature of 105 °C			Luminaire disconnect connector (U.S. Version), type ①		
● gray	224-101	1000	2	873-902	40
Version for increased continuous operating temperature of 120 °C			type ②		
● black	224-104	100	3	873-903	20
2-conductor lighting connector, standard version for continuous operating temperature of 105 °C			Luminaire disconnect connector (U.S. Version), type ③, preceding ground contact in center position		
○ white	224-112	1000	3	873-953	500
Version for increased continuous operating temperature of 120 °C					
● black	224-114	100			
"Service" connector					
● gray	224-201	50			

Conductor termination

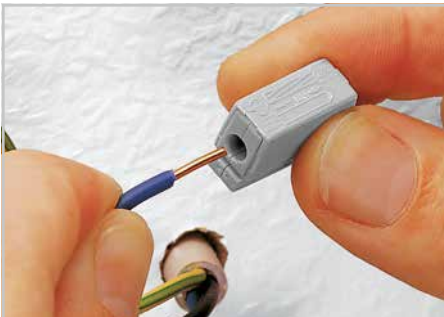

Installation side:
Insert stripped solid conductor into circular entry and push until it hits the backstop.



Lighting side:
Press button fully, insert stripped conductor into square entry and release.

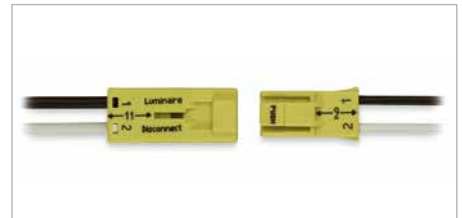
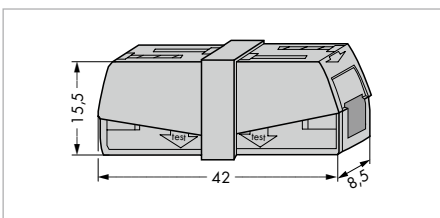
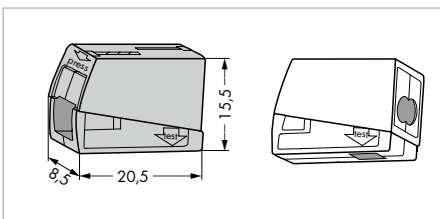
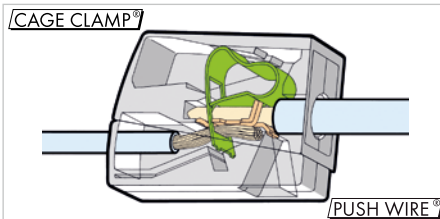

<p>18-12 AWG CU, SOL, UL/CSA 0.75-4 mm²</p>	<p>18 AWG CU, SOL, UL/CSA 0.75 mm²</p>
<p>16-12 AWG (S19 or) CU, UL 14-12 AWG (S19 or) CU, CSA 1.5-4 mm² One-time use only. Do not reuse. N'utiliser qu'une seule fois.</p>	<p>14-12 AWG (S19 or) CU, CSA 1.5-4 mm² One-time use only. Do not reuse. N'utiliser qu'une seule fois.</p>
<p>0.45 inch / 11 - 13 mm</p>	<p>0.35 inch / 9 - 11 mm</p>
<p>Correct method of solid wire removal Hold wire to be removed in one hand, the connector in the other - twist slightly while pulling the connector. Démonstration correcte du conducteur rigide Tenir d'une main le conducteur à déconnecter et de l'autre main le connecteur - Opérer une légère torsion du conducteur tout en tirant sur le connecteur.</p>	

Approvals are available online at: www.wago.com.

Lever-Actuated Splicing Connectors for All Conductor Types

CAGE CLAMP®

221 / 222 Series

Strip length

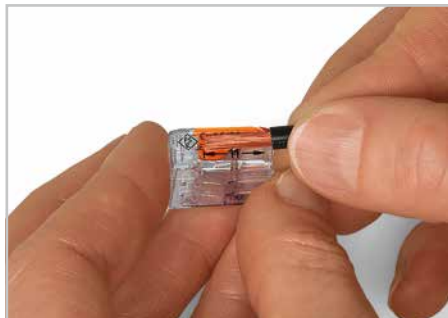

Strip conductor to 11 mm (221 Series).
Strip conductor to 9 ... 10 mm (222 Series).



Lighting distribution in ceiling canopy

Conductor termination



Conductor termination: Open the clamping unit using the lever and insert conductor. Then, lower the lever to close the clamp.

0.2 ... 4 mm² "s+st"
0.14 ... 4 mm² "f-st"
450 V/4 kV/2*
I_N 32 A

24 ... 12 AWG

11 mm / 0.43 in.
Approvals

0.08 ... 2.5 mm² "s+f-st"
0.08 ... 4 mm² "f-st"
400 V/4 kV/2*
I_N 32 A

28 ... 14 AWG "s+f-st"
28 ... 12 AWG "f-st"
600 V, 20 A ®

9 ... 10 mm / 0.37 in.
Approvals



Color	Item No.	Pack. Unit	Color	Item No.	Pack. Unit
COMPACT splicing connector for all conductor types, with levers, max. continuous operating temperature: 105 °C			CLASSIC splicing connector for all conductor types, with levers, max. continuous operating temperature: 85 °C		
2-conductor connector <input type="radio"/> transparent			2-conductor connector <input type="radio"/> gray		
	221-412	1000(10x100)		222-412	500(10x50)
3-conductor connector <input type="radio"/> transparent			3-conductor connector <input type="radio"/> gray		
	221-413	500(10x50)		222-413	500(10x50)
5-conductor connector <input type="radio"/> transparent			5-conductor connector <input type="radio"/> gray		
	221-415	400(10x40)		222-415	400(10x40)
Mounting carrier, for 2-, 3- and 5-conductor splicing connectors <input type="radio"/>			Mounting carrier, for 2-, 3- and 5-conductor splicing connectors <input type="radio"/>		
	221-500	50(5x10)		222-500	50(5x10)
Strain relief plate, for mounting carrier <input type="radio"/>			Strain relief plate, for mounting carrier <input type="radio"/>		
	222-505	50(5x10)		222-505	50(5x10)
Angled DIN-rail adapter, for DIN-35 rail mounting <input type="radio"/>			Angled DIN-rail adapter, for DIN-35 rail mounting <input type="radio"/>		
	222-510	50(5x10)		222-510	50(5x10)
Self-adhesive marking strips, plain 48 strips per card <input type="radio"/>			Self-adhesive marking strips, plain 48 strips per card <input type="radio"/>		
	210-334	1		210-334	1



Vertical mounting with strain relief plate on DIN-35 rail; labeling clamping units via marking strips for 221/222 Series.

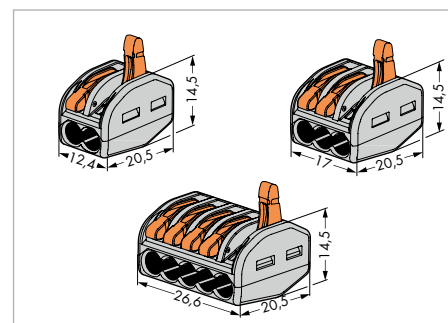
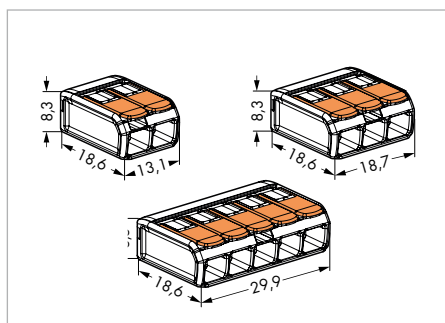

picoMAX® Pluggable Connectors - Description and Installation -

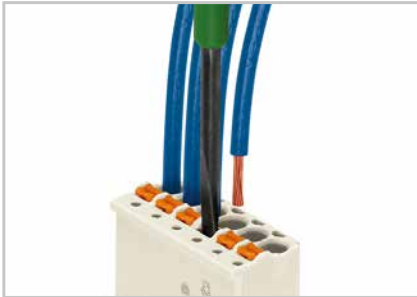

Inserting a fine-stranded conductor into an unmated female connector via push-button.

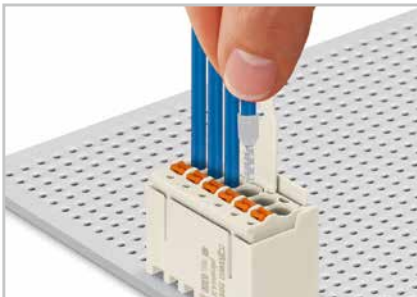

Inserting solid and ferruled conductors via push-in termination.

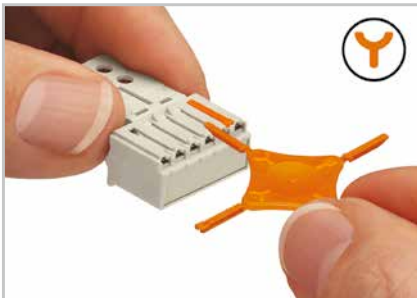

Coding a female connector (via 209x-1610 Coding Key Carrier and two keys for female connector, see symbol).

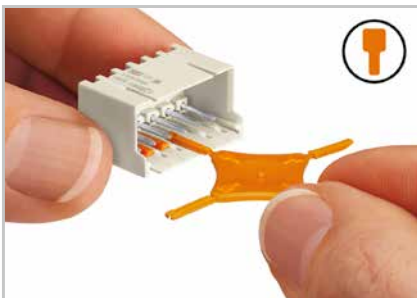

Coding a male header (via 209x-1610 Coding Key Carrier and two keys for male header, see symbol).

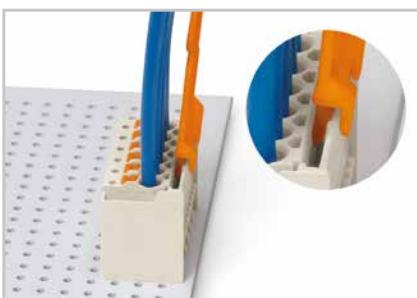

Disconnecting a female connector via unlocking tool. Plug unlocking tool into the male header's locking latch.

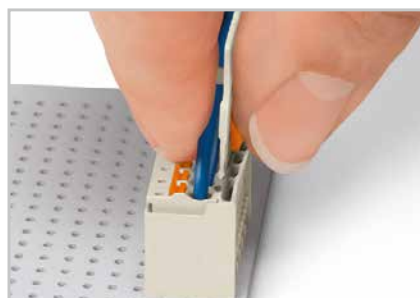
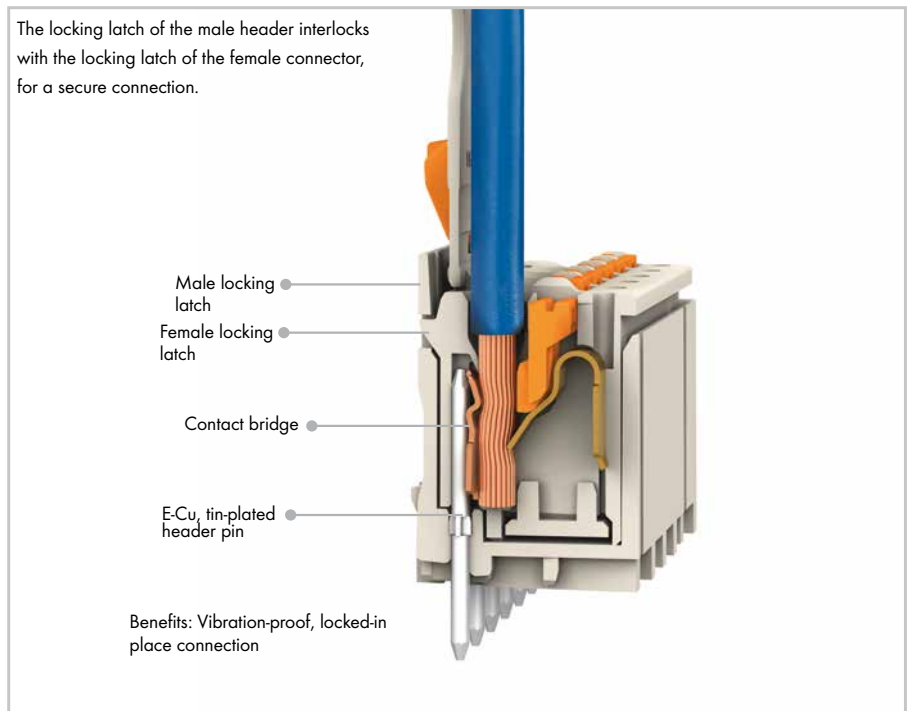
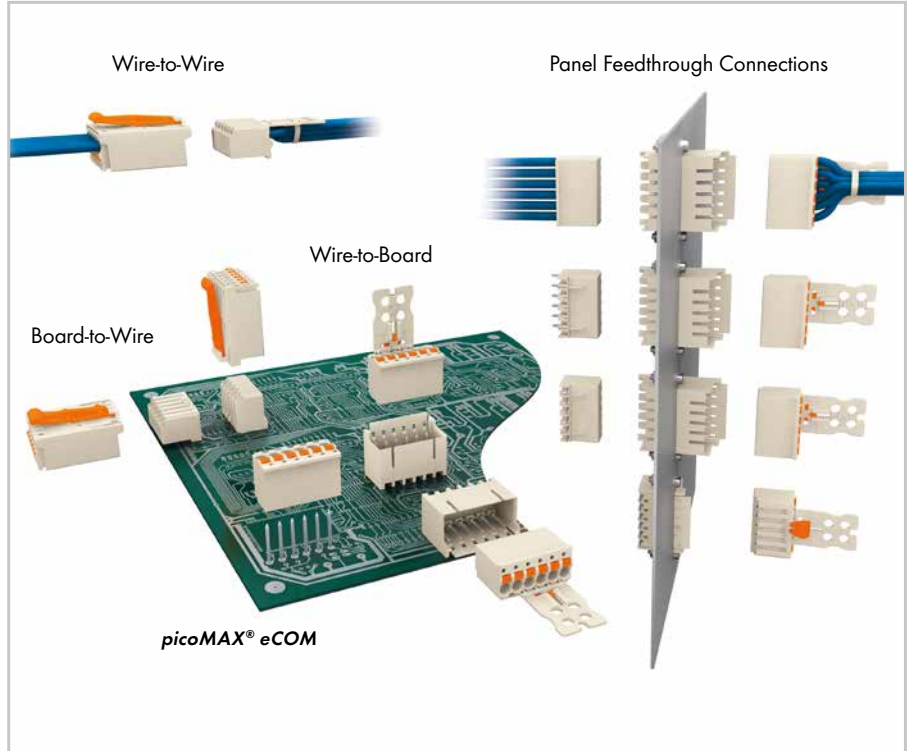

Push down sliding connector release (gripping plate) to open the locking latch.



Easy-to-identify PCB inputs and outputs

picoMAX® Pluggable Connectors

PUSH-IN CAGE CLAMP®

Combination Overview for Male and Female Connectors/Headers

Pin Spacing: 3.5 mm (0.138 in.); 5.0 mm (0.197 in.); 7.5 mm (0.295 in.)

Male Connectors/Headers

Item No.	Pack. Unit	Item No.	Pack. Unit	Item No.	Pack. Unit	Item No.	Pack. Unit
with straight solder pins, 2 ... 12 poles		with angled solder pins, 2 ... 12 poles		for conductor connection, 2 ... 5 poles		for panel feedthrough connections, 2 ... 8 poles	
				0.2 ... 2.5 mm² / 24 ... 12 AWG		Outside	Inside (unlocked)
2091-1402	200	2091-1422	200	2091-1522/002-000	200	2091-1632/024-000	100
2091-1412	100	2091-1432	100	2091-1528/002-000	50	2091-1638/002-000	50

Female Connectors/Headers	Description	Male Connector/Header 1		Male Connector/Header 2		Male Connector/Header 3		Male Connector/Header 4	
		Outside	Inside	Outside	Inside	Outside	Inside	Outside	Inside
for conductor connection, gripping plate and sliding connector release, 2 ... 12 poles		✓	✓	✓	✓	✓	✓	✓	✓
	0.2 ... 1.5 mm² / 24 ... 14 AWG								
2091-1102/002-000	100								
2091-1112/002-000	50								
for conductor connection, with gripping plate, 2 ... 12 poles		✓	✓	✓	✓	✓	✓	✓	✓
	0.2 ... 1.5 mm² / 24 ... 14 AWG								
2091-1102	200								
2091-1112	100								
for conductor connection, 2 ... 12 poles		✓	✓	✓	✓	✓	✓	✓	✓
	0.2 ... 1.5 mm² / 24 ... 14 AWG								
2091-1122	200								
2091-1132	100								
with straight solder pins, 2 ... 8 poles		✗	✗	✓	✓	✗	✓	✗	✓
	2091-1302	200							
2091-1308	100								
with angled solder pins, 2 ... 8 poles		✗	✗	✓	✓	✗	✓	✗	✓
	2091-1322	200							
2091-1328	100								

All data refers to 3.5 mm pin spacing.

Item numbers for:

3.5 mm pin spacing

2091-1xxx (160 V/10 A)

5 mm pin spacing

2092-1xxx (320 V/16 A)

7.5 mm pin spacing

2092-3xxx (630 V/16 A)



Disconnection: Open locking latches via unlocking tool (2092-1630).



This combination of male and female connectors/headers is allowed.



This combination of male and female connectors/headers is not allowed.

picoMAX® eCOM Pluggable Connectors PCB Terminal Blocks that Double as Pluggable Connectors

1. Place and solder the pluggable female headers as marked on the PCB.

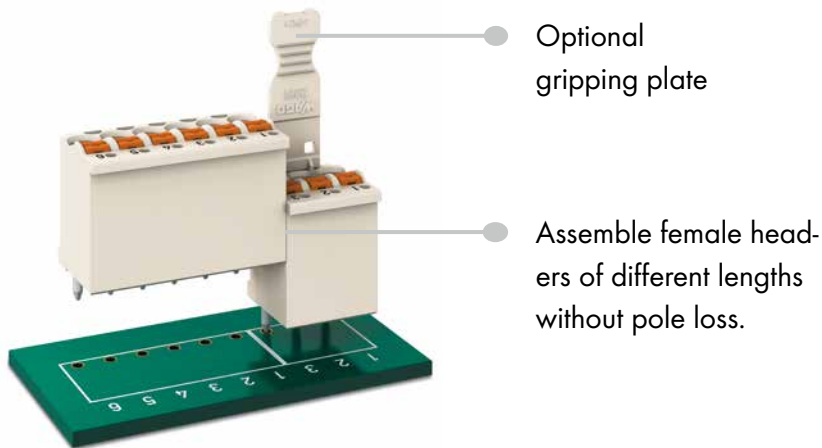

WAGO's *picoMAX*® eCOM Pluggable Female Headers are delivered with solder pins so they can be directly soldered to a PCB and then wired just as terminal blocks are.

Push-in CAGE CLAMP® allows solid, stranded and fine-stranded conductors to be terminated via push-buttons. Solid and feruled conductors are terminated by simply pushing them into unit. For simplified maintenance, the pluggable female headers can be removed without altering the wiring and then plugged onto the replacement PCB.

2. Wired female headers

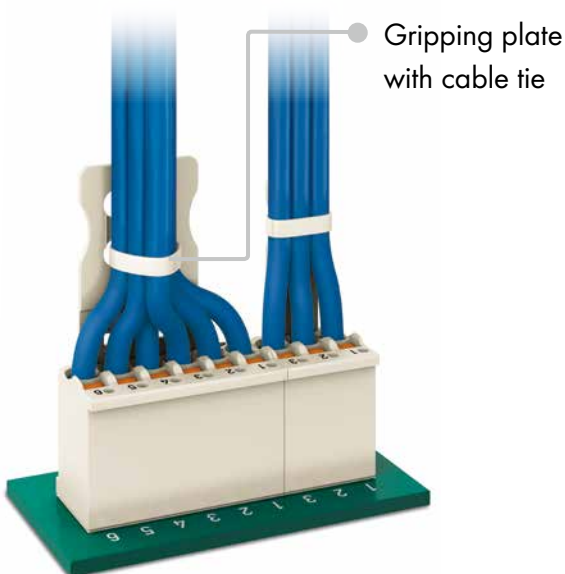

3. During maintenance

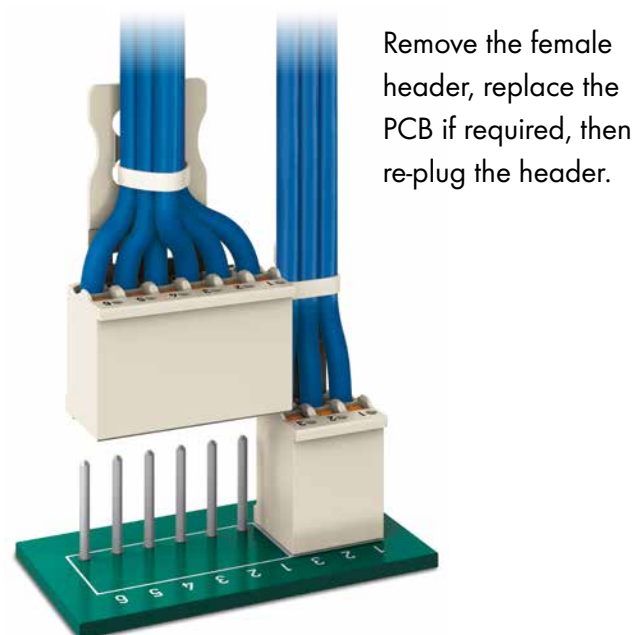







picoMAX® eCOM Pluggable Connectors

System Overview for Standard Female Headers

PUSH-IN CAGE CLAMP®

Pin Spacing: 3.5 mm (0.138 in.); 5.0 mm (0.197 in.); 7.5 mm (0.295 in.)

Female Connectors/Headers	Pin Spacing / Pole No.						Accessories	
	3.5 mm / 2 ... 12 poles		5 mm / 2 ... 12 poles		7.5 mm / 2 ... 5 poles		Item No.	Pack. Unit
	Item No.	Pack. Unit	Item No.	Pack. Unit	Item No.	Pack. Unit		
With straight solder pins, without gripping plate								Operating tool with a partially insulated shaft, type 1, (2.5 x 0.4) mm blade
	0.2 ... 1.5 mm ² / 24 ... 14 AWG		0.2 ... 2.5 mm ² / 24 ... 14 AWG		0.2 ... 2.5 mm ² / 24 ... 14 AWG			
	2091-1172 200 2091-1182 100		2092-1172 200 2092-1182 100		2092-3172 100 2092-3175 100			
With straight solder pins, with gripping plate								Unlocking tool for female connectors without gripping plate or sliding connector release
	0.2 ... 1.5 mm ² / 24 ... 14 AWG		0.2 ... 2.5 mm ² / 24 ... 14 AWG		0.2 ... 2.5 mm ² / 24 ... 14 AWG			
	2091-1152 100 2091-1162 50		2092-1152 100 2092-1162 50		2092-3152 100 2092-3155 100			
With angled solder pins, without gripping plate								Test pin , 1 mm Ø, with solder connection for test cable
	0.2 ... 1.5 mm ² / 24 ... 14 AWG		0.2 ... 2.5 mm ² / 24 ... 14 AWG		0.2 ... 2.5 mm ² / 24 ... 14 AWG			
	2091-1372 200 2091-1382 100		2092-1372 200 2092-1382 100		2092-3372 100 2092-3375 100			
With angled solder pins, with gripping plate								
	0.2 ... 1.5 mm ² / 24 ... 14 AWG		0.2 ... 2.5 mm ² / 24 ... 14 AWG		0.2 ... 2.5 mm ² / 24 ... 14 AWG			
	2091-1352 100 2091-1362 50		2092-1352 100 2092-1362 50		2092-3352 100 2092-3355 100			
Gripping plates for field assembly								
	2091-1600 100 2091-1603 100		2092-1600 100 2092-1603 100		2092-3600 100 2092-3603 100			
Gripping plates with sliding connector release for field assembly								
	2091-1600/002-000 100 2091-1603/002-000 100		2092-1600/002-000 100 2092-1603/002-000 100		2092-3600/002-000 100 2092-3603/002-000 100			

3

MCS – MULTI CONNECTION SYSTEM MICRO, MINI and MIDI

– Description and Installation, e.g., for CAGE CLAMP® Connection* –

CAGE CLAMP® connection

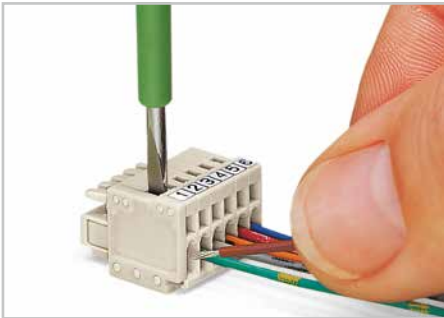

Inserting conductor via (2.5 x 0.4) mm screwdriver – CAGE CLAMP® actuation perpendicular to conductor entry.

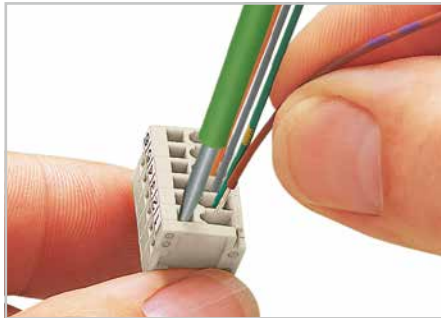

Inserting conductor via (2.5 x 0.4) mm screwdriver – CAGE CLAMP® actuation parallel to conductor entry.

Mismatching protection

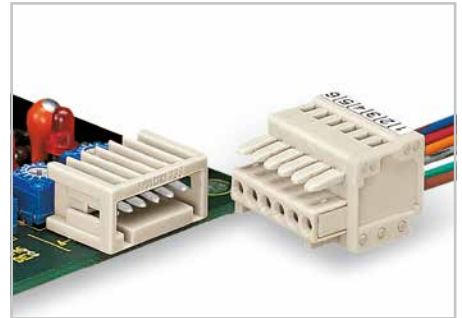

Male header and female connector – 100 % protected against mismatching
Only mating halves with the same pole number can be connected.

CAGE CLAMP® connection

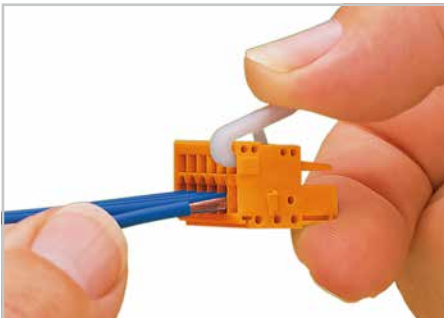

Inserting conductor via operating lever (734-230).

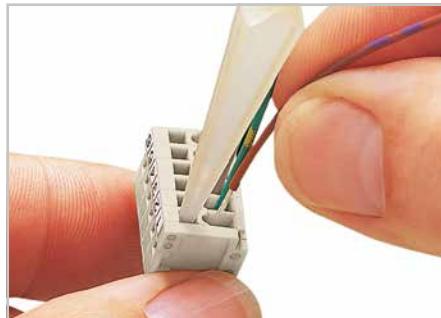

Inserting conductor via operating tool (233-332) – CAGE CLAMP® actuation parallel to conductor entry.

Testing



Testing with 1 mm Ø test pin (735-500) – touch contact.

Coding



Coding a male header – fitting coding key(s).

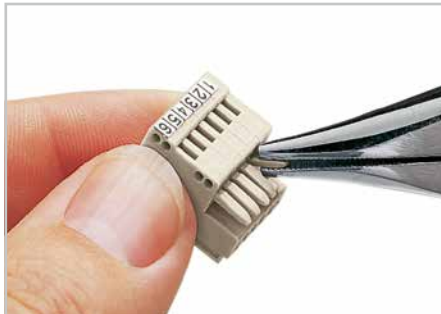

Coding a female connector – removing coding finger(s).

Marking



Factory marking or custom marking via self-adhesive strips.

Insulation stop



Prevents the insulation of smaller conductors from being inserted into the clamping unit.

Pin spacing: 10 mm

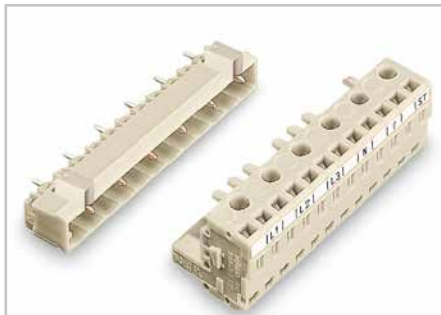

For 10 mm pin spacing, please contact factory.

Testing

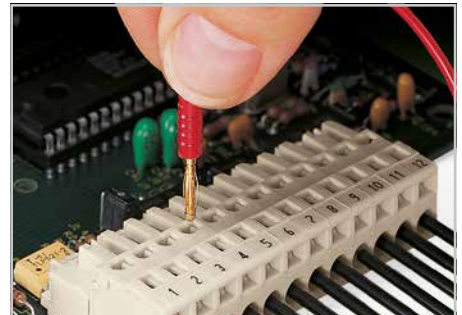

Testing with 2 mm or 2.3 mm Ø test plug.

* For other connection types, see full line catalog or visit www.wago.com.

MCS - MULTI CONNECTION SYSTEM

- Product Overview by Pin Spacing -

733 Series									
2.5 mm MICRO, 100 % Mismatching Protection, 160 V, 6 A									
Item No.	Pack. Unit	Item No.	Pack. Unit	Item No.	Pack. Unit	Item No.	Pack. Unit	Item No.	Pack. Unit
Male headers with straight solder pins, 2 ... 12 poles		Male headers with straight solder pins, 2 ... 12 poles		Male headers with press-in pins, 2 ... 12 poles		Female connectors, 2 ... 12 poles		Male connectors, 2 ... 12 poles	
○		●		○		○		○	
733-332	200	733-332/105-604	200	733-332/100-000	200	733-102	200	733-202	200
733-342	100	733-342/105-604	100	733-342/100-000	100	733-112	50	733-212	50
Male headers with angled solder pins, 2 ... 12 poles		Male headers with angled solder pins, 2 ... 12 poles				Female connectors with locking levers, 2 ... 12 poles			
○		●				○			
733-362	200	733-362/105-604	200			733-102/037-000	100		
733-372	100	733-372/105-604	100			733-112/037-000	50		

713 Series									
3.5 mm MINI HD, 100 % Mismatching Protection, 160 V, 10 A									
Item No.	Pack. Unit	Item No.	Pack. Unit	Item No.	Pack. Unit	Item No.	Pack. Unit	Item No.	Pack. Unit
Male headers with straight solder pins, 6 ... 36 poles		Male headers with angled solder pins, 6 ... 36 poles		Male headers with straight solder pins, 6 ... 36 poles		Male headers with angled solder pins, 6 ... 36 poles		Female connectors, 6 ... 36 poles	
●		●		●		●		●	
713-1403	100	713-1423	100	713-1403/105-000	100	713-1423/105-000	100	713-1103	100
713-1418	20	713-1438	20	713-1418/105-000	20	713-1438/105-000	20	713-1118	20
Male headers with straight solder pins and levers, 6 ... 36 poles		Male headers with angled solder pins and levers, 6 ... 36 poles		Male headers with straight solder pins and levers, 6 ... 36 poles		Male headers with angled solder pins and levers, 6 ... 36 poles		Female connectors with levers, 6 ... 36 poles	
●		●		●		●		●	
713-1403/037-000	50	713-1423/037-000	50	713-1403/116-000	50	713-1423/116-000	50	713-1103/037-000	50
713-1418/037-000	10	713-1438/037-000	10	713-1418/116-000	10	713-1438/116-000	10	713-1118/037-000	51
Male headers with straight solder pins and threaded flanges, 6 ... 36 poles		Male headers with angled solder pins and threaded flanges, 6 ... 36 poles		Male headers with straight solder pins and threaded flanges, 6 ... 36 poles		Male headers with angled solder pins and threaded flanges, 6 ... 36 poles		Female connectors with threaded flanges, 6 ... 36 poles	
●		●		●		●		●	
713-1403/107-000	50	713-1423/107-000	50	713-1403/117-000	50	713-1423/117-000	50	713-1103/107-000	50
713-1418/107-000	10	713-1438/107-000	10	713-1418/117-000	10	713-1438/117-000	10	713-1118/107-000	10

714 Series									
3.5 mm MINI SL, 160 V, 8 A									
Item No.	Pack. Unit	Item No.	Pack. Unit	Item No.	Pack. Unit				
Male headers with straight solder pins, 2 ... 16 poles		Male headers with angled solder pins, 2 ... 16 poles		Female connectors, 2 ... 16 poles					
●		●		●					
714-132	200	714-162	200	714-102	200				
714-146	100	714-176	100	714-116	50				
				0.2 ... 1.5 mm ² / 24 ... 16 AWG					

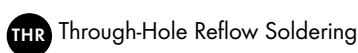
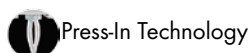



MCS – MULTI CONNECTION SYSTEM

– Product Overview by Pin Spacing –

734 / 2734 Series									
		3.5 mm		MINI, 100 % Mismatching Protection					
Item No.	Pack. Unit	Item No.	Pack. Unit	Item No.	Pack. Unit	Item No.	Pack. Unit	Item No.	Pack. Unit
Male headers with straight solder pins, 2 ... 24 poles		Female headers with straight solder pins, 2 ... 24 poles		Female connectors, 2 ... 24 poles		Male connectors, 2 ... 24 poles		Combi strips, 2 ... 12 poles	
○		○		○		○		○	
0.08 ... 1.5 mm ² / 28 ... 14 AWG		0.08 ... 1.5 mm ² / 28 ... 14 AWG		0.08 ... 1.5 mm ² / 28 ... 14 AWG		0.08 ... 1.5 mm ² / 28 ... 14 AWG		0.08 ... 1.5 mm ² / 28 ... 14 AWG	
734-132	200	734-462	200	734-102	200	734-302	200	734-362	100
734-154	50	734-484	25	734-124	25	734-324	25	734-372	25
Male headers with angled solder pins, 2 ... 24 poles		Female headers with angled solder pins, 2 ... 24 poles		Female connectors with locking levers, 2 ... 24 poles		Male connectors with mounting flanges, 2 ... 24 poles		Combi strips with locking levers, 2 ... 12 poles	
○		○		○		○		○	
0.08 ... 1.5 mm ² / 28 ... 14 AWG		0.08 ... 1.5 mm ² / 28 ... 14 AWG		0.08 ... 1.5 mm ² / 28 ... 14 AWG		0.08 ... 1.5 mm ² / 28 ... 14 AWG		0.08 ... 1.5 mm ² / 28 ... 14 AWG	
734-162	200	734-532	200	734-102/037-000	100	734-302/019-000	100	734-362/037-000	100
734-184	50	734-554	25	734-124/037-000	10	734-324/019-000	10	734-372/037-000	25
Male headers with straight solder pins, 2 ... 16 poles		Female headers with straight solder pins and locking levers, 2 ... 24 poles		Female connectors with snap-in mounting feet, 2 ... 24 poles		Male connectors with snap-in mounting feet, 2 ... 24 poles		Combi strips with snap-in mounting feet, 2 ... 12 poles	
THR		○		○		○		○	
0.08 ... 1.5 mm ² / 28 ... 14 AWG		0.08 ... 1.5 mm ² / 28 ... 14 AWG		0.08 ... 1.5 mm ² / 28 ... 14 AWG		0.08 ... 1.5 mm ² / 28 ... 14 AWG		0.08 ... 1.5 mm ² / 28 ... 14 AWG	
734-132/105-604	200	734-462/037-000	100	734-102/008-000	200	734-302/018-000	200	734-362/008-000	100
734-146/105-604	50	734-484/037-000	10	734-124/008-000	25	734-324/018-000	25	734-372/008-000	25
Male headers with angled solder pins, 2 ... 16 poles		Female headers with angled solder pins and locking levers, 2 ... 24 poles							
THR		○							
734-162/105-604	200	734-532/037-000	100						
734-176/105-604	50	734-554/037-000	10						
Male headers with straight press-in pins, 2 ... 12 poles								Female connectors with push-buttons, 2 ... 24 poles	
○								○	
0.2 ... 1.5 mm ² / 24 ... 14 AWG								0.2 ... 1.5 mm ² / 24 ... 14 AWG	
734-132/100-000	200							2734-102	200
734-142/100-000	100							2734-124	25
Double-deck male headers with angled solder pins, 4 ... 24 poles								Female connectors with push-buttons and locking levers, 2 ... 24 poles	
○								○	
0.2 ... 1.5 mm ² / 24 ... 14 AWG								0.2 ... 1.5 mm ² / 24 ... 14 AWG	
734-402	100							2734-102/037-000	100
734-412	50							2734-124/037-000	10
Double-deck male headers with angled solder pins and support, 4 ... 24 poles								Female connectors with push-buttons and mounting flanges, 2 ... 24 poles	
○								○	
0.2 ... 1.5 mm ² / 24 ... 14 AWG								0.2 ... 1.5 mm ² / 24 ... 14 AWG	
734-402/001-000	100							2734-102/031-000	100
734-412/001-000	50							2734-124/031-000	10
Male headers with straight solder pins and threaded flanges, 2 ... 24 poles		Male headers with angled solder pins and threaded flanges, 2 ... 24 poles		Female connectors with screw flanges, 2 ... 24 poles		Male connectors with threaded flanges, 2 ... 24 poles		Female connectors with push-buttons and screw flanges, 2 ... 24 poles	
○		○		○		○		○	
0.08 ... 1.5 mm ² / 28 ... 14 AWG		0.08 ... 1.5 mm ² / 28 ... 14 AWG		0.08 ... 1.5 mm ² / 28 ... 14 AWG		0.08 ... 1.5 mm ² / 28 ... 14 AWG		0.2 ... 1.5 mm ² / 24 ... 14 AWG	
734-132/108-000	200	734-162/108-000	200	734-102/107-000	100	734-302/109-000	100	2734-102/107-000	100
734-154/108-000	50	734-184/108-000	50	734-124/107-000	10	734-324/109-000	10	2734-124/107-000	10

MCS - MULTI CONNECTION SYSTEM

- Product Overview by Pin Spacing -

734 / 2734 Series									
Item No.	Pack. Unit	Item No.	3.81 mm Pack. Unit	Item No.	MINI, 100 % Mismatching Protection Pack. Unit	Item No.	Pack. Unit	Item No.	Pack. Unit
Male headers with straight solder pins, 2 ... 20 poles		Female headers with straight solder pins, 2 ... 20 poles		Female connectors, 2 ... 20 poles		Male connectors, 2 ... 20 poles		Female connectors with push-buttons, 2 ... 20 poles	
734-232	200	734-502	200	734-202	200	734-332	200	2734-202	200
734-250	50	734-520	25	734-220	25	734-350	25	2734-220	25
Male headers with angled solder pins, 2 ... 20 poles		Female headers with angled solder pins, 2 ... 20 poles		Female connectors with locking levers, 2 ... 20 poles		Male connectors with mounting flanges, 2 ... 20 poles		Female connectors with push-buttons and locking levers, 2 ... 20 poles	
734-262	200	734-562	200	734-202/037-000	100	734-332/019-000	100	2734-202/037-000	100
734-280	50	734-580	25	734-220/037-000	10	734-350/019-000	10	2734-220/037-000	10
Male headers with straight solder pins, 2 ... 16 poles		Female headers with straight solder pins and locking levers, 2 ... 20 poles		Female connectors with snap-in mounting feet, 2 ... 20 poles		Male connectors with snap-in mounting feet, 2 ... 20 poles		Female connectors with push-buttons and mounting flanges, 2 ... 20 poles	
734-232/105-604	200	734-502/037-000	100	734-202/008-000	200	734-332/018-000	200	2734-202/031-000	100
734-242/105-604	100	734-520/037-000	10	734-220/008-000	25	734-350/018-000	25	2734-220/031-000	10
Male headers with angled solder pins, 2 ... 16 poles		Female headers with angled solder pins and locking levers, 2 ... 20 poles							
734-262/105-604	200	734-562/037-000	100						
734-272/105-604	100	734-580/037-000	10						
Male headers with straight press-in pins, 2 ... 12 poles									
734-232/100-000	200								
734-242/100-000	100								
Double-deck male headers with angled solder pins, 4 ... 24 poles									
734-432	100								
734-442	50								
Double-deck male headers with angled solder pins and support, 4 ... 24 poles									
734-432/001-000	100								
734-442/001-000	50								































MCS – MULTI CONNECTION SYSTEM

– Product Overview by Pin Spacing –

721 / 722 / 2721 Series									
5 mm MIDI, 100 % Mismatching Protection, 320 V, 12 A (16 A)									
Item No.	Pack. Unit	Item No.	Pack. Unit	Item No.	Pack. Unit	Item No.	Pack. Unit	Item No.	Pack. Unit
Male headers with straight solder pins, 2 ... 20 poles		Female headers with straight solder pins, 2 ... 20 poles		Female connectors, 2 ... 20 poles		Male connectors, 2 ... 20 poles		Female connectors with push-buttons, 2 ... 20 poles	
○		○		○		○		○	
721-132/001-000	200	722-132	100	721-102/026-000	100	721-602	100	2721-102/026-000	100
721-150/001-000	50	722-150	10	721-120/026-000	10	721-620	10	2721-120/026-000	10
Male headers with angled solder pins, 2 ... 20 poles		Female headers with angled solder pins, 2 ... 20 poles		Female connectors with locking levers, 2 ... 20 poles		Male connectors with mounting flanges, 2 ... 20 poles		Female connectors with push-buttons and locking levers, 2 ... 20 poles	
○		○		○		○		○	
721-432/001-000	200	722-232	100	721-102/037-000	100	721-602/019-000	100	2721-102/037-000	100
721-450/001-000	50	722-250	10	721-120/037-000	10	721-620/019-000	10	2721-120/037-000	10
Male headers with straight press-in pins, 8 A, 2 ... 12 poles		Female headers with straight solder pins and locking levers, 2 ... 20 poles		Female connectors with snap-in mounting feet, 2 ... 20 poles		Male connectors with snap-in mounting feet, 2 ... 20 poles		Female connectors with push-buttons and snap-in mounting feet, 2 ... 20 poles	
○		○		○		○		○	
721-162/100-000	200	722-132/039-000	100	721-102/008-000	100	721-602/018-000	100	2721-102/008-000	100
721-172/100-000	100	722-150/039-000	10	721-120/008-000	10	721-620/018-000	10	2721-120/008-000	10
Male headers with straight solder pins, 16 A, 2 ... 20 poles		Female headers with angled solder pins and locking levers, 2 ... 20 poles		Female connectors with mounting flanges, 2 ... 20 poles		Male connectors with snap-in flanges, 2 ... 20 poles		Female connectors with push-buttons and mounting flanges, 2 ... 20 poles	
○		○		○		○		○	
721-162/001-000	200	722-232/039-000	100	721-102/031-000	100	721-602/114-000	100	2721-102/031-000	100
721-180/001-000	50	722-250/039-000	10	721-120/031-000	10	721-620/114-000	10	2721-120/031-000	10
Male headers with angled solder pins, 16 A, 2 ... 20 poles		Female headers with straight solder pins and mounting flanges, 2 ... 20 poles		Angled female connectors, conductor entry same direction as latches, 2 ... 20 poles					
○		○		○					
721-462/001-000	200	722-132/031-000	100	722-202/026-000	100				
721-480/001-000	50	722-150/031-000	10	722-220/026-000	10				
Male connectors for rail-mounted terminal blocks, 2 ... 20 poles		Female headers with angled solder pins and mounting flanges, 2 ... 20 poles		Angled female connectors, conductor entry opposite of latches, 2 ... 20 poles					
○		○		○					
721-162/003-000	200	722-232/031-000	100	722-102/026-000	100				
721-180/003-000	50	722-250/031-000	10	722-120/026-000	10				
Female connectors for rail-mounted terminal blocks, 2 ... 20 poles		Female headers with straight solder pins and spacers, 2 ... 20 poles		2-conductor female connectors, 2 ... 16 poles				Female connectors with flanges for panel mounting, 2 ... 20 poles	
○		○		○				○	
722-132/005-000	100	722-132/047-000	100	721-2102/026-000	100			721-302/031-000	100
722-150/005-000	10	722-150/047-000	10	721-2116/026-000	25			721-320/031-000	10
Female connectors with locking levers for rail-mounted terminal blocks, 2 ... 20 poles		Female headers with angled solder pins and spacers, 2 ... 20 poles		2-conductor female connectors with locking levers, 2 ... 16 poles				Female connectors with snap-in feet for panel mounting, 2 ... 20 poles	
○		○		○				○	
722-132/005-000/039-000	100	722-232/047-000	100	721-2102/037-000	100			721-302/008-000	100
722-150/005-000/039-000	10	722-250/047-000	10	721-2116/037-000	10			721-320/008-000	10

MCS - MULTI CONNECTION SYSTEM

- Product Overview by Pin Spacing -

231 / 232 / 731 / 231 Series 5 mm, MIDI Classic, 320 V, 12 A									
Item No.	Pack. Unit	Item No.	Pack. Unit	Item No.	Pack. Unit	Item No.	Pack. Unit	Item No.	Pack. Unit
Male headers with straight solder pins, 2 ... 24 poles 		Female headers with straight solder pins, 2 ... 24 poles 		Female connectors, 2 ... 24 poles 		Male connectors, 2 ... 24 poles 		Female connectors with push-buttons, 2 ... 24 poles 	
231-132/001-000 200 231-154/001-000 50		232-132 100 232-154 10		0.08 ... 2.5 mm ² / 28 ... 12 AWG 231-102/026-000 100 231-124/026-000 10		0.08 ... 2.5 mm ² / 28 ... 12 AWG 231-602 100 231-624 10		0.2 ... 2.5 mm ² / 24 ... 12 AWG 2231-102/026-000 100 2231-124/026-000 10	
Male headers with angled solder pins, 2 ... 24 poles 		Female headers with angled solder pins, 2 ... 24 poles 		Female connectors with locking levers, 2 ... 24 poles 		Male connectors with mounting flanges, 2 ... 24 poles 		Female connectors with push-buttons and locking levers, 2 ... 24 poles 	
231-432/001-000 200 231-454/001-000 50		232-232 100 232-254 10		0.08 ... 2.5 mm ² / 28 ... 12 AWG 231-102/037-000 100 231-124/037-000 10		0.08 ... 2.5 mm ² / 28 ... 12 AWG 231-602/019-000 100 231-624/019-000 10		0.2 ... 2.5 mm ² / 24 ... 12 AWG 2231-102/037-000 100 2231-124/037-000 10	
Male headers with straight solder pins and mounting flanges, 2 ... 14 poles 		Female headers with straight solder pins and locking levers, 2 ... 24 poles 		Female connectors with snap-in mounting feet, 2 ... 24 poles 		Male connectors with snap-in mounting feet, 2 ... 24 poles 		Female connectors with push-buttons and snap-in mounting feet, 2 ... 24 poles 	
231-132/040-000 200 231-144/040-000 50		232-132/039-000 100 232-154/039-000 10		0.08 ... 2.5 mm ² / 28 ... 12 AWG 231-102/008-000 100 231-124/008-000 10		0.08 ... 2.5 mm ² / 28 ... 12 AWG 231-602/018-000 100 231-624/018-000 10		0.2 ... 2.5 mm ² / 24 ... 12 AWG 2231-102/008-000 100 2231-124/008-000 10	
Male headers with angled solder pins and mounting flanges, 2 ... 14 poles 		Female headers with angled solder pins and locking levers, 2 ... 24 poles 		Female connectors with mounting flanges, 2 ... 24 poles 		Male connectors with snap-in flanges, 2 ... 24 poles 		Female connectors with push-buttons and mounting flanges, 2 ... 24 poles 	
231-432/040-000 200 231-444/040-000 50		232-232/039-000 100 232-254/039-000 10		0.08 ... 2.5 mm ² / 28 ... 12 AWG 231-102/031-000 100 231-124/031-000 10		0.08 ... 2.5 mm ² / 28 ... 12 AWG 231-602/114-000 50 231-624/114-000 10		0.2 ... 2.5 mm ² / 24 ... 12 AWG 2231-102/031-000 100 2231-124/031-000 10	
Male headers with straight solder pins, 2 ... 12 poles 	THR	Female headers with straight solder pins and mounting flanges, 2 ... 24 poles 		Angled female connectors, conductor entry same direction as latches, 2 ... 24 poles 				Female connectors with push-buttons and integrated end plate, 2 ... 24 poles 	
231-132/001-000/105-604 200 231-142/001-000/105-604 100		232-132/031-000 100 232-154/031-000 10		0.08 ... 2.5 mm ² / 28 ... 12 AWG 232-202/026-000 100 232-224/026-000 10				0.2 ... 2.5 mm ² / 24 ... 12 AWG 2231-102/102-000 100 2231-124/102-000 10	
Male headers with angled solder pins, 2 ... 12 poles 	THR	Female headers with angled solder pins and mounting flanges, 2 ... 24 poles 		Angled female connectors, conductor entry opposite of latches, 2 ... 24 poles 				Double-pin male connectors for DIN-35 rail mounting, 2 ... 24 poles 	
231-432/001-000/105-604 200 231-442/001-000/105-604 100		232-232/031-000 100 232-254/031-000 10		0.08 ... 2.5 mm ² / 28 ... 12 AWG 232-102/026-000 100 232-124/026-000 10				232-502/007-000 100 232-524/007-000 10	
Double-deck male headers, 2 ... 16 poles 				2-conductor female connectors, 2 ... 16 poles 				Female connectors with mounting flanges for panel mounting, 2 ... 20 poles 	
232-332 100 232-346 25				0.2 ... 2.5 mm ² / 24 ... 12 AWG 231-2102/026-000 100 231-2116/026-000 25				0.08 ... 2.5 mm ² / 28 ... 12 AWG 731-502/031-000 100 731-520/031-000 10	
Male connectors for rail-mounted terminal blocks, 2 ... 20 poles 		Female connectors for rail-mounted terminal blocks, 2 ... 20 poles 		2-conductor female connectors with locking levers, 2 ... 16 poles 				Female connectors with snap-in feet for panel mounting, 2 ... 20 poles 	
231-162/003-000 200 231-180/003-000 50		232-132/005-000 100 232-150/005-000 10		0.2 ... 2.5 mm ² / 24 ... 12 AWG 231-2102/037-000 100 231-2116/037-000 10				0.08 ... 2.5 mm ² / 28 ... 12 AWG 731-502/008-000 100 731-520/008-000 10	

MCS – MULTI CONNECTION SYSTEM

– Product Overview by Pin Spacing –

231 / 232 / 731 / 2231 Series									
5.08 mm MIDI Classic, 320 V, 12 A (16 A)									
Item No.	Pack. Unit	Item No.	Pack. Unit	Item No.	Pack. Unit	Item No.	Pack. Unit	Item No.	Pack. Unit
Male headers with straight solder pins, 2 ... 24 poles		Female headers with straight solder pins, 2 ... 24 poles		Female connectors, 2 ... 24 poles		Male connectors, 2 ... 24 poles		Female connectors with push-buttons, 2 ... 24 poles	
●		●		●		●		●	
231-332/001-000	200	232-162	100	231-302/026-000	100	231-632	100	2231-302/026-000	100
231-354/001-000	50	232-184	10	231-324/026-000	10	231-654	10	2231-324/026-000	10
Male headers with angled solder pins, 2 ... 24 poles		Female headers with angled solder pins, 2 ... 24 poles		Female connectors with locking levers, 2 ... 24 poles		Male connectors with mounting flanges, 2 ... 24 poles		Female connectors with push-buttons and locking levers, 2 ... 24 poles	
●		●		●		●		●	
231-532/001-000	200	232-262	100	231-302/037-000	100	231-632/019-000	100	2231-302/037-000	100
231-554/001-000	50	232-284	10	231-324/037-000	10	231-654/019-000	10	2231-324/037-000	10
Male headers with straight solder pins, 16 A, 2 ... 24 poles		Female headers with straight solder pins and locking levers, 2 ... 24 poles		Female connectors with snap-in mounting feet, 2 ... 24 poles		Male connectors with snap-in mounting feet, 2 ... 24 poles		Female connectors with push-buttons and snap-in mounting feet, 2 ... 24 poles	
●		●		●		●		●	
231-362/001-000	200	232-162/039-000	100	231-302/008-000	100	231-632/018-000	100	2231-302/008-000	100
231-384/001-000	50	232-184/039-000	10	231-324/008-000	10	231-654/018-000	10	2231-324/008-000	10
Male headers with angled solder pins, 16 A, 2 ... 24 poles		Female headers with angled solder pins and locking levers, 2 ... 24 poles		Female connectors with mounting flanges, 2 ... 24 poles		Male connectors with snap-in flanges, 2 ... 24 poles		Female connectors with push-buttons and mounting flanges, 2 ... 24 poles	
●		●		●		●		●	
231-562/001-000	200	232-262/039-000	100	231-302/031-000	100	231-632/114-000	50	2231-302/031-000	100
231-584/001-000	50	232-284/039-000	10	231-324/031-000	10	231-654/114-000	10	2231-324/031-000	10
Double-deck male headers, 2 ... 16 poles		Female headers with straight solder pins and mounting flanges, 2 ... 24 poles		2-conductor female connectors, 2 ... 16 poles				Angled female connectors, conductor entry same direction as latches, 2 ... 24 poles	
●		●		●				●	
232-362	100	232-162/031-000	100	231-2302/026-000	100			232-402/026-000	100
232-376	25	232-184/031-000	10	231-2316/026-000	25			232-424/026-000	10
		Female headers with angled solder pins and mounting flanges, 2 ... 24 poles		2-conductor female connectors with locking levers, 2 ... 16 poles				Angled female connectors, conductor entry opposite of latches, 2 ... 24 poles	
		●		●				●	
		232-262/031-000	100	231-2302/037-000	100			232-302/026-000	100
		232-284/031-000	10	231-2316/037-000	10			232-324/026-000	10
Male headers with straight solder pins and threaded flanges, 2 ... 16 poles				2-conductor female connectors with screw flanges, 2 ... 16 poles		Male connectors with snap-in and threaded flanges, 2 ... 16 poles		Double-pin male connectors for DIN-35 rail mounting, 2 ... 24 poles	
●				●		●		●	
231-332/108-000	200			231-2302/107-000	100	231-632/129-000	50	232-532/007-000	100
231-346/108-000	50			231-2316/107-000	10	231-646/129-000	10	232-554/007-000	10
Male headers with angled solder pins and threaded flanges, 2 ... 16 poles				Female connectors with screw flanges, 2 ... 16 poles		Male connectors with threaded flanges, 2 ... 16 poles		Female connectors with push-buttons and screw flanges, 2 ... 24 poles	
●				●		●		●	
231-532/108-000	200			231-302/107-000	100	231-632/109-000	100	2231-302/107-000	100
231-546/108-000	50			231-316/107-000	10	231-646/109-000	10	2231-316/107-000	10

MCS - MULTI CONNECTION SYSTEM

- Product Overview by Pin Spacing -

721 / 722 / 723 / 2721 Series									
7.5 mm MIDI, 100 % Mismatching Protection, 630 V, 12 A (16 A)									
Item No.	Pack. Unit	Item No.	Pack. Unit	Item No.	Pack. Unit	Item No.	Pack. Unit	Item No.	Pack. Unit
Male headers with straight solder pins, 2 ... 12 poles		Female headers with straight solder pins, 2 ... 12 poles		Female connectors, 2 ... 12 poles		Male connectors, 2 ... 12 poles		Female connectors with push-buttons, 2 ... 12 poles	
721-232/001-000	200	722-732	100	721-202/026-000	100	723-602	100	2721-202/026-000	100
721-242/001-000	50	722-742	10	721-212/026-000	25	723-612	25	2721-212/026-000	25
Male headers with angled solder pins, 2 ... 12 poles		Female headers with angled solder pins, 2 ... 12 poles		Female connectors with locking levers, 2 ... 12 poles		Male connectors with mounting flanges, 2 ... 12 poles		Female connectors with push-buttons and locking levers, 2 ... 20 poles	
721-832/001-000	200	722-832	100	721-202/037-000	50	723-602/019-000	100	2721-202/037-000	50
721-842/001-000	50	722-842	10	721-212/037-000	10	723-612/019-000	25	2721-212/037-000	10
Male headers with straight solder pins, 16 A, 2 ... 12 poles		Female headers with straight solder pins and locking levers, 2 ... 12 poles		Female connectors with snap-in mounting feet, 2 ... 12 poles		Male connectors with snap-in mounting feet, 2 ... 12 poles		Female connectors with push-buttons and snap-in mounting feet, 2 ... 12 poles	
721-262/001-000	200	722-732/039-000	100	721-202/008-000	50	723-602/018-000	100	2721-202/008-000	100
721-272/001-000	50	722-742/039-000	10	721-212/008-000	10	723-612/018-000	25	2721-212/008-000	25
Male headers with angled solder pins, 16 A, 2 ... 12 poles		Female headers with angled solder pins and locking levers, 2 ... 12 poles		Female connectors with mounting flanges, 2 ... 12 poles		Male connectors with snap-in flanges, 2 ... 12 poles		Female connectors with push-buttons and mounting flanges, 4 ... 12 poles	
721-862/001-000	200	722-832/039-000	100	721-202/031-000	50	723-602/114-000	100	2721-202/031-000	50
721-872/001-000	50	722-842/039-000	10	721-212/031-000	10	723-612/114-000	25	2721-212/031-000	10
		Female headers with straight solder pins and mounting flanges, 2 ... 12 poles		2-conductor female connectors, 2 ... 16 poles					
				0.2 ... 2.5 mm ² / 24 ... 12 AWG					
				722-732/031-000	100	721-2202/026-000	100		
				722-742/031-000	10	721-2212/026-000	25		
		Female headers with angled solder pins and mounting flanges, 2 ... 12 poles		2-conductor female connectors with locking levers, 2 ... 16 poles					
				0.2 ... 2.5 mm ² / 24 ... 12 AWG					
				722-832/031-000	100	721-2202/037-000	100		
				722-842/031-000	10	721-2212/037-000	25		
		Female headers with straight solder pins and spacers, 2 ... 12 poles						Female connectors with flanges for panel mounting, 2 ... 12 poles	
								0.08 ... 2.5 mm ² / 28 ... 12 AWG	
				722-732/047-000	100			721-332/031-000	50
				722-742/047-000	10			721-342/031-000	10
		Female headers with angled solder pins and spacers, 2 ... 12 poles						Female connectors with snap-in feet for panel mounting, 2 ... 12 poles	
								0.08 ... 2.5 mm ² / 28 ... 12 AWG	
				722-832/047-000	100			721-332/008-000	100
				722-842/047-000	10			721-342/008-000	25

























MCS – MULTI CONNECTION SYSTEM







– Product Overview by Pin Spacing –

231 / 232 / 731 / 732 / 2231 Series									
7.5 mm MIDI Classic, 100 % Mismatching Protection, 630 V, 12 A (16 A)									
Item No.	Pack. Unit	Item No.	Pack. Unit	Item No.	Pack. Unit	Item No.	Pack. Unit	Item No.	Pack. Unit
Male headers with straight solder pins, 2 ... 16 poles		Female headers with straight solder pins, 2 ... 16 poles		Female connectors, 2 ... 16 poles		Male connectors, 2 ... 16 poles		Female connectors with push-buttons, 2 ... 16 poles	
231-232/001-000	200	232-732	100	231-202/026-000	100	731-602	100	2231-202/026-000	100
231-246/001-000	50	232-746	10	231-216/026-000	10	731-616	10	2231-216/026-000	10
Male headers with angled solder pins, 2 ... 16 poles		Female headers with angled solder pins, 2 ... 16 poles		Female connectors with locking levers, 2 ... 16 poles		Male connectors with mounting flanges, 2 ... 16 poles		Female connectors with push-buttons and locking levers, 2 ... 16 poles	
231-832/001-000	200	232-832	100	231-202/037-000	50	731-602/019-000	100	2231-202/037-000	50
231-846/001-000	50	232-846	10	231-216/037-000	10	731-616/019-000	10	2231-216/037-000	10
Male headers with straight solder pins, 16 A, 2 ... 16 poles		Female headers with straight solder pins and locking levers, 2 ... 16 poles		Female connectors with snap-in mounting feet, 2 ... 16 poles		Male connectors with snap-in mounting feet, 2 ... 16 poles		Female connectors with push-buttons and snap-in mounting feet, 2 ... 16 poles	
231-262/001-000	200	232-732/039-000	100	231-202/008-000	100	731-602/018-000	100	2231-202/008-000	100
231-276/001-000	50	232-746/039-000	10	231-216/008-000	10	731-616/018-000	10	2231-216/008-000	10
Male headers with angled solder pins, 16 A, 2 ... 16 poles		Female headers with angled solder pins and locking levers, 2 ... 16 poles		Female connectors with mounting flanges, 2 ... 16 poles		Male connectors with snap-in mounting flanges, 2 ... 16 poles		Female connectors with push-buttons and mounting flanges, 2 ... 16 poles	
231-862/001-000	200	232-832/039-000	100	231-202/031-000	50	731-602/114-000	50	2231-202/031-000	50
231-876/001-000	50	232-846/039-000	10	231-216/031-000	10	731-616/114-000	10	2231-216/031-000	10
Male headers with straight solder pins, 2 ... 12 poles		Female headers with straight solder pins and mounting flanges, 2 ... 16 poles		2-conductor female connectors, 2 ... 12 poles					
231-232/001-000/105-604	200	232-732/031-000	100	231-2202/026-000	100				
231-242/001-000/105-604	50	232-746/031-000	10	231-2212/026-000	25				
Male headers with angled solder pins, 2 ... 12 poles		Female headers with angled solder pins and mounting flanges, 2 ... 16 poles		2-conductor female connectors with locking levers, 2 ... 12 poles				Double-pin male connectors for DIN-35 rail mounting, 2 ... 12 poles	
231-832/001-000/105-604	200	232-832/031-000	100	231-2202/037-000	100			232-562/007-000	50
231-842/001-000/105-604	50	232-846/031-000	10	231-2212/037-000	25			232-572/007-000	10
Male headers with straight solder pins, 16 A, 2 ... 12 poles		Female headers with straight solder pins and spacers, 2 ... 16 poles						Angled female connectors with mounting flanges, 2 ... 24 poles	
231-262/001-000/105-604	200	232-732/047-000	100					731-532/031-000	50
231-272/001-000/105-604	50	232-746/047-000	10					731-546/031-000	10
Male headers with angled solder pins, 16 A, 2 ... 12 poles		Female headers with angled solder pins and spacers, 2 ... 16 poles						Angled female connectors with snap-in mounting feet, 2 ... 12 poles	
231-862/001-000/105-604	200	232-832/047-000	100					731-532/008-000	100
231-872/001-000/105-604	50	232-846/047-000	10					731-546/008-000	10

MCS - MULTI CONNECTION SYSTEM

- Product Overview by Pin Spacing -

231 / 232 / 731 / 2231 Series									
7.62 mm MIDI Classic, 100 % Mismatching Protection, 630 V, 12 A (16 A)									
Item No.	Pack. Unit	Item No.	Pack. Unit	Item No.	Pack. Unit	Item No.	Pack. Unit	Item No.	Pack. Unit
Male headers with straight solder pins, 2 ... 12 poles		Female headers with straight solder pins, 2 ... 12 poles		Female connectors, 2 ... 12 poles		Male connectors, 2 ... 12 poles		Female connectors with push-buttons, 2 ... 12 poles	
231-732/001-000	200	232-762	100	231-702/026-000	100	731-632	50	2231-702/026-000	100
231-742/001-000	50	232-772	10	231-712/026-000	10	731-642	10	2231-712/026-000	10
Male headers with angled solder pins, 2 ... 12 poles		Female headers with angled solder pins, 2 ... 12 poles		Female connectors with locking levers, 2 ... 12 poles		Male connectors with mounting flanges, 2 ... 12 poles		Female connectors with push-buttons and locking levers, 2 ... 12 poles	
231-932/001-000	200	232-862	100	231-702/037-000	50	731-632/019-000	50	2231-702/037-000	50
231-942/001-000	50	232-872	10	231-712/037-000	10	731-642/019-000	10	2231-712/037-000	10
Male headers with straight solder pins, 16 A, 2 ... 12 poles		Female headers with straight solder pins and locking levers, 2 ... 12 poles		Female connectors with snap-in mounting feet, 2 ... 12 poles		Male connectors with snap-in mounting feet, 2 ... 12 poles		Female connectors with push-buttons and snap-in mounting feet, 2 ... 12 poles	
231-762/001-000	200	232-762/039-000	100	231-702/008-000	100	731-632/018-000	100	2231-702/008-000	100
231-772/001-000	50	232-772/039-000	10	231-712/008-000	10	731-642/018-000	10	2231-712/008-000	10
Male headers with angled solder pins, 16 A, 2 ... 12 poles		Female headers with angled solder pins and locking levers, 2 ... 12 poles		Female connectors with mounting flanges, 2 ... 12 poles		Male connectors with snap-in flanges, 2 ... 12 poles		Female connectors with push-buttons and mounting flanges, 2 ... 12 poles	
231-962/001-000	200	232-862/039-000	100	231-702/031-000	50	731-632/114-000	50	2231-702/031-000	50
231-972/001-000	50	232-872/039-000	10	231-712/031-000	10	731-646/114-000	10	2231-712/031-000	10
		Female headers with straight solder pins and mounting flanges, 2 ... 12 poles		2-conductor female connectors, 2 ... 12 poles		Double-pin male connectors for DIN-35 rail mounting, 2 ... 12 poles		Angled female connectors, conductor entry opposite of latches, 2 ... 12 poles	
		232-762/031-000	100	231-2702/026-000	100	232-582/007-000	50	732-122/026-000	100
		232-772/031-000	10	231-2712/026-000	25	232-592/007-000	10	732-132/026-000	25

831 Series									
7.62 mm MAXI, 100 % Mismatching Protection, 1,000 V, 41 A									
Item No.	Pack. Unit	Item No.	Pack. Unit	Item No.	Pack. Unit	Item No.	Pack. Unit	Item No.	Pack. Unit
Male headers with straight solder pins, 2 ... 9 poles		Female connectors, 2 ... 9 poles		Male connectors, 2 ... 9 poles		Male connectors with integrated mounting adapter for DIN-35 rail, 2 ... 9 poles			
831-3602	48			831-3102	48	831-3202	48	831-3202/007-000	48
831-3609	12			831-3109	12	831-3209	12	831-3209/007-000	12
Male headers with angled solder pins, 2 ... 9 poles		Female connectors with locking levers, 2 ... 9 poles							
831-3622	48			831-3102/037-000	48				
831-3629	12			831-3109/037-000	12				

MCS - MULTI CONNECTION SYSTEM MIDI Classic

Multi Mounting Adapter, Strain Relief Housings, Accessories

Multi mounting adapter for male and female connectors with snap-in mounting feet

Adapter width: 10 mm/0.394 in.

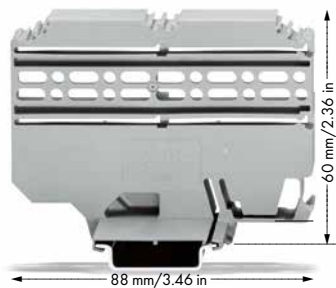

Snap-on type strain relief housings for:
- female connectors with CAGE CLAMP®
- male connectors with CAGE CLAMP®



Accessories

Color	Item No.	Pack. Unit
Test plug, with 500 mm cable		
	2 mm Ø	210-136 50
	2.3 mm Ø	210-137 50
Test plug adapter, for female connectors, light gray		
	5/5.08 mm pin spacing	231-661 100
	7.5/7.62 mm pin spacing	231-662 100

Color	Item No.	Pack. Unit
	209-148	25

Pole No.	Item No.	Item No.	Pack. Unit
Snap-on type strain relief housing, consists of strain relief support and housing, for 734 Series			
3.5 mm pin spacing 3.81 mm pin spacing			
	light gray	orange	
2	734-602 ①	734-632 ①	50
3	734-603 ①	734-633 ①	25
:	:	:	
6	734-606	734-636	25
7	734-607	-	25
8	734-608	734-638	25
9	734-609	734-639	25
10	734-610	734-640	25
12	734-612	734-642	25

		231-193 100
		231-391 100
Screw with nut, M 2 x 12, for fixing element		
		231-195 100



If either the male or the female connector is equipped with mounting feet and mounted on the adapter via its oblong holes or open grooves (A/B), but the mating half is not, then the connection remains pluggable.



The adapter can be marked either with WMB or miniature WSB markers.



for 231 and 721 Series			
5 mm pin spacing 5.08 mm pin spacing			
2	232-602	232-632	25
3	232-603	232-633	25
:	:	:	
6	232-606	232-636	25
7	232-607	-	25
8	232-608	232-638	25
9	232-609	232-639	25
10	232-610	232-640	25
12	232-612	232-642	25

for 231, 721 and 731 Series			
7.5 mm pin spacing 7.62 mm pin spacing			
2	232-662 ②	232-682 ②	25
3	232-663 ②	232-683 ②	25
4	232-664	232-684	25
5	232-665	232-685	25
7	232-667	232-687	25

Cable clamp, for strain relief	209-177	25
	Pole no.:	Pin spacing (mm):
	6 ... 12 poles	3.5 + 3.81
	4 ... 6 poles	5 + 5.08
	3 poles	7.5 + 7.62
Cable clamp, for strain relief	209-174	25
	7 or more poles	5 + 5.08
	5 or more poles	7.5 + 7.62

Fixing screw, for cable clamp	209-176	50
	Pole no.:	Pin spacing (mm):
	4 ... 6 poles	5 + 5.08
	3 poles	7.5 + 7.62
Fixing screw, for cable clamp	209-172	50
	6 ... 12 poles	3.5 + 3.81
	7 or more poles	5 + 5.08
	5 or more poles	7.5 + 7.62

Fixing screw, for cable clamp	209-173	50
	Pole no.:	Pin spacing (mm):
	4 ... 6 poles	5 + 5.08
	3 poles	7.5 + 7.62

Mounting adapter		209-137 1
Spacer, for male connectors		
		231-500 200

Lockout cap		
		231-668 500
		231-669 500

Operating tool with a partially insulated shaft,		
	type 1, (2.5 x 0.4) mm blade	
		210-719 1
	type 2, (3.5 x 0.5) mm blade	
		210-720 1





Operating tool, for male and female connectors equipped with CAGE CLAMP® connection		
	MINI/MIDI	210-250 1
	MINI/MICRO	210-251 1

Comb-style jumper bar, for 5/5.08 mm pin spacing		
	2-way	231-902 200
	3-way	231-903 100
	5-way	231-905 100
	7-way	231-907 100
	10-way	231-910 100





Marking strip, 100 self-adhesive strips		
2.5 mm pin spacing		
	1 ... 16 (400x)	210-331/250-202
3.5 mm pin spacing		
	1 ... 16 (240x)	210-332/350-202
3.81 mm pin spacing		
	1 ... 16 (160x)	210-332/381-202
5 mm pin spacing		
	1 ... 12 (300x)	210-331/500-103
5.08 mm pin spacing		
	1 ... 16 (200x)	210-331/508-103
7.5 mm pin spacing		
	1 ... 16 (100x)	210-331/750-202
7.62 mm pin spacing		
	1 ... 16 (100x)	210-331/762-202

① 2 ... 5 poles only suitable for cable ties (734 Series) ② 2 ... 3 poles only suitable for cable ties (231, 721 and 731 Series)



MCS – MULTI CONNECTION SYSTEM MINI and MIDI Accessories

	733 Series Pin Spacing: 2.5 mm			734 Series Pin Spacing: 3.5 mm			231 / 721 / 722 Series					
	Color	Item No.	Pack. Unit	Color	Item No.	Pack. Unit	Pin Spacing: 5 mm			Pin Spacing: 7.5 mm		
							Color	Item No.	Pack. Unit	Color	Item No.	Pack. Unit
Coding keys for male connectors 	○ ●	733-330 733-331	100 100	○ ● ○	734-130 734-159 734-400	100 100 100	○ ○	231-129 231-160	100 100	○	231-130	100
Insulation stops 		-		○	734-671	8x25	○ ○ ●	231-670 231-671 231-672	200 200 200	○ ○ ●	231-673 231-674 231-675	200 200 200
Operating levers 	○ ●	733-130 733-191	4x25 4x25	○ ●	734-230 734-191	4x25 4x25	○ ●	231-131 231-291	4x25 4x25	○ ●	231-131 231-291	4x25 4x25
Operating tools 	○ ●	233-332 233-331	25 25	○ ●	734-190 734-231	4x25 4x25	○ ●	231-159 231-231	4x25 4x25	○ ●	231-159 231-231	4x25 4x25

Field-Assembled Strain Relief Plates for Female Connectors

	Pin Spacing	Pole No.	Width	Color/Item No.			Pack. Unit	Pole No.	Pin Spacing	
	2.5 mm	2 ... 4	6 mm	○ 734-127	● 734-327	● 734-227	4x25	2 ... 3	3.5 / 3.81 mm	
		5 ... 9	12.5 mm	○ 734-128	● 734-328	● 734-228	4x25	4 ... 8		
		10 ... 12	25 mm	○ 734-129	● 734-329	● 734-229	4x25	9 ... 12		
		-	35 mm	○ 734-126	● 734-326	● 734-226	4x25	13 ... 16		
		-	55 mm	○ 734-426	● 734-430	● 734-428	2x25	17 ... max.		
	5 / 5.08 mm	2	6 mm	○ 734-127	● 734-327	● 734-227	4x25	-	7.5 / 7.62 mm	
		3 ... 4	12.5 mm	○ 734-128	● 734-328	● 734-228	4x25	2 ... 3		
		5 ... 7	25 mm	○ 734-129	● 734-329	● 734-229	4x25	4 ... 6		
		8 ... 11	35 mm	○ 734-126	● 734-326	● 734-226	4x25	7 ... 9		
		12 ... 16	55 mm	○ 734-426	● 734-430	● 734-428	2x25	10 ... 12		
		17 ... 24	75 mm	○ 734-427	● 734-431	● 734-429	2x25	13 ... 16		

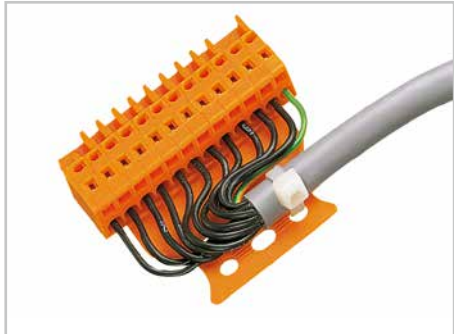
Factory-Assembled Strain Relief Plates for Female Connectors

Item No. Suffix	733 Series, Pin Spacing: 2.5 mm Pole No.	713 Series, Pin Spacing: 3.5 mm Pole No.	734 Series, Pin Spacing: 3.5 / 3.81 mm Pole No.	231 / 721 Series, Pin Spacing: 5 / 5.08 mm Pole No.	231 / 721 Series, Pin Spacing: 7.5 / 7.62 mm Pole No.
.../032-000	2 ... 4	6 ... 12	2 ... 3	2 ... 3	2
.../033-000	5 ... 9	14 ... 20	4 ... 8	4 ... 5	3 ... 5
.../034-000	10 ... 12	22 ... 28	9 ... 12	6 ... 9	6 ... 7
.../035-000	-	30 ... 36	13 ... 16	10 ... 24	8 ... 16
.../036-000	-	-	17 ... max.	-	-
Item No. Suffix	2721 / 2231 / 721 Series and 2-Conductor Female Connectors, Pin Spacing: 5 / 5.08 mm Pole No.	2721 / 2231 / 721 Series and 2-Conductor Female Connectors, Pin Spacing: 7.5 / 7.62 mm Pole No.			
.../132-000	2	-			
.../133-000	3 ... 4	2 ... 3			
.../134-000	5 ... 7	4 ... 6			
.../135-000	8 ... 11	7 ... 9			
.../136-000	12 ... 16	10 ... 12			
.../137-000	17 ... 24	13 ... 16			

Sample order:

Angled female connector with strain relief plate, 7.62 mm pin spacing, 5-pole, orange: **732-125/026-000/033-000**

PCB Terminal Strips – Description and Installation –

Actuation with locking slide/lever/ push-button

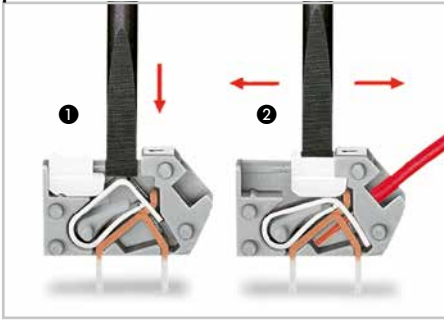

Conductor termination: **1** To momentarily open the clamping unit, use screwdriver and then insert stripped conductor. **2** To open clamping unit for extended period, move locking slide toward conductor entry hole. Then fully insert stripped conductor and move locking slide back to original position (also possible to perform with fingernail).

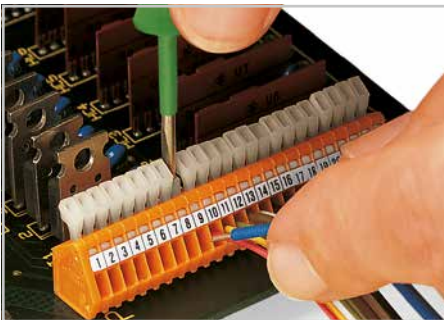

Inserting/removing conductor.

Actuation without locking slide/lever/ push-button

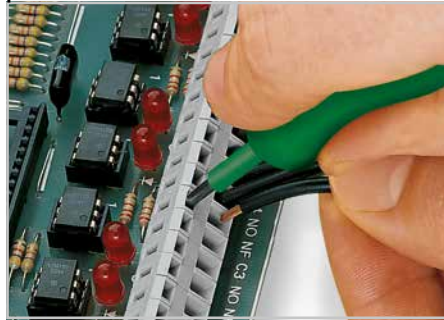

Inserting conductor via screwdriver (3.5 mm blade):
Conductor entry and clamp operation are parallel.

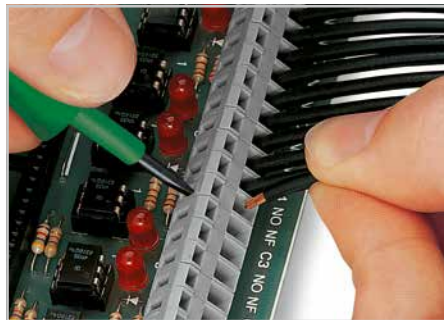

Inserting conductor via screwdriver (3.5 mm blade):
Conductor entry and clamp operation are perpendicular.

Testing

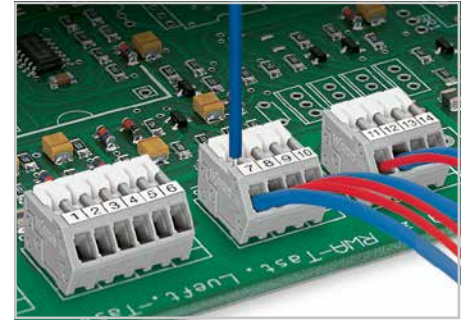

Inserting/removing conductor.

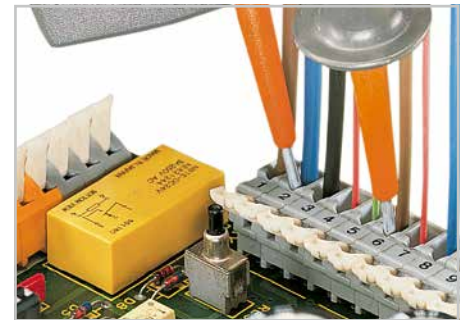

Testing with test probes.

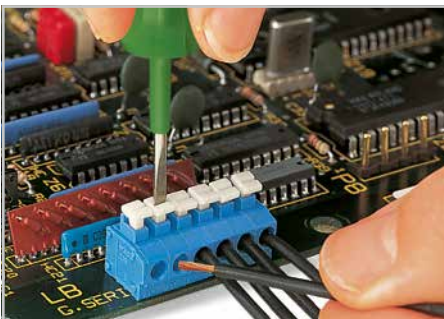

Inserting/removing fine-stranded conductor via
push-button.

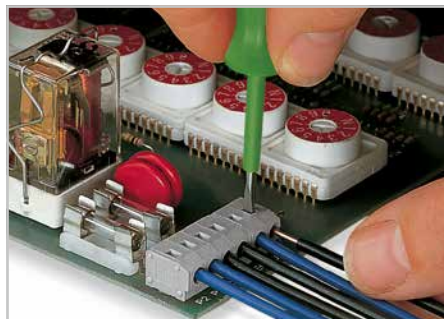

Removing conductor using a screwdriver – terminal strip
without push-buttons.



Inserting/removing conductor via finger-operated lever –
257 Series.
For terminal strips with finger-operated levers, see Full Line
Catalog.

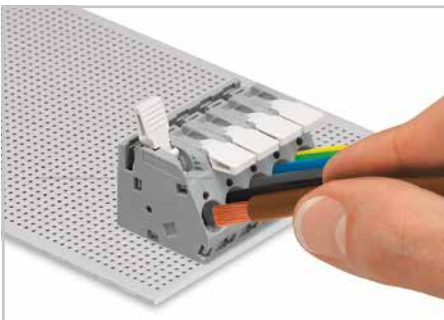

Inserting/removing conductor – 2706 and 2716 Series.

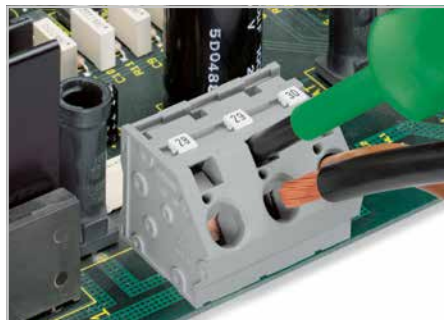

Inserting conductor via screwdriver (5.5 mm blade).

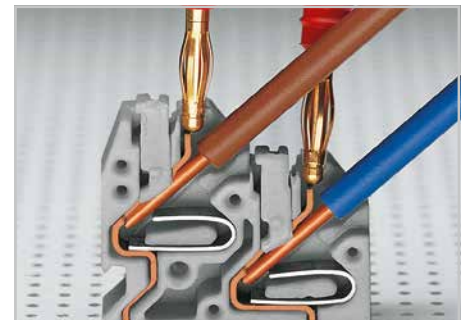

Testing with 2 mm Ø test plug.

Marking

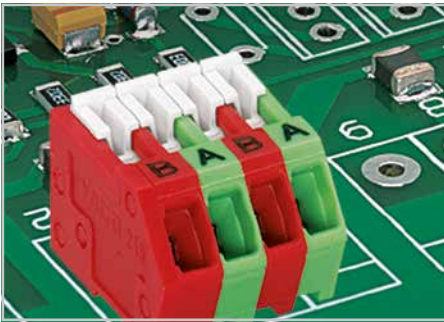

Factory direct marking.

Commoning

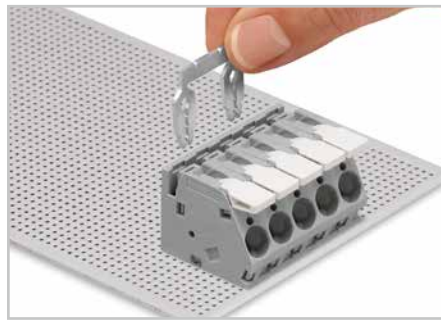

Insert the comb-style jumper bar.

Specialty functions



For terminal strips in other colors, please contact factory.



Marking via self-adhesive marking strips (above) or factory direct marking.

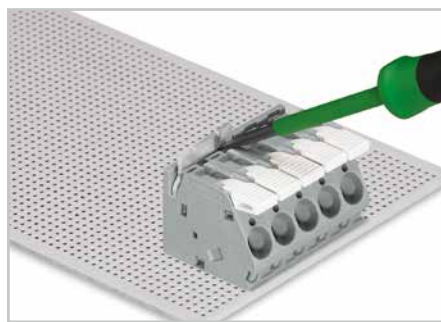

Push jumper bar down firmly using a screwdriver until it hits the backstop – 2706 and 2716 Series.

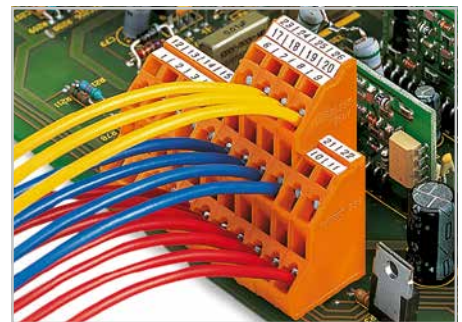

Space-saving triple-deck terminal strip

4

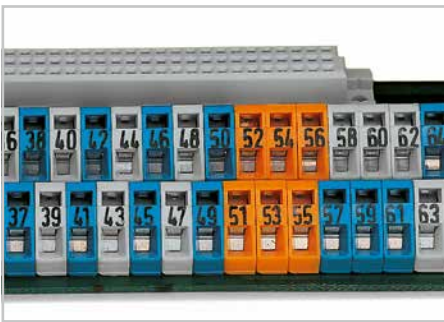

Mixed-color terminal strips with factory direct marking



Custom terminal strips are available upon request.

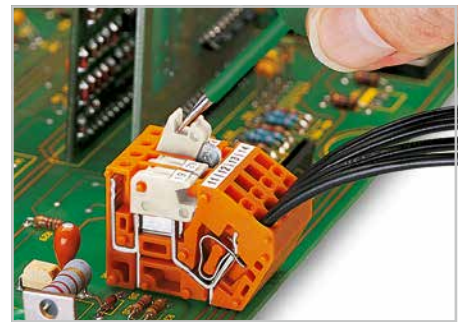

Opening knife disconnect.

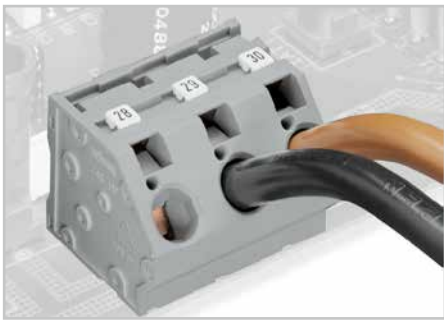

Marking via miniature WSB and WMB markers or factory direct marking – 745 Series.



Horizontal commoning:
Connection of adjacent terminals
Note: Interruption of horizontal commoning reduces spacing to the adjacent solder pins.

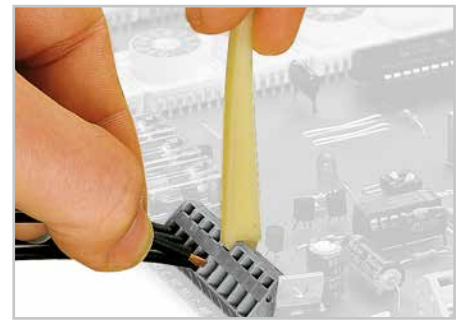

Inserting conductor via operating tool.

PCB Terminal Blocks

- Product Overview by Pin Spacing -

Colors available:

- green-yellow
- gray
- dark gray
- light gray
- white
- orange
- light green
- black
- blue
- red
- yellow
- brown
- green
- violet
- pink

Ex e II approval

Press-in technology

Through-hole reflow soldering

Surface-mount technology

Only available in this pin spacing

2.5 mm	
Item No.	Pack. Unit
233 Series, 2 ... 24 poles, 160 V / 6 A	
0.08 ... 0.5 mm ² / 28 ... 20 AWG	
233-102	600
233-124	80
233 Series, 2 ... 24 poles, 160 V / 6 A	
0.08 ... 0.5 mm ² / 28 ... 20 AWG	
233-202	600
233-224	80
234 Series, 2 ... 24 poles, 160 V / 6 A	
0.08 ... 0.5 mm ² / 28 ... 20 AWG	
234-202	600
234-224	80
250 Series, 2 ... 24 poles, 160 V / 4 A	
0.2 ... 0.5 mm ² / 24 ... 20 AWG	
250-402	720
250-424	60
250 Series, 2 ... 8 poles, 160 V / 4 A THR	
0.2 ... 0.5 mm ² / 24 ... 20 AWG	
250-402/350-604	720
250-408/350-604	220
218 Series, 2 ... 24 poles, 160 V / 6 A	
0.08 ... 0.5 mm ² / 28 ... 20 AWG	
218-102	1000
218-124	60
218 Series, 2 ... 7 poles, 160 V / 6 A THR	
0.08 ... 0.5 mm ² / 28 ... 20 AWG	
218-102/000-604	1000
218-107/000-604	240

2.54 mm	
Item No.	Pack. Unit
233 Series, 2 ... 24 poles, 160 V / 6 A	
0.08 ... 0.5 mm ² / 28 ... 20 AWG	
233-402	600
233-424	80
233 Series, 2 ... 24 poles, 160 V / 6 A	
0.08 ... 0.5 mm ² / 28 ... 20 AWG	
233-502	600
233-524	80
234 Series, 2 ... 24 poles, 160 V / 6 A	
0.08 ... 0.5 mm ² / 28 ... 20 AWG	
234-502	600
234-524	80
250 Series, 2 ... 24 poles, 160 V / 4 A	
0.2 ... 0.5 mm ² / 24 ... 20 AWG	
250-1402	720
250-1424	60
218 Series, 2 ... 24 poles, 160 V / 6 A	
0.08 ... 0.5 mm ² / 28 ... 20 AWG	
218-502	1000
218-524	60
218 Series, 2 ... 7 poles, 160 V / 6 A THR	
0.08 ... 0.5 mm ² / 28 ... 20 AWG	
218-502/000-604	1000
218-507/000-604	240

3.5 mm	
Item No.	Pack. Unit
739 Series, 2 ... 12 poles, 160 V / 17.5 A	
0.08 ... 1.5 mm ² / 28 ... 14 AWG	
739-302	560
739-312	100
805 Series, 2 ... 24 poles, 320 V / 17.5 A	
0.2 ... 1.5 mm ² / 24 ... 16 AWG	
805-102	580
805-124	40
805 Series, 2 ... 8 poles, 320 V / 17.5 A THR	
0.2 ... 1.5 mm ² / 24 ... 16 AWG	
805-302/200-604	600
805-308/200-604	160
250 Series, 2 ... 24 poles, 160 V / 8 A	
0.2 ... 1.5 mm ² / 24 ... 16 AWG	
250-102	560
250-124	40
250 Series, 2 ... 8 poles, 320 V / 8 A THR	
0.2 ... 1.5 mm ² / 24 ... 16 AWG	
250-202/353-604	560
250-208/353-604	160
739 Series, 3 ... 12 poles, 160 V / 4 A	
0.08 ... 1.5 mm ² / 28 ... 14 AWG	
739-303/100-000	400
739-312/100-000	100
744 Series, 2 ... 10 poles, 320 V / 2 A	
0.5 ... 1.5 mm ² / 20 ... 16 AWG "s"	
744-292	1000
744-210	200
251 Series, 2 ... 7 poles, 320 V / 2 A (6 A)	
0.5 ... 1.5 mm ² / 20 ... 16 AWG "s"	
251-102	600
251-107	180

3.81 mm	
Item No.	Pack. Unit
739 Series, 2 ... 12 poles, 320 V / 17.5 A	
0.08 ... 1.5 mm ² / 28 ... 14 AWG	
739-332	520
739-342	100
235 Series, 2 ... 48 poles, 320 V / 17.5 A	
0.5 ... 1.5 mm ² / 20 ... 16 AWG	
235-101	520
235-148	20
235 Series, 2 ... 48 poles, 320 V / 17.5 A	
0.5 ... 1.5 mm ² / 20 ... 16 AWG "s"	
235-101/330-000	520
235-148/330-000	20
735 Series, 2 ... 7 poles, 320 V / 10 A	
0.5 ... 1.5 mm ² / 20 ... 16 AWG "s"	
735-122	660
735-127	180
739 Series, 3 ... 12 poles, 160 V / 4 A	
0.08 ... 1.5 mm ² / 28 ... 14 AWG	
739-333/100-000	360
739-342/100-000	100

PCB Terminal Blocks

- Product Overview by Pin Spacing -













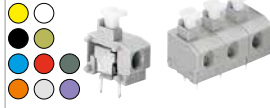



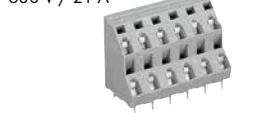





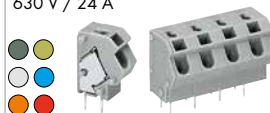

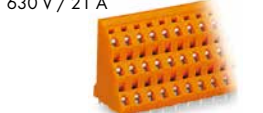











5 mm			
Item No.	Pack. Unit	Item No.	Pack. Unit
236 Series , 2 ... 48 poles, 320 V / 24 A		236 Series , 2 ... 6 poles, 320 V / 24 A	
0.08 ... 2.5 mm ² / 28 ... 12 AWG		0.08 ... 2.5 mm ² / 28 ... 12 AWG	
○ 236-101 420		● 236-402/334-604 420	
○ 236-148 20		● 236-406/334-604 140	
736 Series , 2 x 2 ... 24 x 2 poles, 320 V / 21 A		740 Series , 2 ... 24 poles, 320 V / 16 A	
0.08 ... 2.5 mm ² / 28 ... 12 AWG		0.08 ... 2.5 mm ² / 28 ... 12 AWG	
○ 736-102 161		○ 740-102 460	
○ 736-124 14		○ 740-124 40	
737 Series , 2 x 3 ... 24 x 3 poles, 320 V / 21 A		253 Series , 2 ... 16 poles, 320 V / 17.5 A	
0.08 ... 2.5 mm ² / 28 ... 12 AWG		0.5 ... 1.5 mm ² / 20 ... 16 AWG "s"	
○ 737-102 92		○ 253-102 400	
○ 737-124 8		○ 253-116 40	
738 Series , 2 x 4 ... 24 x 4 poles, 320 V / 18 A		250 Series , 2 ... 16 poles, 320 V / 17.5 A	
0.08 ... 2.5 mm ² / 28 ... 12 AWG		0.5 ... 1.5 mm ² / 20 ... 16 AWG	
○ 738-102 72		○ 250-502 400	
○ 738-124 6		○ 250-516 40	
255 Series , 2 ... 48 poles, 320 V / 24 A		250 Series , 2 ... 24 poles, 320 V / 10 A	
0.08 ... 2.5 mm ² / 28 ... 12 AWG		0.5 ... 1.5 mm ² / 20 ... 16 AWG	
○ 255-401 400		○ 250-702 264	
○ 255-448 20		○ 250-724 24	
256 Series , 2 ... 48 poles, 320 V / 24 A		816 Series , 2 ... 12 poles, 320 V / 14 A	
0.08 ... 2.5 mm ² / 28 ... 12 AWG		2 x 0.2 ... 1.5 mm ² / 2 x 24 ... 16 AWG	
○ 256-401 400		○ 816-102 400	
○ 256-448 20		○ 816-112 60	
257 Series , 2 ... 48 poles, 320 V / 24 A		254 Series , 2 ... 48 poles, 320 V / 24 A	
0.08 ... 2.5 mm ² / 28 ... 12 AWG		0.5 ... 2.5 mm ² / 20 ... 12 AWG "s"	
○ 257-401 400		○ 254-451 420	
○ 257-448 20		○ 254-498 20	
739 Series , 2 ... 24 poles, 320 V / 24 A		804 Series , 2 ... 16 poles, 320 V / 24 A	
0.08 ... 2.5 mm ² / 28 ... 12 AWG		0.25 ... 2.5 mm ² / 20 ... 12 AWG	
○ 739-102 400		○ 804-102 420	
○ 739-124 20		○ 804-116 60	
742 Series , 1 ... 3 conductors, 320 V / 16 A		742 Series , 1 ... 3 conductors, 320 V / 16 A	
0.08 ... 2.5 mm ² / 28 ... 12 AWG		0.08 ... 2.5 mm ² / 28 ... 12 AWG	
○ 742-101 384		○ 742-153 100	
742 Series , 1/2-conductor, 320 V / 16 A		742 Series , 1 ... 3 conductors, 320 V / 15 A	
0.08 ... 2.5 mm ² / 28 ... 12 AWG		0.08 ... 2.5 mm ² / 28 ... 12 AWG	
○ 742-121 300		○ 742-111 300	
		○ 742-163 100	
741 Series , 2 ... 16 poles, 320 V / 16 A		741 Series , 2 ... 16 poles, 320 V / 16 A	
0.08 ... 2.5 mm ² / 28 ... 12 AWG		0.08 ... 2.5 mm ² / 28 ... 12 AWG	
○ 741-102 400		○ 741-116 40	
735 Series , 2 ... 7 poles, 320 V / 10 A		735 Series , 2 ... 7 poles, 320 V / 10 A	
0.5 ... 1.5 mm ² / 20 ... 16 AWG "s"		0.5 ... 1.5 mm ² / 20 ... 16 AWG "s"	
○ 735-302 500		○ 735-307 140	
235 Series , 2 ... 48 poles, 320 V / 24 A		235 Series , 2 ... 48 poles, 320 V / 24 A	
0.5 ... 2.5 mm ² / 20 ... 14 AWG "s"		0.5 ... 2.5 mm ² / 20 ... 14 AWG "s"	
○ 235-402 421		○ 235-448 20	
745 Series , 2 ... 12 poles, 320 V / 32 A		745 Series , 2 ... 12 poles, 320 V / 32 A	
0.08 ... 4 mm ² / 28 ... 12 AWG		0.08 ... 4 mm ² / 28 ... 12 AWG	
○ 745-3102 276		○ 745-3112 48	
739 Series , 2 ... 24 poles, 320 V / 24 A		739 Series , 2 ... 24 poles, 320 V / 24 A	
0.08 ... 2.5 mm ² / 28 ... 12 AWG		0.08 ... 2.5 mm ² / 28 ... 12 AWG	
○ 739-152 400		○ 739-174 20	
739 Series , 3 ... 12 poles, 320 V / 8 A		739 Series , 3 ... 12 poles, 320 V / 8 A	
0.08 ... 1.5 mm ² / 28 ... 14 AWG		0.08 ... 1.5 mm ² / 28 ... 14 AWG	
○ 739-153/100-000 360		○ 739-162/100-000 100	

5.08 mm			
Item No.	Pack. Unit	Item No.	Pack. Unit
236 Series , 2 ... 48 poles, 320 V / 24 A		742 Series , 1 ... 3 conductors, 320 V / 16 A	
0.08 ... 2.5 mm ² / 28 ... 12 AWG		0.08 ... 2.5 mm ² / 28 ... 12 AWG	
○ 236-101 420		○ 742-106 384	
○ 236-148 20		○ 742-158 100	
736 Series , 2 x 2 ... 24 x 2 poles, 320 V / 21 A		742 Series , 1/2-conductor, 320 V / 16 A	
0.08 ... 2.5 mm ² / 28 ... 12 AWG		0.08 ... 2.5 mm ² / 28 ... 12 AWG	
○ 736-302 161		○ 742-126 300	
○ 736-324 14		○ 742-176 200	
737 Series , 2 x 3 ... 24 x 3 poles, 320 V / 21 A		742 Series , 1 ... 3 conductors, 320 V / 15 A	
0.08 ... 2.5 mm ² / 28 ... 12 AWG		0.08 ... 2.5 mm ² / 28 ... 12 AWG	
○ 737-302 92		○ 742-116 300	
○ 737-324 8		○ 742-168 100	
738 Series , 2 x 4 ... 24 x 4 poles, 320 V / 18 A		741 Series , 2 ... 16 poles, 320 V / 16 A	
0.08 ... 2.5 mm ² / 28 ... 12 AWG		0.08 ... 2.5 mm ² / 28 ... 12 AWG	
○ 738-302 72		○ 741-202 400	
○ 738-324 6		○ 741-216 40	
255 Series , 2 ... 48 poles, 320 V / 24 A		255 Series , 2 ... 48 poles, 320 V / 24 A	
0.08 ... 2.5 mm ² / 28 ... 12 AWG		0.08 ... 2.5 mm ² / 28 ... 12 AWG	
○ 255-401 400		○ 255-448 20	
256 Series , 2 ... 48 poles, 320 V / 24 A		235 Series , 2 ... 48 poles, 320 V / 24 A	
0.08 ... 2.5 mm ² / 28 ... 12 AWG		0.5 ... 2.5 mm ² / 20 ... 14 AWG "s"	
○ 256-401 400		○ 235-401 420	
○ 256-448 20		○ 235-448 20	
257 Series , 2 ... 48 poles, 320 V / 24 A		254 Series , 2 ... 48 poles, 320 V / 24 A	
0.08 ... 2.5 mm ² / 28 ... 12 AWG		0.5 ... 2.5 mm ² / 20 ... 12 AWG "s"	
○ 257-401 400		○ 254-451 420	
○ 257-448 20		○ 254-498 20	
739 Series , 2 ... 24 poles, 320 V / 24 A		739 Series , 3 ... 12 poles, 320 V / 8 A	
0.08 ... 2.5 mm ² / 28 ... 12 AWG		0.08 ... 1.5 mm ² / 28 ... 14 AWG	
○ 739-152 400		○ 739-153/100-000 360	
○ 739-174 20		○ 739-162/100-000 100	

4

PCB Terminal Blocks

- Product Overview by Pin Spacing -

7.5 mm				7.62 mm			
Item No.	Pack. Unit	Item No.	Pack. Unit	Item No.	Pack. Unit	Item No.	Pack. Unit
236 Series , 2 ... 24 poles, 630 V / 24 A		235 Series , 2 ... 24 poles, 630 V / 17.5 A		745 Series , 2 ... 12 poles, 630 V / 32 A		236 Series , 2 ... 24 poles, 630 V / 24 A	
							
0.08 ... 2.5 mm ² / 28 ... 12 AWG		0.5 ... 1.5 mm ² / 20 ... 14 AWG		0.08 ... 4 mm ² / 28 ... 12 AWG		0.08 ... 2.5 mm ² / 28 ... 12 AWG	
○ 236-201 280		○ 235-501/331-000 280		○ 745-3152 228		○ 236-201 280	
○ 236-224 20		○ 235-524/331-000 20		○ 745-3162 36		○ 236-224 20	
736 Series , 2 x 2 ... 16 x 2 poles, 630 V / 21 A		235 Series , 2 ... 24 poles, 630 V / 24 A		745 Series , 2 ... 12 poles, 630 V / 32 A		736 Series , 2 x 2 ... 16 x 2 poles, 630 V / 21 A	
							
0.08 ... 2.5 mm ² / 28 ... 12 AWG		0.5 ... 2.5 mm ² / 20 ... 14 AWG "s"		0.08 ... 4 mm ² / 28 ... 12 AWG		0.08 ... 2.5 mm ² / 28 ... 12 AWG	
○ 736-502 133		○ 235-501 280		○ 745-152 180		○ 736-602 133	
○ 736-516 14		○ 235-524 20		○ 745-162 30		○ 736-616 14	
737 Series , 2 x 3 ... 16 x 3 poles, 630 V / 21 A		254 Series , 2 ... 24 poles, 630 V / 24 A		745 Series , 2 ... 12 poles, 630 V / 41 A		737 Series , 2 x 3 ... 16 x 3 poles, 630 V / 21 A	
							
0.08 ... 2.5 mm ² / 28 ... 12 AWG		0.5 ... 2.5 mm ² / 20 ... 12 AWG "s"		0.2 ... 6 mm ² / 24 ... 10 AWG		0.08 ... 2.5 mm ² / 28 ... 12 AWG	
○ 737-502 76		○ 254-551 280		○ 745-302 128		○ 737-602 76	
○ 737-516 8		○ 254-574 20		○ 745-312 16		○ 737-616 8	
255 Series , 2 ... 24 poles, 630 V / 24 A		741 Series , 2 ... 10 poles, 630 V / 16 A		2706 Series , 2 ... 12 poles, 630 V / 41 A		255 Series , 2 ... 24 poles, 630 V / 24 A	
							
0.08 ... 2.5 mm ² / 28 ... 12 AWG		0.08 ... 2.5 mm ² / 28 ... 12 AWG		0.5 ... 6 mm ² / 20 ... 10 AWG		0.08 ... 2.5 mm ² / 28 ... 12 AWG	
○ 255-501 280		○ 741-302 340		○ 2706-102 85		○ 255-501 280	
○ 255-524 20		○ 741-310 60		○ 2706-112 15		○ 255-524 20	
256 Series , 2 ... 24 poles, 320 V / 24 A		250 Series , 2 ... 12 poles, 630 V / 17.5 A		2706 Series , 2 ... 12 poles, 630 V / 41 A		256 Series , 2 ... 24 poles, 320 V / 24 A	
							
0.08 ... 2.5 mm ² / 28 ... 12 AWG		0.5 ... 1.5 mm ² / 20 ... 16 AWG		0.5 ... 6 mm ² / 20 ... 10 AWG		0.08 ... 2.5 mm ² / 28 ... 12 AWG	
○ 256-501 280		○ 250-602 340		○ 2706-152 85		○ 256-501 280	
○ 256-524 20		○ 250-612 40		○ 2706-162 15		○ 256-524 20	
257 Series , 2 ... 24 poles, 630 V / 24 A		804 Series , 2 ... 12 poles, 320 V / 24 A		746 Series , 2 ... 12 poles, 1,000 V / 50 A		257 Series , 2 ... 24 poles, 630 V / 24 A	
							
0.08 ... 2.5 mm ² / 28 ... 12 AWG		0.25 ... 2.5 mm ² / 20 ... 12 AWG		2 x 0.5 ... 10 mm ² / 2 x 20 ... 8 AWG		0.08 ... 2.5 mm ² / 28 ... 12 AWG	
○ 257-501 280		○ 804-302 340		○ 746-2302 60		○ 257-501 280	
○ 257-524 20		○ 804-312 40		○ 746-2312 16		○ 257-524 20	
739 Series , 2 ... 12 poles, 630 V / 24 A						739 Series , 2 ... 12 poles, 630 V / 24 A	
							
0.08 ... 2.5 mm ² / 28 ... 12 AWG						0.08 ... 2.5 mm ² / 28 ... 12 AWG	
○ 739-202 340						○ 739-232 340	
○ 739-212 40						○ 739-242 40	
739 Series , 3 ... 12 poles, 630 V / 8 A						739 Series , 3 ... 12 poles, 630 V / 8 A	
							
0.08 ... 2.5 mm ² / 28 ... 12 AWG						0.08 ... 2.5 mm ² / 28 ... 12 AWG	
○ 739-203/100-000 220						○ 739-233/100-000 220	
○ 739-212/100-000 40						○ 739-242/100-000 40	

PCB Terminal Blocks

- Product Overview by Pin Spacing -



























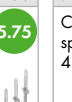

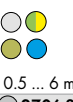

10 mm			
Item No.	Pack. Unit	Item No.	Pack. Unit
236 Series , 2 ... 24 poles, 1,000 V / 10 A		235 Series , 2 ... 24 poles, 1,000 V / 17.5 A	
0.08 ... 2.5 mm ² / 28 ... 12 AWG		0.5 ... 1.5 mm ² / 20 ... 14 AWG	
○ 236-301 200		○ 235-801/331-000 220	
○ 236-324 20		○ 235-824/331-000 20	
736 Series , 2 x 2 ... 12 x 2 poles, 1,000 V / 21 A		235 Series , 2 ... 24 poles, 1,000 V / 24 A	
0.08 ... 2.5 mm ² / 28 ... 12 AWG		0.5 ... 2.5 mm ² / 20 ... 14 AWG "s"	
○ 736-702 112		○ 235-801 220	
○ 736-712 14		○ 235-824 20	
737 Series , 2 x 3 ... 12 x 3 poles, 1,000 V / 21 A		254 Series , 2 ... 24 poles, 1,000 V / 24 A	
0.08 ... 2.5 mm ² / 28 ... 12 AWG		0.5 ... 2.5 mm ² / 20 ... 12 AWG "s"	
○ 737-702 64		○ 254-651 280	
○ 737-712 8		○ 254-674 20	
255 Series , 2 ... 24 poles, 1,000 V / 24 A		741 Series , 2 ... 8 poles, 1,000 V / 16 A	
0.08 ... 2.5 mm ² / 28 ... 12 AWG		0.08 ... 2.5 mm ² / 28 ... 12 AWG	
○ 255-601 200		○ 741-502 280	
○ 255-624 20		○ 741-508 60	
256 Series , 2 ... 24 poles, 630 V / 24 A		745 Series , 2 ... 5 poles, 320 V / 76 A	
0.08 ... 2.5 mm ² / 28 ... 12 AWG		0.2 ... 16 mm ² / 24 ... 6 AWG	
○ 256-601 200		○ 745-502/006-000 48	
○ 256-624 20		○ 745-505/006-000 20	
257 Series , 2 ... 24 poles, 1,000 V / 24 A		2706 Series , 2 ... 12 poles, 1,000 V / 41 A	
0.08 ... 2.5 mm ² / 28 ... 12 AWG		0.5 ... 6 mm ² / 20 ... 10 AWG	
○ 257-601 200		○ 2706-202 70	
○ 257-624 20		○ 2706-212 10	
739 Series , 2 ... 12 poles, 630 V / 24 A		2706 Series , 2 ... 12 poles, 1,000 V / 41 A	
0.08 ... 2.5 mm ² / 28 ... 12 AWG		0.5 ... 6 mm ² / 20 ... 10 AWG	
○ 739-3202 280		○ 2706-252 70	
○ 739-3212 40		○ 2706-262 10	
745 Series , 2 ... 12 poles, 1,000 V / 32 A		2716 Series , 2 ... 8 poles, 320 V / 75 A	
0.08 ... 4 mm ² / 28 ... 12 AWG		1.5 ... 16 mm ² / 16 ... 6 AWG	
○ 745-3202 192		○ 2716-102 65	
○ 745-3212 24		○ 2716-108 15	
		2716 Series , 2 ... 8 poles, 1,000 V / 76 A	
		1.5 ... 16 mm ² / 16 ... 6 AWG	
		○ 2716-152 52	
		○ 2716-158 12	

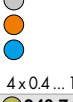
10.16 mm			
Item No.	Pack. Unit	Item No.	Pack. Unit
236 Series , 2 ... 24 poles, 1,000 V / 10 A		235 Series , 2 ... 24 poles, 1,000 V / 17.5 A	
0.08 ... 2.5 mm ² / 28 ... 12 AWG		0.5 ... 1.5 mm ² / 20 ... 14 AWG	
○ 236-301 200		○ 235-801/331-000 220	
○ 236-324 20		○ 235-824/331-000 20	
736 Series , 2 x 2 ... 12 x 2 poles, 1,000 V / 21 A		235 Series , 2 ... 24 poles, 1,000 V / 24 A	
0.08 ... 2.5 mm ² / 28 ... 12 AWG		0.5 ... 2.5 mm ² / 20 ... 14 AWG "s"	
○ 736-802 112		○ 235-801 220	
○ 736-812 14		○ 235-824 20	
737 Series , 2 x 3 ... 12 x 3 poles, 1,000 V / 21 A		254 Series , 2 ... 24 poles, 1,000 V / 24 A	
0.08 ... 2.5 mm ² / 28 ... 12 AWG		0.5 ... 2.5 mm ² / 20 ... 12 AWG "s"	
○ 737-802 64		○ 254-651 280	
○ 737-812 8		○ 254-674 20	
255 Series , 2 ... 24 poles, 1,000 V / 24 A		741 Series , 2 ... 8 poles, 1,000 V / 16 A	
0.08 ... 2.5 mm ² / 28 ... 12 AWG		0.08 ... 2.5 mm ² / 28 ... 12 AWG	
○ 255-601 200		○ 741-602 280	
○ 255-624 20		○ 741-608 60	
256 Series , 2 ... 24 poles, 630 V / 24 A			
0.08 ... 2.5 mm ² / 28 ... 12 AWG			
○ 256-601 200			
○ 256-624 20			
257 Series , 2 ... 24 poles, 1,000 V / 24 A			
0.08 ... 2.5 mm ² / 28 ... 12 AWG			
○ 257-601 200			
○ 257-624 20			

4















PCB Terminal Blocks

- Product Overview by Pin Spacing -

12.5 mm		15 mm		20 mm		Pluggable PCB Terminal Blocks		Comb-Style Jumper Bars	
Item No.	Pack. Unit	Item No.	Pack. Unit	Item No.	Pack. Unit	Item No.	Pack. Unit	Item No.	Pack. Unit
745 Series, 2 ... 12 poles, 1,000 V / 32 A	 168	745 Series, 2 ... 12 poles, 1,000 V / 41 A	 64	745 Series, 2 ... 5 poles, 1,000 V / 76 A	 8	252 Series, 2 ... 10 poles, 320 V / 2 A	 600	Comb-style jumper bar, 5 mm pin spacing, for 745 Series - 4 mm ²	745-181 250
 0.08 ... 4 mm ² / 28 ... 12 AWG	745-3252 168	 0.2 ... 6 mm ² / 24 ... 10 AWG	745-1452 64	 0.2 ... 16 mm ² / 24 ... 6 AWG	745-652/006-000 32	 2x0.4...0.8mm \varnothing / 2x26...20AWG"s	745-110 150		745-185 200
745-3262 12		745 Series, 2 ... 5 poles, 1,000 V / 76 A	 8			252 Series, 2 ... 10 poles, 320 V / 2 A	 600	Comb-style jumper bar, 7.5 mm pin spacing, for 745 Series - 4 mm ²	745-191 250
 0.2 ... 6 mm ² / 24 ... 10 AWG	745-1402 80	 0.2 ... 16 mm ² / 24 ... 6 AWG	745-602/006-000 36			 2x0.4...0.8mm \varnothing / 2x26...20AWG"s	745-160 150		745-195 200
745-1412 8		2716 Series, 2 ... 8 poles, 1,000 V / 76 A	 10			243 Series, 2 ... 8 poles, 320 V / 6 A	 50	Comb-style jumper bar, 10 mm pin spacing, for 745 Series - 4 mm ²	745-281 250
2706 Series, 2 ... 12 poles, 1,000 V / 41 A	 5	 1.5 ... 16 mm ² / 16 ... 6 AWG	2716-202 50			 4 x 0.4 ... 1.0 mm \varnothing / 4 x 24 ... 18 AWG	243-742 50		745-285 200
 0.5 ... 6 mm ² / 20 ... 10 AWG	2706-302 65	2716 Series, 2 ... 8 poles, 1,000 V / 76 A	 8			 806 Series, 2 ... 12 poles, 320 V / 10 A	 400	Comb-style jumper bar, 7.5 mm pin spacing, for 745 Series - 6 mm ² and 2706 Series	745-281 250
2706-312 5		 1.5 ... 16 mm ² / 16 ... 6 AWG	2716-252 40			 2 x 0.2 ... 1.5 mm \varnothing / 2 x 24 ... 16 AWG	806-102 400		745-381 250
		2716-258 8				806-112 60		Comb-style jumper bar, 10 mm pin spacing, for 745 Series - 6 mm ² and 2706 Series	745-385 200
									745-391 250
								Comb-style jumper bar, 10 mm pin spacing, for 745 Series - 16 mm ² and 2716 Series	745-395 200
									745-582 400
								Comb-style jumper bar, 15 mm pin spacing, for 745 Series - 16 mm ² and 2716 Series	745-585 200
									745-631 200
								Comb-style jumper bar, 20 mm pin spacing, for 745 Series - 16 mm ² and 2716 Series	745-635 200
									745-681 300
									745-685 200



SMD PCB Terminal Blocks

- Product Overview by Pin Spacing -





3 mm		4 mm		6 mm		8 mm			
Item No.	Pack. Unit	Item No.	Pack. Unit	Item No.	Pack. Unit	Item No.	Pack. Unit		
2059 Series, 1 ... 3 poles, 160 V / 3 A	SMT	2060 Series, 1 ... 3 poles Solder pin length: 2.4 mm 160 V / 9 A	THR	2061 Series, 1 ... 3 poles Solder pin length: 2.4 mm 320 V / 17.5 A	THR	2061 Series, 1 ... 3 poles Solder pin length: 1.5 mm 320 V / 17.5 A	THR	2060 Series, 2 poles, 630 V / 9 A	SMT
									
0.14 ... 0.5 mm ² / 26 ... 20 AWG "s"		0.2 ... 0.75 mm ² / 24 ... 18 AWG		0.5 ... 1.5 mm ² / 20 ... 16 AWG		0.5 ... 1.5 mm ² / 20 ... 16 AWG		0.2 ... 0.75 mm ² / 24 ... 18 AWG	
○ 2059-301/998-403 31800		○ 2060-1451/998-404 10800		○ 2061-1601/998-404 5760		○ 2061-1641/998-404 5760		○ 2060-852/998-404 6750	
○ 2059-303/998-403 21000		○ 2060-1453/998-404 4950		○ 2061-1603/998-404 2880		○ 2061-1643/998-404 2880			
		2060 Series, 1 ... 3 poles Solder pin length: 2.4 mm 160 V / 9 A	THR	2061 Series, 1 ... 3 poles Solder pin length: 2.4 mm 320 V / 17.5 A	THR	2061 Series, 1 ... 3 poles Solder pin length: 1.5 mm 320 V / 17.5 A	THR	2060 Series, 2 poles Solder pin length: 2.4 mm 630 V / 9 A	THR
									
		0.2 ... 0.75 mm ² / 24 ... 18 AWG		0.5 ... 1.5 mm ² / 20 ... 16 AWG		0.5 ... 1.5 mm ² / 20 ... 16 AWG		0.2 ... 0.75 mm ² / 24 ... 18 AWG	
		● 2060-1471/998-404 10800		● 2061-1621/998-404 5760		● 2061-1661/998-404 5760		● 2060-1872/998-404 4590	
		● 2060-1473/998-404 4950		● 2061-1623/998-404 2880		● 2061-1663/998-404 2880			
		2060 Series, 1 ... 3 poles, 160 V / 9 A	SMT	2061 Series, 1 ... 3 poles, 320 V / 17.5 A	SMT			2060 Series, 2 poles Solder pin length: 2.4 mm 630 V / 9 A	THR
									
		0.2 ... 0.75 mm ² / 24 ... 18 AWG		0.5 ... 1.5 mm ² / 20 ... 16 AWG				0.2 ... 0.75 mm ² / 24 ... 18 AWG	
		○ 2060-451/998-404 13500		○ 2061-601/998-404 8100				○ 2060-1852/998-404 4590	
		○ 2060-453/998-404 6750		○ 2061-603/998-404 4050					
		2060 Series, 1 ... 3 poles, 160 V / 9 A	SMT	2061 Series, 1 ... 3 poles, 320 V / 17.5 A	SMT				
									
		0.2 ... 0.75 mm ² / 24 ... 18 AWG		0.5 ... 1.5 mm ² / 20 ... 16 AWG					
		● 2060-471/998-404 13500		● 2061-621/998-404 8100					
		● 2060-473/998-404 6750		● 2061-623/998-404 4050					

4

Board-to-Board Links for SMD PCB Terminal Blocks with Push-Buttons

	4 mm pin spacing, 1 ... 4 poles		8 mm pin spacing, 2 poles
			
	2060-951/028-000 1500		2060-962/028-000 375
	2060-954/028-000 250		

Operating Tools

for 2059 Series	for 2060 Series	for 2061 Series
		
206-859 5	206-860 5	206-861 5
insulated, for 2059 Series	insulated, for 2060 Series	insulated, for 2061 Series
		
2059-189 600	2060-189 300	2061-189 300



WINSTA® – The Pluggable Connection System

By interconnecting all electrical components, WINSTA® endows modern buildings with high levels of flexibility and durability that readily satisfy stringent norms and standards.

The WINSTA® system offers connections for virtually any building requirement from power supply to bus lines. Each unique WINSTA® model has been specifically developed to satisfy pole requirements, installation restrictions and current-carrying capacities.

Each model line contains both individual components (e.g., plugs, sockets, h-distribution connectors, T-distribution connectors, distribution boxes) and cable assemblies in standardized construction industry lengths.



Installation Examples:

Built-in ceiling lights

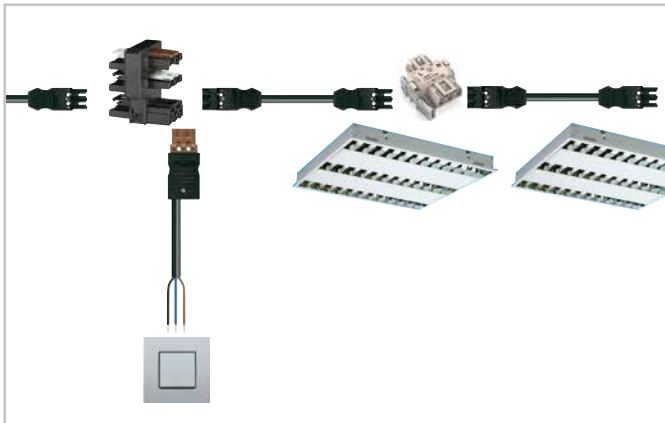

Wall sockets

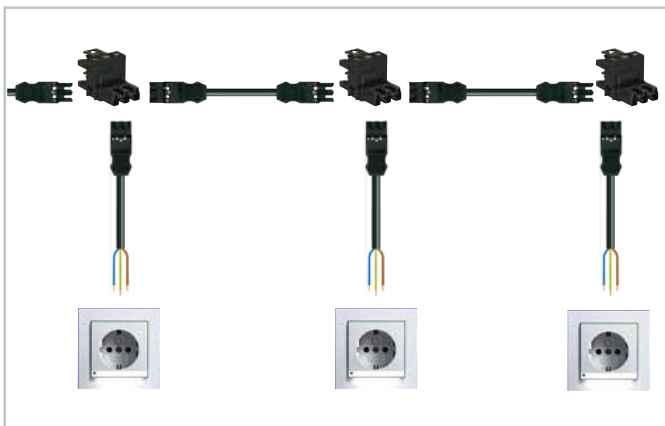

Floor tanks



WINSTA® Project Engineering

WAGO offers consulting and project planning services to help devise the best possible solution for your project. Our experienced team of professionals will gladly help you implement your project with our products.

5

Bid forms at
www.wago.com



WINSTA® – The Pluggable Connection System

WINSTA® MINI

For Space-Restricted Applications

- Sensors (switches, push-buttons, window contacts, pressure switches, temperature sensors, etc.)
- Actuators (control valves, magnetic valves, servo motors, blinds/sun protection, etc.)
- Protection class II for halogen lamps and luminaires
- Control signals
- 1.5 mm² (16 AWG), 250 V, 16 A

2 ... 5 poles
890 and 891 Series



WINSTA® MIDI

For Maximum Possibilities

- General building installation, ideal for modern buildings
- Standard lighting fixtures and safety lights
- Tradeshow and shop installation
- Motor homes
- Lab work stations
- Rolling stock
- Shipbuilding
- 4 mm² (12 AWG), 250/400 V, 25 A

2 ... 5 poles
770 and 771 Series

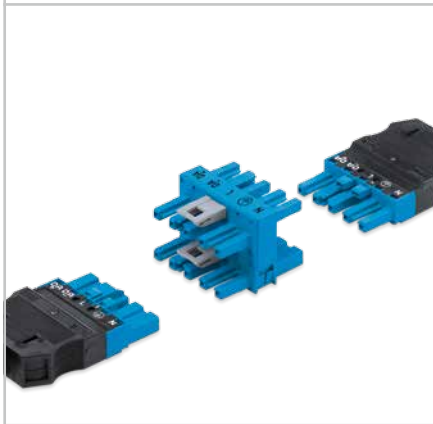

WINSTA® MAXI

For High-Current Applications

- Power supply via 6 mm² (10 AWG) cable for extended cable runs
- 32 A power supply in distribution boxes for high energy requirements
- 6 mm² (10 AWG), 250/400 V, 35 A

5 poles
831 Series



WINSTA® MINI special

For Specialty Applications

2 ... 5 poles
890 and 891 Series



WINSTA® MIDI special

For Specialty Applications

2 ... 5 poles
770 and 771 Series

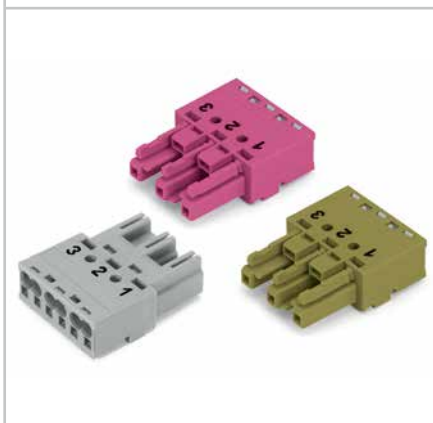

WINSTA® Boxes

Distribution Boxes

899 Series



WINSTA® KNX

For the Standardized Bus

- KNX/EIB
- Control signals
- 0.8 mm Ø, 50 V, 3 A

2 poles
893 and 894 Series

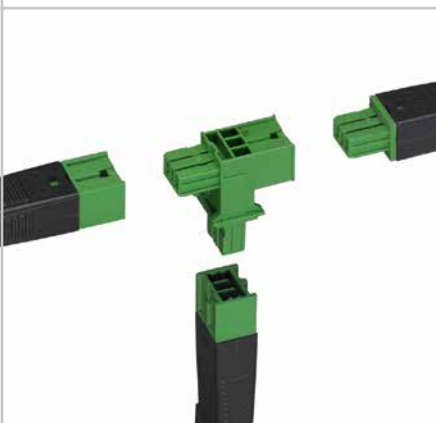
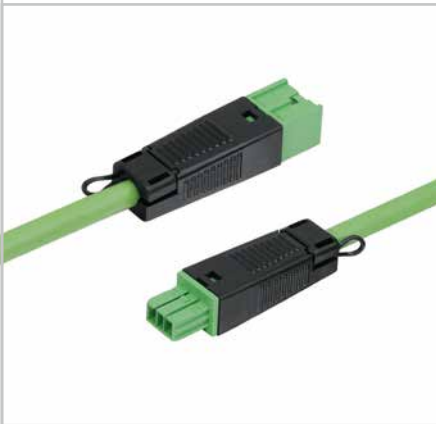

WINSTA® IDC

For Maximum Flexibility

- Supply and tap off is possible at any time and at any location along the flat cable. No cutting, no stripping, no dismantling – very user-friendly
- A 120° rotation is all that is required to connect the flat cable
- Space-efficient across the flat cable through longitudinal tap off
- 2.5/4 mm² (14/12 AWG), 400 V, 25 A
- 10 mm² (8 AWG), 690 V, 57 A
- 16 mm² (6 AWG), 690 V, 76 A

2, 3, 5 and 7 poles
772, 893, 895, 896 and 897 Series



WINSTA® RD

For Round Conduits and Ducts

- Outside diameter of 17.5 mm for applications in electrical conduits with an inner diameter > 18 mm
- Prefabricated houses
- Recessed luminaires
- Wall and ceiling cutouts



3 and 4 poles
774 Series



WINSTA® MINI

Sockets and Plugs



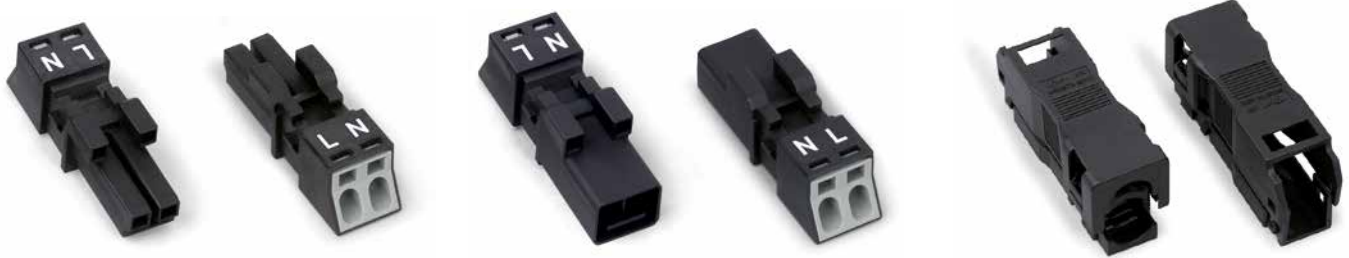

890 Series

0.25 ... 1.5 mm ² 250 V/4 kV/3 ① 400 V/6 kV/3 ②③ I _N 16 A ①②/13 A ③  9 mm / 0.35 in. ④ Approvals	22 ... 16 AWG	0.25 ... 1.5 mm ² 250 V/4 kV/3 ① 400 V/6 kV/3 ②③ I _N 16 A ①②/13 A ③  9 mm / 0.35 in. ④ Approvals	22 ... 16 AWG	Snap-on type strain relief housings for sockets and plugs
--	---------------	--	---------------	---



Color/Pole No.	Item No.	Pack. Unit	Color/Pole No.	Item No.	Pack. Unit	Color/Pole No.	Item No.	Pack. Unit
Socket without strain relief housing			Plug without strain relief housing			Strain relief housing, for 3.8 ... 8.2 mm cable diameter		
● 2 poles	890-202 ①	50	● 2 poles	890-212 ①	50	● 2 poles	890-502	50
○ 2 poles	890-222 ①	50	○ 2 poles	890-232 ①	50	○ 2 poles	890-512	50
						for 4.5 ... 10 mm cable diameter		
● 3 poles	890-203 ①	50	● 3 poles	890-213 ①	50	● 3 poles	890-503	50
○ 3 poles	890-223 ①	50	○ 3 poles	890-233 ①	50	○ 3 poles	890-513	50
						for 6.5 ... 10.5 mm cable diameter		
● 4 poles	890-204 ②	50	● 4 poles	890-214 ②	50	● 4 poles	890-504	50
○ 4 poles	890-224 ②	50	○ 4 poles	890-234 ②	50	○ 4 poles	890-514	50
						for 6.5 ... 10.5 mm cable diameter		
● 5 poles	890-205 ③	50	● 5 poles	890-215 ③	50	● 5 poles	890-505	50
○ 5 poles	890-225 ③	50	○ 5 poles	890-235 ③	50	○ 5 poles	890-515	50

Accessories, 890 Series

Locking lever, tool operated, for "flying leads"  <ul style="list-style-type: none"> ● 890-111 100 (2x50) ○ 890-131 100 (2x50) 	Locking lever, tool operated, for "flying leads"  <ul style="list-style-type: none"> ● 890-111 100 (2x50) ○ 890-131 100 (2x50)
Operating tool with a partially insulated shaft, type 1, (2.5 x 0.4) mm blade  210-719 1	Operating tool with a partially insulated shaft, type 1, (2.5 x 0.4) mm blade  210-719 1

Dimensions

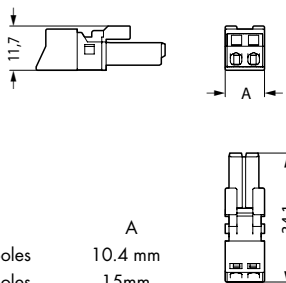
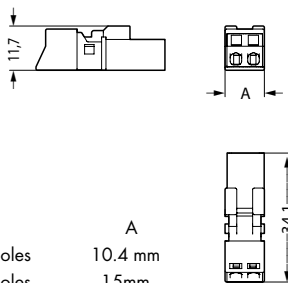
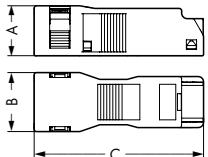

																																																														
<table border="0"> <tr> <td></td> <td>A</td> <td></td> <td></td> </tr> <tr> <td>2 poles</td> <td>10.4 mm</td> <td></td> <td></td> </tr> <tr> <td>3 poles</td> <td>15 mm</td> <td></td> <td></td> </tr> <tr> <td>4 poles</td> <td>19.2 mm</td> <td></td> <td></td> </tr> <tr> <td>5 poles</td> <td>23.6 mm</td> <td></td> <td></td> </tr> </table>		A			2 poles	10.4 mm			3 poles	15 mm			4 poles	19.2 mm			5 poles	23.6 mm			<table border="0"> <tr> <td></td> <td>A</td> <td></td> <td></td> </tr> <tr> <td>2 poles</td> <td>10.4 mm</td> <td></td> <td></td> </tr> <tr> <td>3 poles</td> <td>15 mm</td> <td></td> <td></td> </tr> <tr> <td>4 poles</td> <td>19.2 mm</td> <td></td> <td></td> </tr> <tr> <td>5 poles</td> <td>23.6 mm</td> <td></td> <td></td> </tr> </table>		A			2 poles	10.4 mm			3 poles	15 mm			4 poles	19.2 mm			5 poles	23.6 mm			<table border="0"> <tr> <td></td> <td>A</td> <td>B</td> <td>C</td> </tr> <tr> <td>2 poles</td> <td>13.2 mm</td> <td>15.6 mm</td> <td>44.8 mm</td> </tr> <tr> <td>3 poles</td> <td>14 mm</td> <td>17.9 mm</td> <td>46.8 mm</td> </tr> <tr> <td>4 poles</td> <td>16 mm</td> <td>23.2 mm</td> <td>55 mm</td> </tr> <tr> <td>5 poles</td> <td>15.8 mm</td> <td>26.7 mm</td> <td>55.15 mm</td> </tr> </table>		A	B	C	2 poles	13.2 mm	15.6 mm	44.8 mm	3 poles	14 mm	17.9 mm	46.8 mm	4 poles	16 mm	23.2 mm	55 mm	5 poles	15.8 mm	26.7 mm	55.15 mm
	A																																																													
2 poles	10.4 mm																																																													
3 poles	15 mm																																																													
4 poles	19.2 mm																																																													
5 poles	23.6 mm																																																													
	A																																																													
2 poles	10.4 mm																																																													
3 poles	15 mm																																																													
4 poles	19.2 mm																																																													
5 poles	23.6 mm																																																													
	A	B	C																																																											
2 poles	13.2 mm	15.6 mm	44.8 mm																																																											
3 poles	14 mm	17.9 mm	46.8 mm																																																											
4 poles	16 mm	23.2 mm	55 mm																																																											
5 poles	15.8 mm	26.7 mm	55.15 mm																																																											

WINSTA® MINI

Snap-In Sockets and Plugs

890 Series

PUSH-IN CAGE CLAMP®

0.25 ... 1.5 mm ² 250 V/4 kV/3 ① 400 V/6 kV/3 ②③ I _N 16 A ①②/13 A ③  9 mm / 0.35 in. ④ Approvals	22 ... 16 AWG 0.25 ... 1.5 mm ² 250 V/4 kV/3 ① 400 V/6 kV/3 ②③ I _N 16 A ①②/13 A ③  9 mm / 0.35 in. ④ Approvals
--	---



Preparation

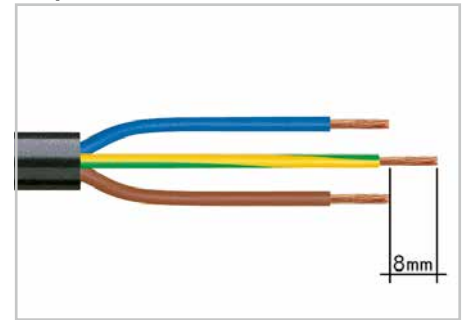

- Strip length, outer insulation = 30 mm (2-pole),
37 mm (3-pole)
45 mm (4- and 5-pole)
- Strip length = 9 mm
- Extended ground conductor = 8 mm

Termination via Push-in CAGE CLAMP®

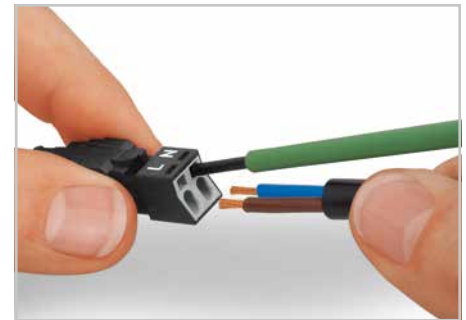

To terminate fine-stranded conductors, open clamping unit via screwdriver (2.5 mm blade width) and insert stripped conductor until it hits backstop. Solid conductors can be terminated by simply pushing them in.

Locking lever assembly



All connectors for fixed installations (snap-in versions for lighting fixtures, devices or all types of PCBs and distribution cabinets) are factory-equipped with locking levers to ensure plugs and sockets are securely locked. Additional locking levers are only required for "flying leads" (plug/socket).

Color/Pole No.	Item No.	Pack. Unit	Color/Pole No.	Item No.	Pack. Unit
Snap-in socket			Snap-in plug		
● 2 poles	890-702 ①	50	● 2 poles	890-712 ①	50
○ 2 poles	890-722 ①	50	○ 2 poles	890-732 ①	50
● 3 poles	890-703 ①	50	● 3 poles	890-713 ①	50
○ 3 poles	890-723 ①	50	○ 3 poles	890-733 ①	50
● 4 poles	890-704 ②	50	● 4 poles	890-714 ②	50
○ 4 poles	890-724 ②	50	○ 4 poles	890-734 ②	50
● 5 poles	890-705 ③	50	● 5 poles	890-715 ③	50
○ 5 poles	890-725 ③	50	○ 5 poles	890-735 ③	50

5

Accessories, 890 Series

Operating tool with a partially insulated shaft,

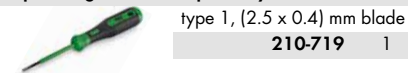

type 1, (2.5 x 0.4) mm blade
210-719 1

Operating tool with a partially insulated shaft,



type 1, (2.5 x 0.4) mm blade
210-719 1

Dimensions

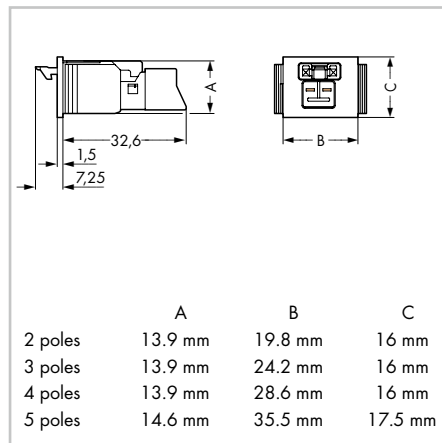
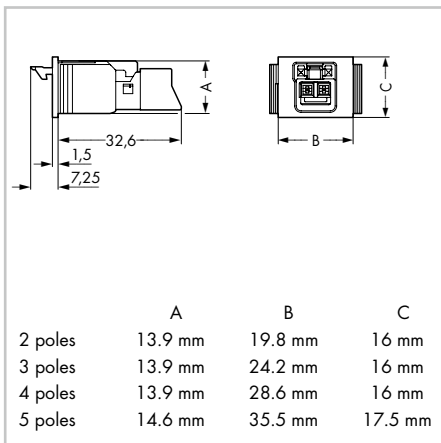

Cutout Dimensions

Plate thickness: 0.5 ... 2 mm
Cutout tolerance: +0.1 mm

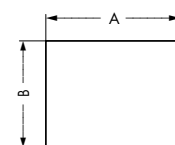

	A	B
2 poles	17.8 mm	14 mm
3 poles	22.2 mm	14 mm
4 poles	26.6 mm	14 mm
5 poles	33 mm	15.6 mm



④ For all approvals and corresponding ratings, visit www.wago.com.

For technical explanations and abbreviations, see technical section.

WINSTA® MIDI

Sockets and Plugs

770 Series

<p>2 x 0.5 ... 4 mm² 250 V/4 kV/3 ① 400 V/6 kV/3 ② I_N 25 A</p> <p> 9 mm / 0.35 in.</p> <p>③ Approvals</p>	<p>20 ... 12 AWG</p>	<p>2 x 0.5 ... 4 mm² 250 V/4 kV/3 ① 400 V/6 kV/3 ② I_N 25 A</p> <p> 9 mm / 0.35 in.</p> <p>③ Approvals</p>	<p>20 ... 12 AWG</p>	<p>Snap-on type strain relief housings for sockets and plugs</p>
--	----------------------	--	----------------------	--



Color/Pole No.	Item No.	Pack. Unit	Color/Pole No.	Item No.	Pack. Unit	Color/Pole No.	Item No.	Pack. Unit
Socket without strain relief housing			Plug without strain relief housing			Strain relief housing,		
						for 7 ... 10.5 mm cable diameter		
● 2 poles	770-202 ①	100	● 2 poles	770-212 ①	100	● 2 poles	770-502/041-000	50
○ 2 poles	770-222 ①	100	○ 2 poles	770-232 ①	100	○ 2 poles	770-512/041-000	50
						for 8 ... 11 mm cable diameter		
● 3 poles	770-203 ①	100	● 3 poles	770-213 ①	100	● 3 poles	770-503	50
○ 3 poles	770-223 ①	100	○ 3 poles	770-233 ①	100	○ 3 poles	770-513	50
						for 9 ... 13 mm cable diameter		
● 4 poles	770-204 ②	100	● 4 poles	770-214 ②	100	● 4 poles	770-504	50
○ 4 poles	770-224 ②	100	○ 4 poles	770-234 ②	100	○ 4 poles	770-514	50
						for 9 ... 13 mm cable diameter		
● 5 poles	770-205 ②	100	● 5 poles	770-215 ②	100	● 5 poles	770-505	50
○ 5 poles	770-225 ②	100	○ 5 poles	770-235 ②	100	○ 5 poles	770-515	50

Accessories, 770 Series

<p>Lockout cap, for socket, separable, 12-pole</p>  <ul style="list-style-type: none"> ● 770-201 100 ○ 770-221 100 	<p>Lockout cap, for plug, separable, 5-pole</p>  <ul style="list-style-type: none"> ● 770-360 100 	<p>Coding pin, for plug (A and B coding)</p>  <ul style="list-style-type: none"> ○ 770-401 100
<p>Locking lever, tool operated, for "flying leads"</p>  <ul style="list-style-type: none"> ● 770-111 100 (4x25) ○ 770-131 100 (4x25) 	<p>Locking lever, tool operated, for "flying leads"</p>  <ul style="list-style-type: none"> ● 770-111 100 (4x25) ○ 770-131 100 (4x25) 	<p>Operating tool with a partially insulated shaft, type 1, (2.5 x 0.4) mm blade</p>  <ul style="list-style-type: none"> ● 210-719 1

Dimensions

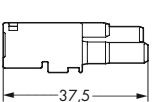
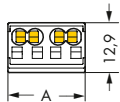
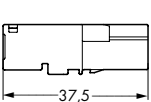
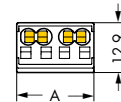
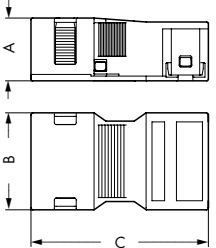
 	 	
<p>2 poles A 20 mm</p> <p>3 poles A 30 mm</p> <p>4 poles A 40 mm</p> <p>5 poles A 50 mm</p>	<p>2 poles A 20 mm</p> <p>3 poles A 30 mm</p> <p>4 poles A 40 mm</p> <p>5 poles A 50 mm</p>	<p>2 poles A 15.9 mm B 24.6 mm C 45 mm</p> <p>3 poles A 15 mm B 34.6 mm C 50 mm</p> <p>4 poles A 17 mm B 44.6 mm C 50 mm</p> <p>5 poles A 17 mm B 54.6 mm C 50 mm</p>

③ For all approvals and corresponding ratings, visit www.wago.com.



For technical explanations and abbreviations, see technical section.

WINSTA® MIDI

Snap-In Sockets and Plugs

770 Series

PUSH-IN CAGE CLAMP®

2 x 0.5 ... 4 mm ² 250 V/4 kV/3 ① 400 V/6 kV/3 ② I _N 25 A  9 mm / 0.35 in. ③ Approvals	20 ... 12 AWG	2 x 0.5 ... 4 mm ² 250 V/4 kV/3 ① 400 V/6 kV/3 ② I _N 25 A  9 mm / 0.35 in. ③ Approvals	20 ... 12 AWG
--	---------------	--	---------------



Preparation

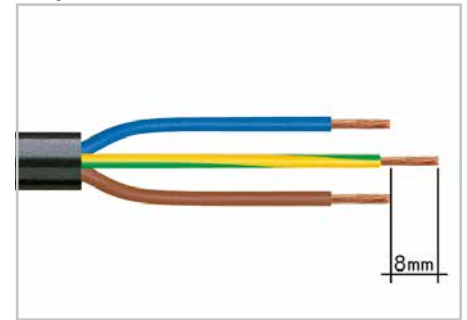

1. Strip length, outer insulation = 35 mm (2-pole),
55 mm (3-, 4- and 5-pole)
2. Strip length = 9 mm
3. Extended ground conductor = 8 mm

Termination via Push-in CAGE CLAMP®

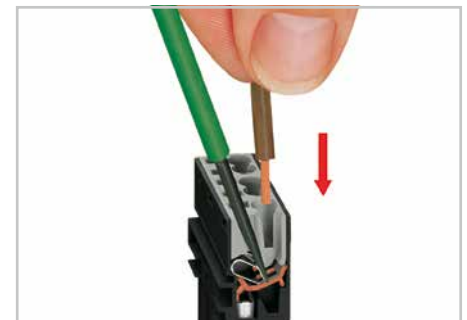

To terminate fine-stranded conductors, open the clamping unit via screwdriver (2.5 mm blade width) and insert stripped conductor until it hits backstop. Solid conductors can be terminated by simply pushing them in.





Locking lever assembly



All connectors for fixed installations (snap-in versions for lighting fixtures, devices or all types of PCBs and distribution cabinets) are factory-equipped with locking levers to ensure plugs and sockets are securely locked. Additional locking levers are only required for "flying leads" (plug/socket).

Color/Pole No.	Item No.	Pack. Unit	Color/Pole No.	Item No.	Pack. Unit
Snap-in socket			Snap-in plug		
● 3 poles	770-703 ①	100	● 3 poles	770-713 ①	100
○ 3 poles	770-723 ①	100	○ 3 poles	770-733 ①	100
● 4 poles	770-704 ②	100	● 4 poles	770-714 ②	100
○ 4 poles	770-724 ②	100	○ 4 poles	770-734 ②	100
● 5 poles	770-705 ②	100	● 5 poles	770-715 ②	100
○ 5 poles	770-725 ②	100	○ 5 poles	770-735 ②	100

Accessories, 770 Series

Lockout cap, for socket, separable, 12-pole  <ul style="list-style-type: none"> ● 770-201 100 ○ 770-221 100 	Lockout cap, for plug, separable, 5-pole  <ul style="list-style-type: none"> ● 770-360 100
Operating tool with a partially insulated shaft, type 1, (2.5 x 0.4) mm blade  <ul style="list-style-type: none"> 210-719 1 	Coding pin, for plug (A and B coding)  <ul style="list-style-type: none"> ○ 770-401 100

Dimensions

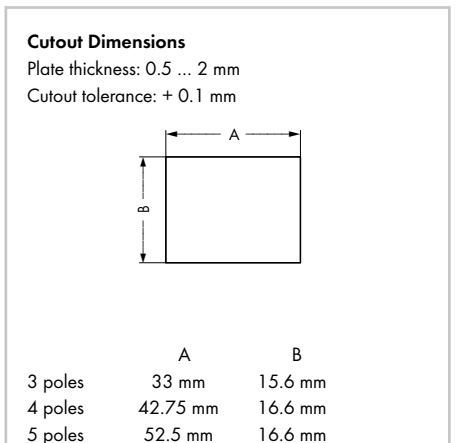
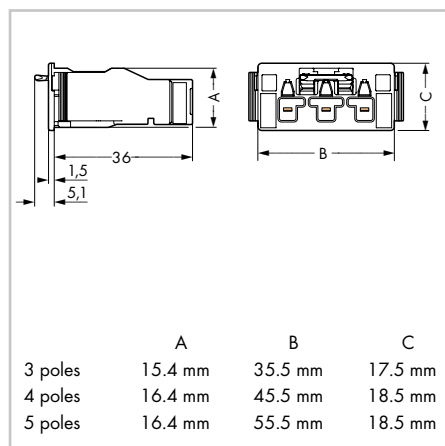
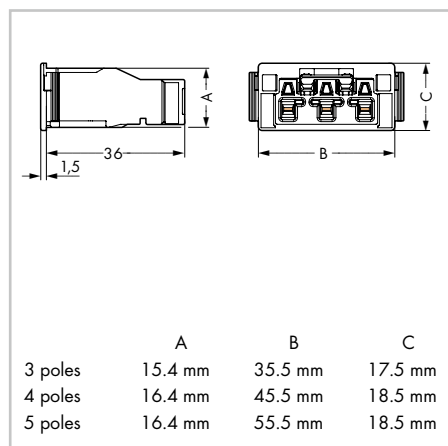

③ For all approvals and corresponding ratings, visit www.wago.com.

For technical explanations and abbreviations, see technical section.

Automation Technology

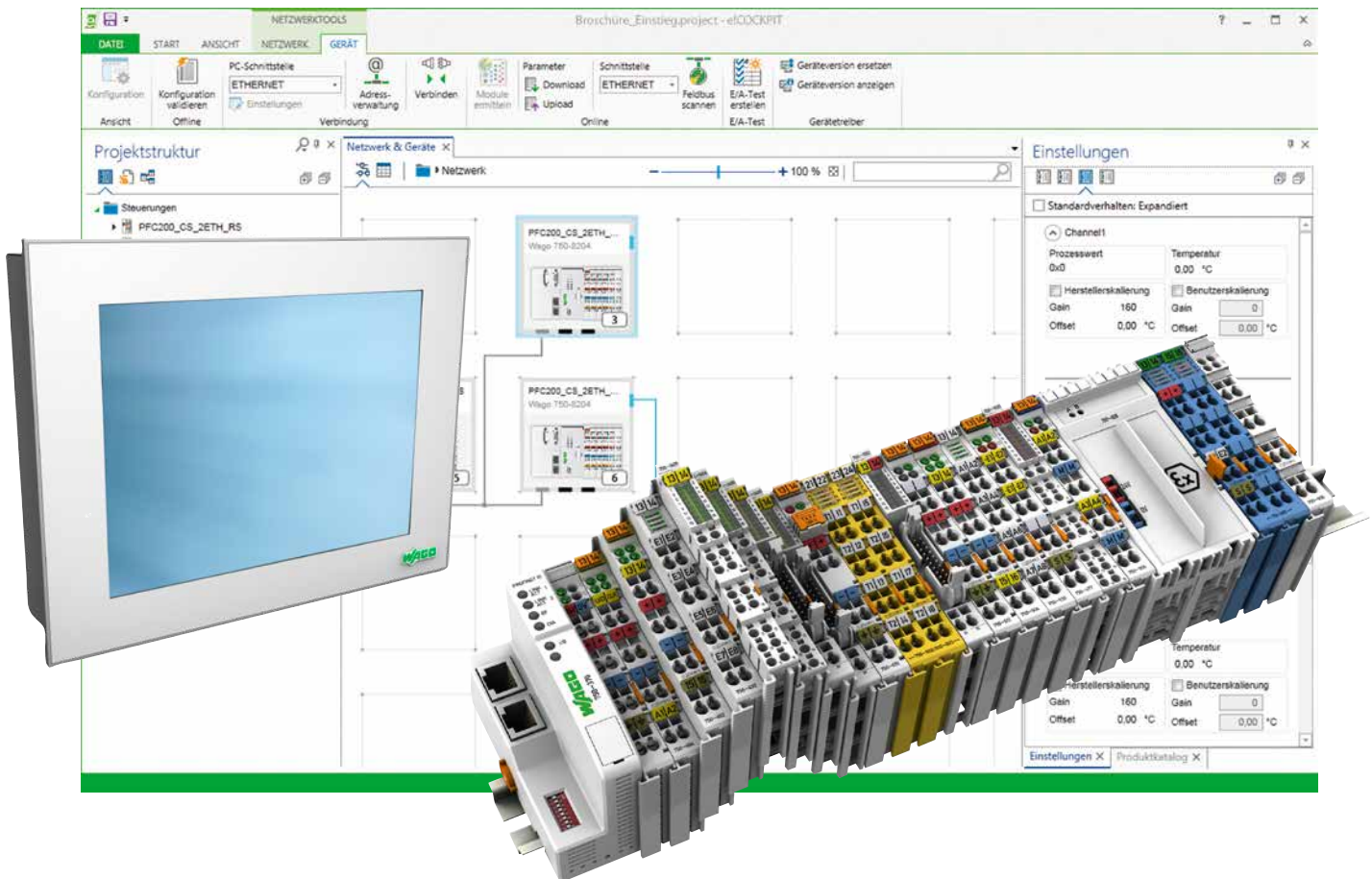













Interface Electronic

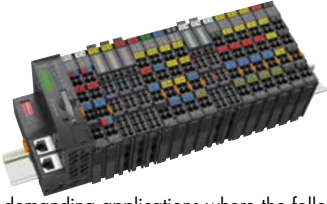
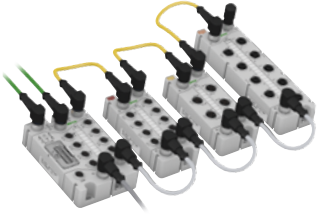

6

WAGO Automation Technology

Software	<p>Engineering Software</p>  <p>• PC-based software • Customized tools for every automation task</p>	<p>Runtime Software</p>  <p>• Standard machine component • Comprehensive, fully tested software modules for controlling, operation and monitoring</p>	<p>Mobile Software (Apps)</p>  <p>• Machine operation and monitoring on tablet and smartphone</p>
Operation & Monitoring	<p>PERSPECTO® Control Panels</p> 	<p>e!DISPLAY 7300T Web Panels</p>  <p>• Web-based visualization • 8.9 cm ... 25.6 cm (4.3" ... 10.1")</p>	<p>PERSPECTO® Web Panels</p>  <p>• Web-based visualization • 8.9 cm ... 30.7 cm (3.5" ... 12")</p>
Controllers		<p>PFC200 / PFC200 XTR</p>  <p>• High processing speed • Wide variety of interfaces • Runtime system for CODESYS 2 and 3 • Also programmable in high-level language based on Linux®</p>	<p>PFC100</p>  <p>• Extremely compact design • e!RUNTIME environment based on CODESYS 3 • Real-time Linux® operating system • TSL 1.2, IPsec, OpenVPN and firewall</p>
I/O-Systems	<p>I/O-System – 750 and 753 Series</p>  <p>• Highly versatile • More than 500 modules available • Functional safety • Ex i</p>	<p>I/O-System – 750 XTR Series</p>  <p>For demanding applications where the following are critical:</p> <ul style="list-style-type: none"> • Extreme temperature stability • Immunity to electromagnetic interference and impulse voltages • Vibration and shock resistance 	<p>I/O-System – SPEEDWAY 767 Series</p>  <p>• Uncompromising protection – even in the harshest environments outside the control cabinet • IP67 degree of protection • Fully encapsulated</p>
Infrastructure	<p>ETHERNET Switches</p>  <p>• Copper cables • Fiber optic cables • Ring redundancy</p>	<p>Radio Technology</p>  <p>• Bluetooth® • WLAN • EnOcean®</p>	<p>TO-PASS® Telecontrol Technology</p>  <p>• Telecontrol technology based on GSM/GPRS • See Full Line Catalog</p>

Software Solutions (Applications)



- Reusable, customizable solutions

Software

Engineering Software
Runtime Software
Mobile Software (Apps)
Software Solutions (Applications)

Operation & Monitoring

PERSPECTO® Web Panels
PERSPECTO® Control Panels
e!DISPLAY 7300T Web Panels

750 Series Controllers



- Decentralized intelligence based on fieldbus couplers
- Programmable to IEC 61131-3
- Modular WAGO-I/O-SYSTEM 750

750 XTR Controllers



For demanding applications where the following are critical:

- Extreme temperature stability
- Immunity to electromagnetic interference and impulse voltages
- Vibration and shock resistance

Controllers

PERSPECTO® Control Panels

PFC100/PFC200
750 Series Controllers
750 XTR Controllers

I/O-Systems

750 and 753 Series
Fieldbus Couplers
I/O Modules
750 XTR Series
SPEEDWAY

Sensor/Actuator Boxes, IP67



- Passive M8/M12 sensor/actuator boxes
- Machine-level signal connection in harsh environments

Power Supplies Accessories



Infrastructure

ETHERNET Switches
Radio Technology
TO-PASS® Telecontrol Technology
Sensor/Actuator Boxes

Accessories

Power Supplies
Cables and Pluggable Connectors, IP67

e!COCKPIT CODESYS 3-Based Integrated Engineering

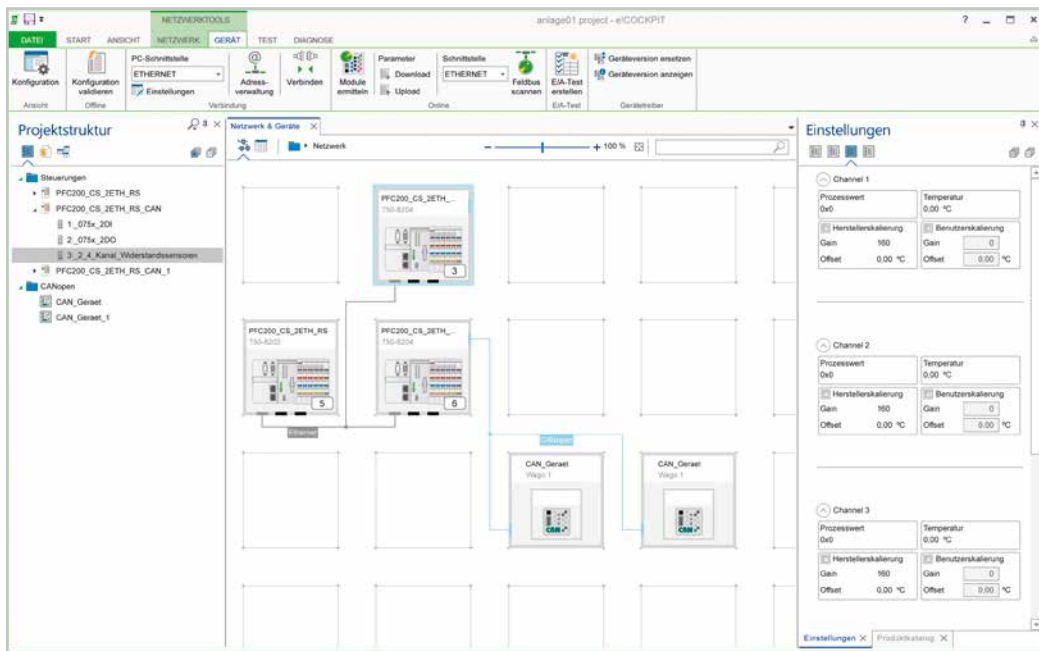

e!COCKPIT automation software for faster machine and system startup: WAGO'S new engineering software shortens development time for automation projects while impressing with a modern and clearly laid out user interface. At the software's core is CODESYS 3 for simple and versatile creation of applications.

Ensuring a project's long-term viability through sustainable cost savings hinges on a user's ability to quickly adapt to new software that offers a high degree of reusability.

WAGO set out to fulfill these exact requirements by developing its own engineering software: e!COCKPIT. This integrated development environment supports every automation task from hardware configuration, programming, simulation and visualization up to commissioning – all in one software package.

Use the programming tool to cover all important automation bases while simultaneously engineering particularly complex projects quickly and easily.

Description	Item No.	Pack. Unit	Technical Data
e!COCKPIT workstation license	2759-101/1110-2002	1	Supported operating systems Windows 7 (32- and 64-bit), Windows 8, Windows 8.1 (32- and 64-bit) System requirements: Processor: Core2Duo Memory: 2 GB Hard disk storage: 1 GB Graphics resolution: 1,366 x 768 px Supported devices Controllers based on CODESYS 3, I/O modules (750/753) Supported fieldbuses CANopen, MODBUS TCP/UDP, MODBUS RTU, PROFIBUS Supported device descriptions DTP, EDS, GSD Connectivity TCP, USB, OPC, CODESYS network variables, CODESYS DataServer Programming languages IEC 61131-3: ST, LD, FBD, IL, FC, CFC Import/export formats CODESYS 3 project files (*.project) Delivery type Installation file (download)
e!COCKPIT multi-user license, 10 ea.	2759-101/1110-2010	1	
e!COCKPIT multi-user license, 15 ea.	2759-101/1110-2015	1	
e!COCKPIT multi-user license, 20 ea.	2759-101/1110-2020	1	
e!COCKPIT site license	2759-101/1110-3000	1	
e!COCKPIT buy-out license	2759-101/1110-4000	1	
Workstation license: Can be installed on up to two PCs (e.g., notebook & desktop) Multi-user license: Can be installed up to the number specified Site license: Unlimited installations at a company location Buy-out license: Unlimited installations within a company at every country's location. In addition, the software shall be used in the company's products that contain WAGO's automation components to form a functional unit.			
Accessories	Item No.	Pack. Unit	
WAGO USB communication cable, 2.5 m long	750-923	1	
WAGO USB communication cable, 5 m long	750-923/000-001	1	
			Internet connection may be required for license activation.

e!COCKPIT

Features Overview

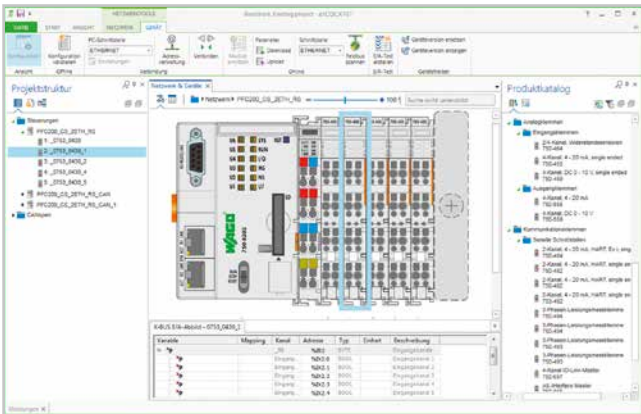

Programming

e!COCKPIT offers multiple software development options:

- IEC 61131-3 PLC programming languages: Structured Text (ST), Ladder Diagram (LD), Function Block Diagram (FBD), Instruction List (IL), Sequential Function Chart (SFC), Continuous Function Chart (CFC)
- For flexibility, all programming languages can be combined with one another
- Created programs can be easily debugged on the engineering PC via simulation
- New paradigms such as object-oriented programming are included

Configuration and Parameterization

The integrated e!COCKPIT configurators provide modern operating tools and workspaces, such as:

- Graphical network topology: Complex dependencies between network participants and their current states are easily and intuitively accessed
- Drag & Drop: Simplifies interaction with devices
- Copy & Paste: Individual devices or whole network branches can be duplicated quickly
- Batch processing: Parameter values are set simultaneously for several devices

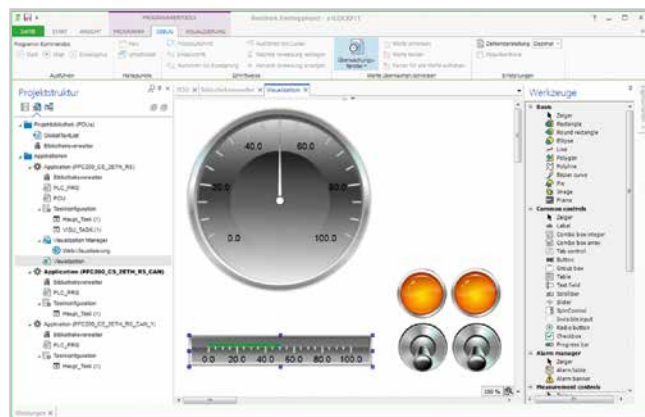
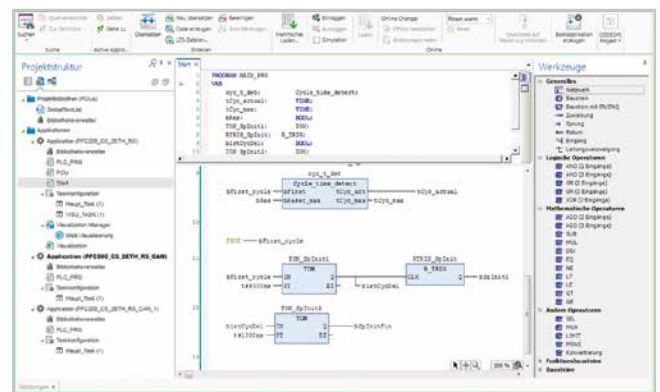

Diagnostics

Being acutely aware of the automation network's current status is an absolute must for the rapid detection and elimination of errors – be it during development in the office or directly on the machine during commissioning.

e!COCKPIT provides comprehensive diagnostic capabilities:

- Individual views always display the controllers' status information, for example, both graphically and in tabular form
- To keep the project on time, error messages are transmitted directly and clearly
- The structured wiring test program systematically identifies wiring errors

Visualization

Advanced user interfaces for operating and monitoring machines are standard. Today, HMI-based design is a critical factor that influences the purchase of an entire automation line. e!COCKPIT employs Drag & Drop to streamline the design of modern user interfaces. The integrated visualization editor provides:

- Access to IEC program variables
- Closed simulation of HMI and PLC program on the engineering PC
- Guaranteed language independence via Unicode character set
- Current standards such as HTML 5 or CSS

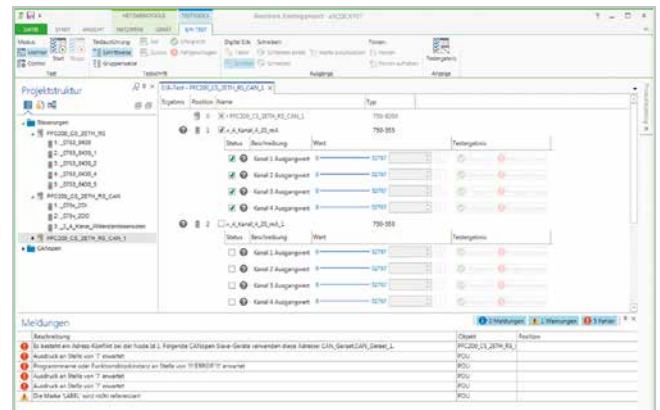

WAGO-I/O-PRO V2.3

IEC 61131-3 Programming Tool

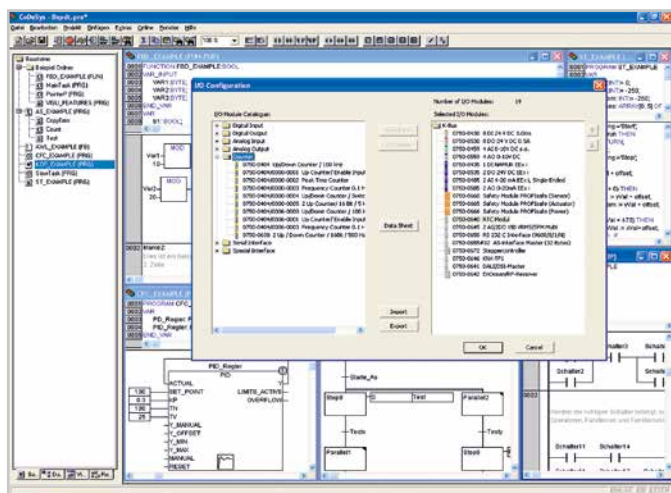

WAGO-I/O-PRO is a programming and visualization tool for control programs. This software is used to develop PLC applications for the WAGO-I/O-SYSTEM 750 Series Programmable Fieldbus Controllers.

WAGO-I/O-PRO runs in line with the IEC 61131-3 standard, which specifies the requirements for a programming system. The IL, SFC, LD, FBD and ST programming languages are supported. The optimal programming language can be chosen for each application.

With extensive programming functions, the software readily meets the increasing requirements of control program development (e.g., reusability and modularization).

WAGO-I/O-CHECK

Commissioning Tool for the WAGO-I/O-SYSTEM 750

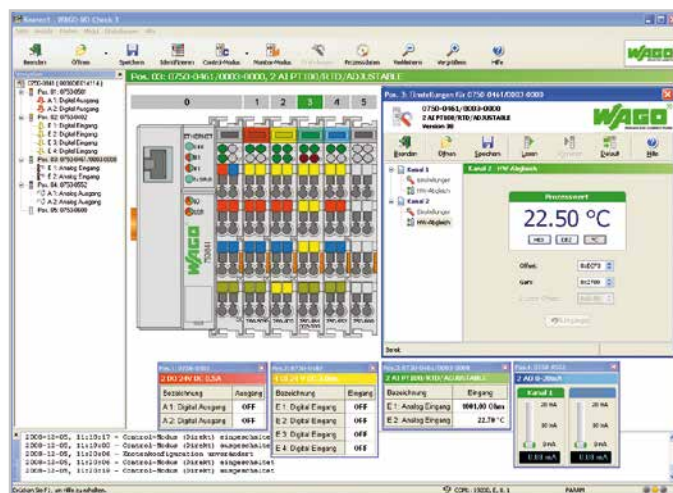

WAGO-I/O-CHECK is an easy-to-use Windows application for operating and displaying a WAGO-I/O-SYSTEM 750 node without connecting the node to a fieldbus system.

The software reads the configuration from the node and displays it as an on-screen graphic. The graphic can be printed together with a configuration list as documentation.

With WAGO-I/O-CHECK, it is possible to display and determine the process data of the bus modules. The field wiring, including all sensors and actuators, can thus be checked before startup.

Description	Item No.	Pack. Unit
WAGO-I/O-PRO V2.3, RS-232 Kit	759-333	1
WAGO-I/O-PRO V2.3, USB Kit	759-333/000-923	1
WAGO-I/O-PRO V2.3, CD-ROM	759-911	1

Approvals

Marine applications	ABS, DNV, GL, KR, NKK and RINA
---------------------	--------------------------------

Technical Data

Supported operating systems	Windows XP (SP3 or later), Windows 7
System requirements:	
Processor	1 GHz or higher, with 32 bits (x86) or 64 bits (x64)
Memory	1 GB RAM (min.), 2 GB RAM or more (recommended)
Hard disk storage	300 MB (min.)
CD-ROM	Required
Graphics resolution	1024 x 786 (min.), 1280 x 1024 or higher (recommended)
Mouse	Required
Other	Open serial interface
Delivery type	RS-232 Kit: CD-ROM with software and serial communication cable (750-920)
	USB Kit: CD-ROM with software and USB communication cable (750-923)
	CD-ROM: CD-ROM with software (without communication cable)

Windows® is a registered trademark of Microsoft Corporation.

Description	Item No.	Pack. Unit
WAGO-I/O-CHECK, RS-232 Kit	759-302	1
WAGO-I/O-CHECK, USB Kit	759-302/000-923	1
WAGO-I/O-CHECK, CD-ROM	759-920	1

Technical Data

Supported operating systems	Windows XP (SP3 or later), Windows 7
System requirements:	
Processor	1 GHz or higher, with 32 bits (x86) or 64 bits (x64)
Memory	1 GB RAM (min.), 2 GB RAM or more (recommended)
Hard disk storage	150 MB (min.)
CD-ROM	Required
Graphics resolution	1024 x 786 (min.), 1280 x 1024 or higher (recommended)
Mouse	Required
Delivery type	RS-232 Kit: CD-ROM with software and serial communication cable (750-920)
	USB Kit: CD-ROM with software and USB communication cable (750-923)
	CD-ROM: CD-ROM with software (without communication cable)

Windows® is a registered trademark of Microsoft Corporation.

WAGO WebVisu App For Mobile System Operation/Monitoring



Using the WAGO WebVisu App, you can access CODESYS 2 WebVisu websites on mobile devices. The system or machine to be monitored can then be operated and monitored at any time on the go. You can define up to 100 controllers for direct and quick access via the URL.

The free WAGO WebVisu App is available in iOS for iPhones and iPads in the Apple "App Store," and in Android for smartphones and tablets in the "Google Play™" store.

Note: An overview of the supported WAGO controllers, operating manuals and application notes can be found on our website or at www.wago.com/webvisu.

Description

WAGO WebVisu App

Technical Data

System requirements:

Operating system	iOS (version 4.3 or later) Android (version 2.2 or later)
Compatibility	iPhone, iPad and iPod touch, Android smartphones and tablets

Simply scan the QR code with your mobile device and you will automatically be directed to the WebVisu App in "App Store" or "Google Play™."



Apple, the Apple logo, iPhone, iPad and iPod touch are registered trademarks of Apple Inc. registered in the USA and other countries.

"App Store" is a service mark of Apple Inc.

"Google Play™" is a registered trademark of Google Inc.

Additional Software

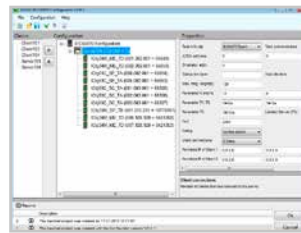

IEC 60870 Configuration Dialog

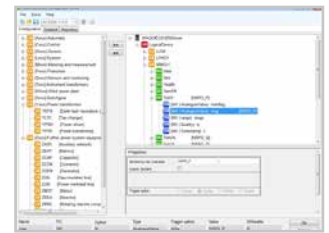

IEC 61850 Configuration Dialog

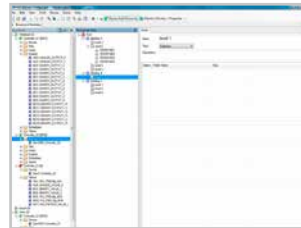

WAGO BACnet Configurator

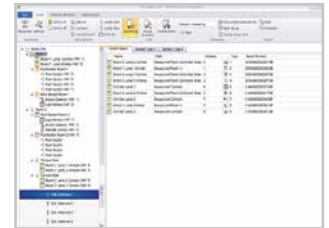

DALI Configurator

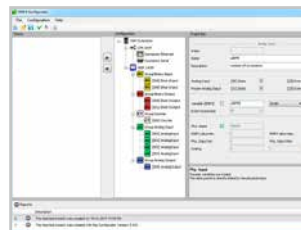

DNP3 Configurator

Description

IEC 60870 Configurator

Configuration dialog integrated in WAGO-I/O-PRO v2.3 for IEC 60870-5-101/-103/-104 communication parameterization

IEC 61850 Configurator

Configuration dialog integrated in WAGO-I/O-PRO v2.3 for IEC 61850 communication parameterization

DNP3 Configurator

Configuration dialog integrated in WAGO-I/O-PRO v2.3 for DNP3 communication parameterization

WAGO BACnet Configurator

Supported operating systems Windows XP (SP3 or later), Windows 7
For a free download, visit www.wago.com.

DALI Configurator

Included in WAGO-I/O-CHECK (version 3.5.1 and higher) or as a stand-alone application at www.wago.com

LON® Configurator





Included in WAGO-I/O-PRO (Version 2.3.9.34 and higher) at: www.wago.com

WAGO ETS Plug-In

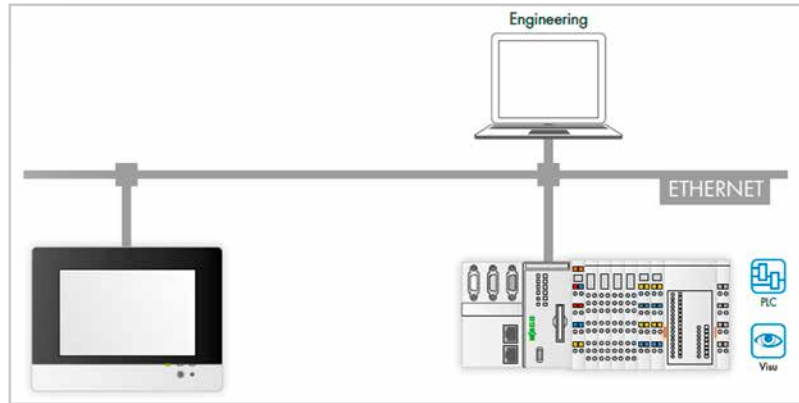
Supported operating systems Windows XP, Windows 7
For free download, visit www.wago.com.

e!DISPLAY 7300T Web Panels



	Description	Diagonal Screen Size	Screen Resolution	USB 2.0	ETHERNET/ MODBUS TCP	microSD Card	Item No.
	e!DISPLAY 7300T Web Panel	10.9 cm (4.3"), 16:9	480 x 272 pixels	2	2	1	762-3000
	e!DISPLAY 7300T Web Panel	14.5 cm (5.7"), 4:3	640 x 480 pixels	2	2	1	762-3001
	e!DISPLAY 7300T Web Panel	18 cm (7.0"), 16:9	800 x 480 pixels	2	2	1	762-3002
	e!DISPLAY 7300T Web Panel	25.7 cm (10.1"), 16:9	1280 x 800 pixels	2	2	1	762-3003

Accessories

	Description					Item No.
	Memory Card	microSD, 1 GB				758-879/000-002

Features:

- Analog, resistive (single-touch) screen
- Four display diagonals available: 4.3", 5.7", 7.0" and 10.1"
- Status LEDs (1 x operating status, 2 x operational feedback)
- Front-mount brightness adjustment
- Variable mounting position (viewing angle, horizontal/vertical: +/- 65°)
- Easy installation via universal mounting system (VESA mount) and wide mounting collar
- Protection class (front/back): IP65/IP20
- Passive cooling system

PERSPECTO® Web and Control Panels

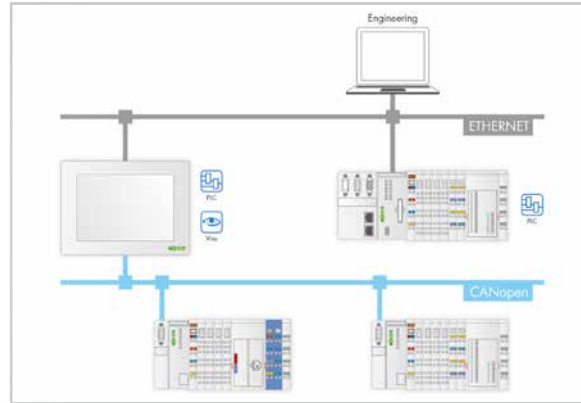

	Description	Diagonal Screen Size	Screen Resolution	USB 2.0	ETHERNET/ MODBUS TCP	CANopen	Others	Item No.
	PERSPECTO® , Web Panels	8.9 cm (3.5")	320 x 240 pixels	1			Web browser	762-1035
		14.5 cm (5.7")	320 x 240 pixels	2			Web browser	762-1057
		26.4 cm (10.4")	640 x 480 pixels	2			Web browser	762-1104
		30.7 cm (12.1")	800 x 600 pixels	2			Web browser	762-1121
	PERSPECTO® , Control Panels (programmable via CODESYS 2)	8.9 cm (3.5")	320 x 240 pixels	1	x	M/S	MODBUS RTU	762-3035/000-001
		14.5 cm (5.7")	320 x 240 pixels	2	x	M/S	MODBUS RTU	762-3057/000-001
		26.4 cm (10.4")	640 x 480 pixels	2	x	M/S	MODBUS RTU	762-3104/000-001
		30.7 cm (12.1")	800 x 600 pixels	2	x	M/S	MODBUS RTU	762-3121/000-001
		38.1 cm (15")	1024 x 768 pixels	4	x		MODBUS RTU	762-3150/000-001
		38.1 cm (15")	1024 x 768 pixels	4	x	M/S	MODBUS RTU	762-3150/000-003

6

Accessories

	Description					Pack. Unit	Item No.
	Memory Cards	CF, 1 GB				1	758-879/000-000
		SD, 2 GB				1	758-879/000-001
		microSD, 1 GB				1	758-879/000-002
	Connection Cables	DVI-D, 3 m				1	758-879/000-100
		USB A-B, 3 m				1	758-879/000-101
	Mounting Sets	for WP, CP 35				1	758-879/000-300
		for WP, CP 57				1	758-879/000-301
		for WP, CP 104				1	758-879/000-302
		for WP, CP 121				1	758-879/000-303
		for CP 150				1	758-879/000-304

M: Master, S: Slave

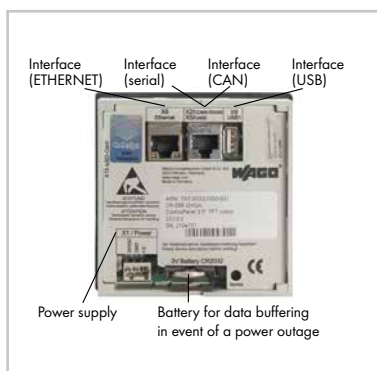

General Specifications

HBT (Half Brightness Time)	50000 hrs.
Operating system	Windows CE
Control elements	Touch, analog, resistive
Power supply	DC 24 V (18 V ... 30 V)
Operating temperature	0°C ... +50°C
Storage temperature	-10 °C ... +60 °C
Relative humidity (without condensation)	10 % ... 85 %
Protection type	Front IP65, back IP20

WAGO-I/O-SYSTEM, 750/753 Series



IEC 60870-5-101/-103/-104
IEC 61850
IEC 61400-25
DNP3

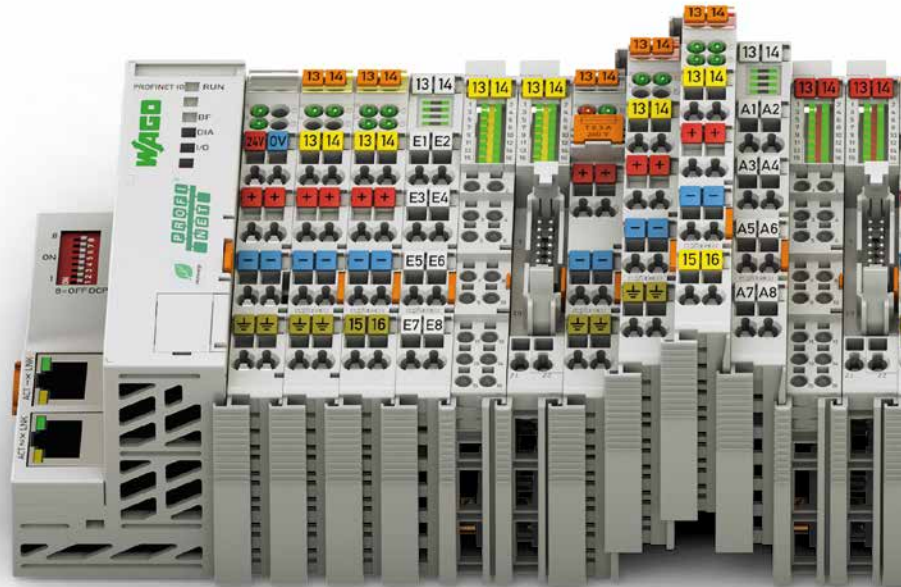

Maximum Fieldbus Independence

The system's modularity is also reflected in its support for numerous fieldbus systems and ETHERNET standards. Depending on the application, it is possible to choose between fieldbus couplers and communication modules for different protocols.

Worldwide Approvals

International approvals for building and industrial automation, as well as the process and marine industries, guarantee worldwide use – even under harsh operating conditions, e.g., ATEX, BR-Ex, IECEx, UL, UL ANSI/ISA and marine applications.

Clear Identification

Module functionality is identified via integrated or pluggable marker carriers. Terminal assignment and technical data are printed onto the side of the module. The WAGO WSB marker system also allows for module- and channel-related identification.

Extremely Compact

Our patented mechanical design leads to extremely compact I/O nodes. In fact, select I/O modules can accommodate up to 16 channels in a 12 mm (1/2") wide housing.

- Finely granular I/O modules enable node customization.
- Space-saving design permits high integration density.

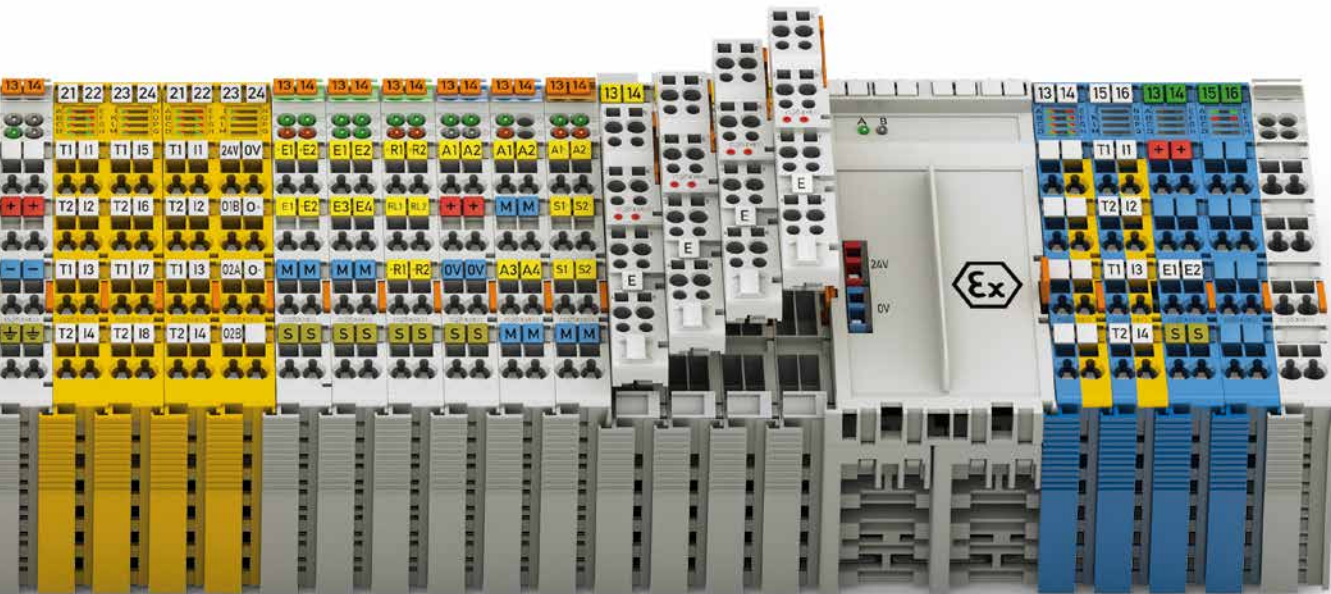

Pluggable Connections

For ultimate convenience, the 753 Series Modules are 100 % compatible with the 750 Series and feature pluggable connectors. A detachable wiring interface allows an operator to easily replace a module without removing and then rewiring all pre-existing wiring. This convenience virtually eliminates installation errors and saves time – if needed, this can be executed via placeholder modules.

Maximum Flexibility

Each node in the WAGO I/O-SYSTEM can be configured to meet each channel's requirements, and various potentials and signal types are available (granularity of 1 – 16 channels). Digital and analog I/O modules, as well as specialty modules, can be freely mixed in the same node. Supply modules permit different voltages within the same node.

Maximum Reliability and Ruggedness

The WAGO I/O-SYSTEM is engineered and tested for use in the most demanding environmental conditions in accordance with the highest standards, e.g., those required in marine applications. The system is distinguished from other products that are solely intended for industrial use because of:

- Greatly increased vibration rating
- Significantly greater immunity to interference (ESD)
- Lower emission of interference
- Larger voltage fluctuation range
- Improved ruggedness for continuous operation in upper temperature ranges

In addition, CAGE CLAMP® spring pressure connections ensure superior reliability.

Integrated QA measures in the production process and 100 % function testing ensure consistent quality.

Easy to Use

The modular, DIN-rail-mount design allows for easy, tool-free installation. The straightforward design prevents installation errors. In addition, proven CAGE CLAMP® technology offers fast, vibration-proof and maintenance-free connections that are independent of operator skill. Depending on the I/O module's granularity, field peripherals can be directly wired using 1-, 2-, 3- or 4-wire technology.

- Fieldbus-independent – Support all standard fieldbus protocols and ETHERNET standards
- Flexible platform adapts to diverse applications and environments
- Tested and approved worldwide
- Wide range of accessories for marking system and connection technology
- CAGE CLAMP® technology provides vibration-proof, fast and maintenance-free connections

WAGO-I/O-SYSTEM 750

- Description and Handling -

The Bus Module – The Universal Basic Module

Assembly



Fine modularity for DIN-rail assembly

Power jumper contacts (field side)



Safe, automatic connection by tinned, self-cleaning slide contacts with high contact safety through make-first, break-last ground contact

Data contacts

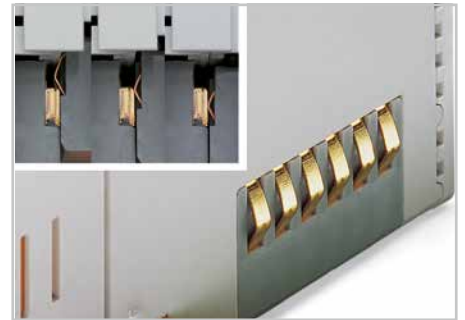

Safe, automatic connection by gold-plated, self-cleaning slide contacts with high contact safety



Secure connection with dovetails

Exchange within the assembly

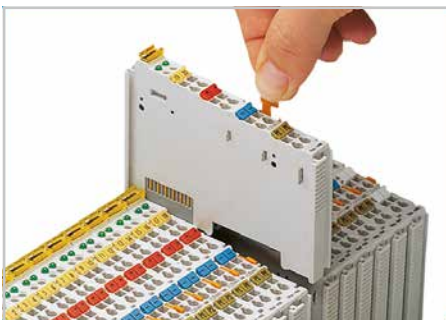

Quickly exchange a module within the assembly - without tools.

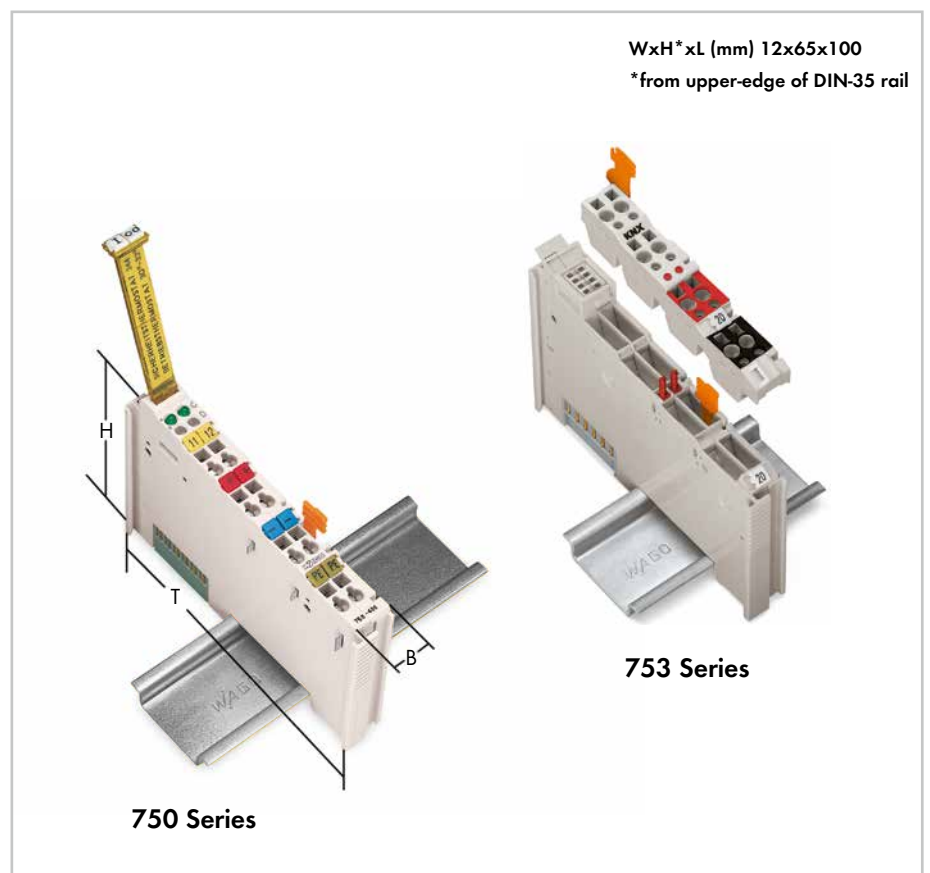

Locking the fieldbus coupler



1 Locking

2 Releasing

Accessing the programming interface



Accessing the programming interface - Programming a fieldbus controller WAGO-I/O-CHECK, WAGO-I/O-PRO CAA.

End module required

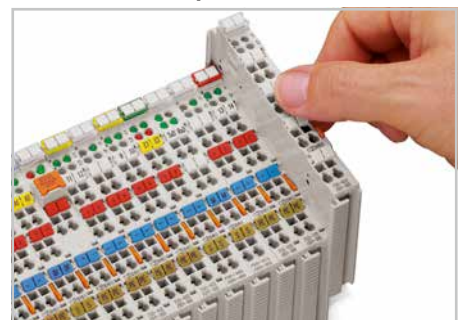

The end module physically terminates the fieldbus node and guarantees safe data transmission.

Color-coded for simplicity

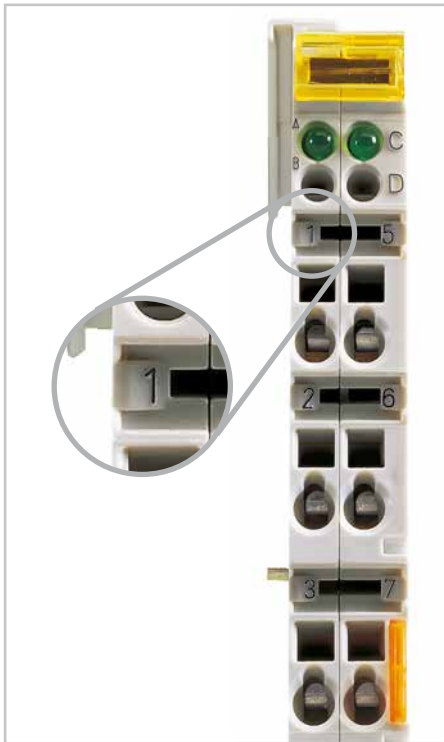

Connection points identified via factory-direct printing.

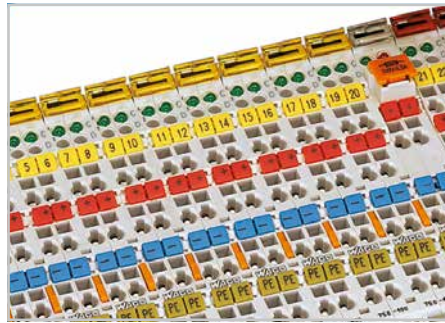

Marking clamping units via colored miniature WSB markers.



Pullout group marker carriers provide large self-marking areas.

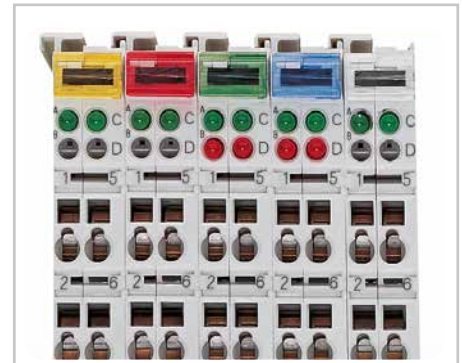

- Yellow** – Digital Inputs (DI)
- Red** – Digital Outputs (DO)
- Green** – Analog Inputs (AI)
- Blue** – Analog Outputs (AO)
- Clear** – Supply and
Specialty Modules

Transparent group marker carriers indicate module type by color.

6

CAGE CLAMP® connection

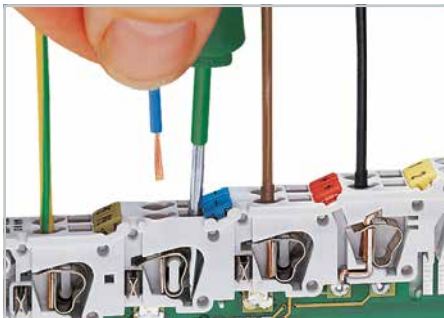

Vibration-proof, fast and maintenance-free connections for conductors ranging 0.08 ... 2.5 mm² (28 ... 14 AWG)

Status indicator

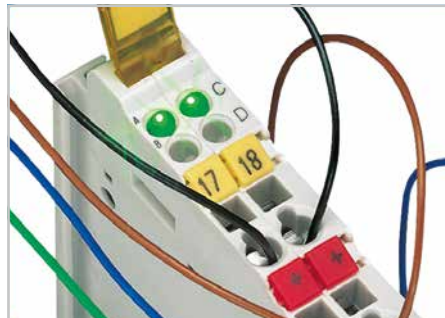

LED diagnostic and status indications for safe startup and system control.

Testing

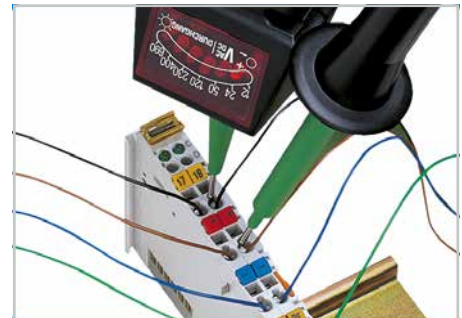

Tracing signals with wired conductors.

Fuse holder



Function at locked position 1:
Power output to I/O group is off.



Function at locked position 2:
Easy fuse replacement via hinged cover.
Use UL-recognized fuses only!

Pluggable connections













753 Series see Full Line Catalog or visit www.wago.com.

Controllers

PFC100 and PFC200

750 Series

	Description	CPU	ETHERNET MODBUS TCP	PROFIBUS	CANopen	Others	Item No.
	PFC100 CS 2ETH ECO	Cortex A8, 600 MHz	x				750-8100
	PFC100 CS 2ETH	Cortex A8, 600 MHz	x				750-8101
	PFC100 CS 2ETH/T Operating temperature: -20 °C ... +60 °C						750-8101/ 025-000
	PFC100 CS 2ETH RS	Cortex A8, 600 MHz	x				750-8102
	PFC100 CS 2ETH RS/T Operating temperature: -20 °C ... +60 °C						750-8102/ 025-000









	Description	CPU	ETHERNET MODBUS TCP	PROFIBUS	CANopen	Others	Item No.
	PFC200 CS 2ETH RS CAN DPS	Cortex A8, 600 MHz	x	S	M/S	MODBUS RTU	750-8206
	PFC200 CS 2ETH RS CAN DPS/T Operating temperature: -20 °C ... +60 °C						750-8206/ 025-000
	PFC200 CS 2ETH RS CAN DPS TELE/T Operating temperature: -20 °C ... +60 °C	Cortex A8, 600 MHz	x	S	M/S	MODBUS RTU IEC 60870-5 IEC 61850 IEC 61400-25 DNP3	750-8206/ 025-001
	PFC200 CS 2ETH RS CAN	Cortex A8, 600 MHz	x		M/S	MODBUS RTU	750-8204
	PFC200 CS 2ETH RS CAN/T Operating temperature: -20 °C ... +60 °C						750-8204/ 025-000
	PFC200 CS 2ETH CAN	Cortex A8, 600 MHz	x		M/S		750-8203
	PFC200 CS 2ETH CAN/T Operating temperature: -20 °C ... +60 °C						750-8203/ 025-000
	PFC200 CS 2ETH RS	Cortex A8, 600 MHz	x			MODBUS RTU	750-8202
	PFC200 CS 2ETH RS/T Operating temperature: -20 °C ... +60 °C						750-8202/ 025-000
	PFC200 CS 2ETH RS Telecontrol/T PFC200 CS 2ETH RS TELE ECO/T Operating temperature: -20 °C ... +60 °C	Cortex A8, 600 MHz	x			MODBUS RTU IEC 60870-5 IEC 61850 IEC 61400-25 DNP3	750-8202/ 025-001 750-8202/ 025-002
	PFC200 CS 2ETH RS 3G*	Cortex A8, 600 MHz	x			MODBUS RTU	750-8207
	PFC200 CS 2ETH RS 3G/T* PFC200 CS 2ETH RS 3G Telecontrol/T*	Cortex A8, 600 MHz	x			MODBUS RTU IEC 60870-5 IEC 61850 IEC 61400-25 DNP3	750-8207/ 025-000 750-8207/ 025-001

ETH: ETHERNET, CS: CODESYS, RS: RS-232/-485 Serial Interfaces, TELE: Telecontrol Protocol, T: Ext. Temperature Range, DPS: PROFIBUS Slave, M: Master, S: Slave
*750-8207, 750-8207/025-000 and 750-8207/025-001 are EU-only models.

Note: For PFC200 XTR, see page 177.

Controllers

750 Series

	Description	CPU	ETHERNET					PROFIBUS	CANopen	Others	Item No.
			MODBUS TCP	EtherNet/IP	BACnet/IP	KNX IP					
	ETHERNET Controller	32 bits	x	x					IEC 60870-5 IEC 61850 IEC 61400-25 DNP3	750-880 750-880/025-000* 750-880/025-001* 750-880/025-002* 750-881	
	ETHERNET Controller	32 bits	x	x					Media Redundancy	750-885 750-885/025-000* 750-882	
	Telecontroller	32 bits	x	x					MODBUS RTU IEC 60870-5 IEC 61850 IEC 61400-25 DNP3	750-872	
	ETHERNET TCP/IP Controller, RS-232	32 bits	x	x					MODBUS RTU	750-873	
	ETHERNET Controller	32 bits	x	x						750-852	
	KNX IP Controller	32 bits	x			x				750-889	
	BACnet/IP Controller	32 bits	x		x					750-831	
	BACnet/IP Controller		x		x					750-830	
	BACnet MS/TP Controller	32 bits	x						BACnet MS/TP	750-829	
	ETHERNET TCP/IP Controller	16 bits	x							750-843 750-842	
	DeviceNet Controller	16 bits							DeviceNet	750-806	
	MODBUS Controller	16 bits							MODBUS RTU	750-815/300-000 750-815/325-000* 750-816/300-000	
	PROFIBUS Controller	16 bits						S		750-833 750-833/025-000*	
	CANopen Controller	16 bits						M/S		750-837 750-838	
	INTERBUS Controller								INTERBUS	750-804	

*Operating temperature: -20 °C ... +60 °C

Note: For Controller XTR, see page 177.

Modular I/O-Systems

Fieldbus Couplers

Housing Design I with System Power Supply

Dimensions (mm) W x H x L:	51 x 65 x 100 (Height from upper-edge of DIN-rail)
Connection technology:	CAGE CLAMP®
Conductor sizes:	0.08 ... 2.5 mm ² / 28 ... 14 AWG
Strip length:	8 ... 9 mm / 0.33 in.

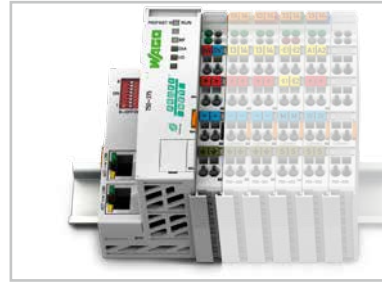
Housing Design II with System Power Supply

Dimensions (mm) W x H x L:	51 x 65 x 100 (Height from upper-edge of DIN-rail)
-------------------------------	--

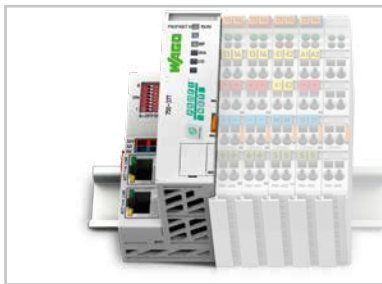
Housing Design without System Power Supply

Dimensions (mm) W x H x L:	50 x 65 x 97 (Height from upper-edge of DIN-rail)
Connection technology:	CAGE CLAMP®
Conductor sizes:	0.08 ... 1.5 mm ² / 28 ... 14 AWG
Strip length:	5 ... 6 mm / 0.22 in.

Housing Design ECO

Dimensions (mm) W x H x L:	50 x 65 x 97 (Height from upper-edge of DIN-rail)
Connection technology:	CAGE CLAMP®
Conductor sizes:	0.08 ... 1.5 mm ² / 28 ... 16 AWG
Strip length:	5 ... 6 mm / 0.22 in.

General Specifications

Operating voltage	24 VDC (-25 % ... +30 %)*; *for all marine-certified fieldbus couplers and I/O modules
Operating temperature	0 °C ... +55 °C
Operating temperature for versions with an extended temperature range	-20 °C ... +60 °C
Storage temperature	-25 °C ... +85 °C
Storage temperature for versions with an extended temperature range	-40 °C ... +85 °C
Relative humidity (without condensation)	95 %
Operating altitude	without temperature derating: 0 ... 2,000 m; with temperature derating: 2,000 ... 5,000 m (0.5 K/100 m); max.: 5,000 m
Pollution degree	2 per IEC 61131-2
Vibration resistance	0.5g (4g for all marine-certified fieldbus couplers and I/O modules) per IEC 60068-2-6
Shock resistance	15g per IEC 60068-2-27
EMC immunity to interference	per EN 61000-6-2 / marine applications
EMC emission of interference	per EN 61000-6-3 / EN 61000-6-4 / marine applications
Protection type	IP20
Mounting position	any
Mounting type	on DIN-35 rail
Housing material	polycarbonate, polyamide 6.6
Exposure to pollutants	per IEC 60068-2-42 and IEC 60068-2-43
Maximum pollutant concentration with a relative humidity < 75 %	SO ₂ ≤ 25 ppm; H ₂ S ≤ 10 ppm
Connection technology	CAGE CLAMP®
Conductor size; strip length for standard I/O modules and fieldbus couplers: 753 Series I/O Modules: ECO Fieldbus Couplers:	0.08 ... 2.5 mm ² /28 ... 14 AWG; 8 ... 9 mm/0.33 in. 0.08 ... 2.5 mm ² /28 ... 14 AWG; 9 ... 10 mm/0.37 in. 0.08 mm ² ... 1.5 mm ² /28 ... 16 AWG; 5 ... 6 mm/0.22 in.
Connection technology	Push-in CAGE CLAMP®
Conductor size; strip length for I/O modules with 16 connection points:	solid: 0.08 ... 1.5 mm ² /28 ... 16 AWG, fine-stranded: 0.25 ... 1.5 mm ² /22 ... 16 AWG; 8 ... 9 mm/0.33 in.
Current via power jumper contacts	10 A (max.)

Modular I/O-Systems

Fieldbus Couplers

750 Series

CAGE CLAMP®

Fieldbus System	Housing Design				Description	Item No.
	With System Power Supply		Without System Power Supply	ECO		
	<input type="checkbox"/>	<input type="checkbox"/>	<input type="checkbox"/>	<input type="checkbox"/>	Fieldbus Coupler, 100 Mbit	750-340
	<input type="checkbox"/>	<input type="checkbox"/>	<input type="checkbox"/>	<input type="checkbox"/>	Fieldbus Coupler, 2 ports, 100 Mbit	750-370
	<input type="checkbox"/>	<input type="checkbox"/>	<input type="checkbox"/>	<input type="checkbox"/>	Fieldbus Coupler, advanced, 2 ports	750-375
	<input type="checkbox"/>	<input type="checkbox"/>	<input type="checkbox"/>	<input type="checkbox"/>	Fieldbus Coupler, advanced, 2 ports, Operating temperature: -20 °C ... +60 °C	750-375/025-000
	<input type="checkbox"/>	<input type="checkbox"/>	<input type="checkbox"/>	<input type="checkbox"/>	Fieldbus Coupler, advanced, ECO, 2 ports, Operating temperature: -20 °C ... +60 °C	750-377/025-000
	<input type="checkbox"/>	<input type="checkbox"/>	<input type="checkbox"/>	<input type="checkbox"/>	DP/FMS Fieldbus Coupler, 12 Mbaud	750-303
	<input type="checkbox"/>	<input type="checkbox"/>	<input type="checkbox"/>	<input type="checkbox"/>	DP/V1 Fieldbus Coupler, 12 Mbaud	750-333
	<input type="checkbox"/>	<input type="checkbox"/>	<input type="checkbox"/>	<input type="checkbox"/>	DP/V1 Fieldbus Coupler, 12 Mbaud, Operating temperature: -20 °C ... +60 °C	750-333/025-000
	<input type="checkbox"/>	<input type="checkbox"/>	<input type="checkbox"/>	<input type="checkbox"/>	DP/ECO Fieldbus Coupler, 12 Mbaud	750-343
	<input type="checkbox"/>	<input type="checkbox"/>	<input type="checkbox"/>	<input type="checkbox"/>	Fieldbus Coupler with Fiber-Optic Connection, 1.5 Mbaud	750-331
	<input type="checkbox"/>	<input type="checkbox"/>	<input type="checkbox"/>	<input type="checkbox"/>	Fieldbus Coupler, 10/100 Mbit	750-352
MODBUS/TCP	<input type="checkbox"/>	<input type="checkbox"/>	<input type="checkbox"/>	<input type="checkbox"/>	Fieldbus Coupler, 10 Mbit	750-342
	<input type="checkbox"/>	<input type="checkbox"/>	<input type="checkbox"/>	<input type="checkbox"/>	Fieldbus Coupler, 100 Mbit/s	750-354
	<input type="checkbox"/>	<input type="checkbox"/>	<input type="checkbox"/>	<input type="checkbox"/>	Fieldbus Coupler, ID switch, 100 Mbit/s	750-354/000-001
	<input type="checkbox"/>	<input type="checkbox"/>	<input type="checkbox"/>	<input type="checkbox"/>	Fieldbus Coupler	750-306
	<input type="checkbox"/>	<input type="checkbox"/>	<input type="checkbox"/>	<input type="checkbox"/>	ECO Fieldbus Coupler	750-346
	<input type="checkbox"/>	<input type="checkbox"/>	<input type="checkbox"/>	<input type="checkbox"/>	Fieldbus Coupler	750-307
	<input type="checkbox"/>	<input type="checkbox"/>	<input type="checkbox"/>	<input type="checkbox"/>	Fieldbus Coupler	750-337
	<input type="checkbox"/>	<input type="checkbox"/>	<input type="checkbox"/>	<input type="checkbox"/>	Fieldbus Coupler, Operating temperature: -20 °C ... +60 °C	750-337/025-000
	<input type="checkbox"/>	<input type="checkbox"/>	<input type="checkbox"/>	<input type="checkbox"/>	Fieldbus Coupler, D-sub	750-338
	<input type="checkbox"/>	<input type="checkbox"/>	<input type="checkbox"/>	<input type="checkbox"/>	ECO Fieldbus Coupler	750-347
	<input type="checkbox"/>	<input type="checkbox"/>	<input type="checkbox"/>	<input type="checkbox"/>	ECO Fieldbus Coupler, D-sub	750-348
	<input type="checkbox"/>	<input type="checkbox"/>	<input type="checkbox"/>	<input type="checkbox"/>	Fieldbus Coupler, 2 ports, 100 Mbit	750-351
MODBUS	<input type="checkbox"/>	<input type="checkbox"/>	<input type="checkbox"/>	<input type="checkbox"/>	Fieldbus Coupler, RS-485 (150 ... 115.2 kbaud)	750-315/300-000
	<input type="checkbox"/>	<input type="checkbox"/>	<input type="checkbox"/>	<input type="checkbox"/>	Fieldbus Coupler, RS-232 (150 ... 115.2 kbaud)	750-316/300-000
	<input type="checkbox"/>	<input type="checkbox"/>	<input type="checkbox"/>	<input type="checkbox"/>	Fieldbus Coupler, 500 kbaud	750-304
	<input type="checkbox"/>	<input type="checkbox"/>	<input type="checkbox"/>	<input type="checkbox"/>	ECO Fieldbus Coupler, 500 kbaud	750-344
	<input type="checkbox"/>	<input type="checkbox"/>	<input type="checkbox"/>	<input type="checkbox"/>	ECO Fieldbus Coupler, 2 Mbaud	750-345
	<input type="checkbox"/>	<input type="checkbox"/>	<input type="checkbox"/>	<input type="checkbox"/>	Fieldbus Coupler with Fiber-Optic Connection	750-334
	<input type="checkbox"/>	<input type="checkbox"/>	<input type="checkbox"/>	<input type="checkbox"/>	Fieldbus Coupler	750-310

Modular I/O-Systems

Digital Input Modules



750/753 Series Housing Design

Dimensions (mm) W x H x L:	12 x 65 x 100 (Height from upper-edge of DIN-rail)
Connection technology:	CAGE CLAMP®
Conductor sizes:	0.08 ... 2.5 mm ² / 28 ... 14 AWG
Strip length:	750 Series: 8 ... 9 mm / 0.33 in. 753 Series: 9 ... 10 mm / 0.37 in.

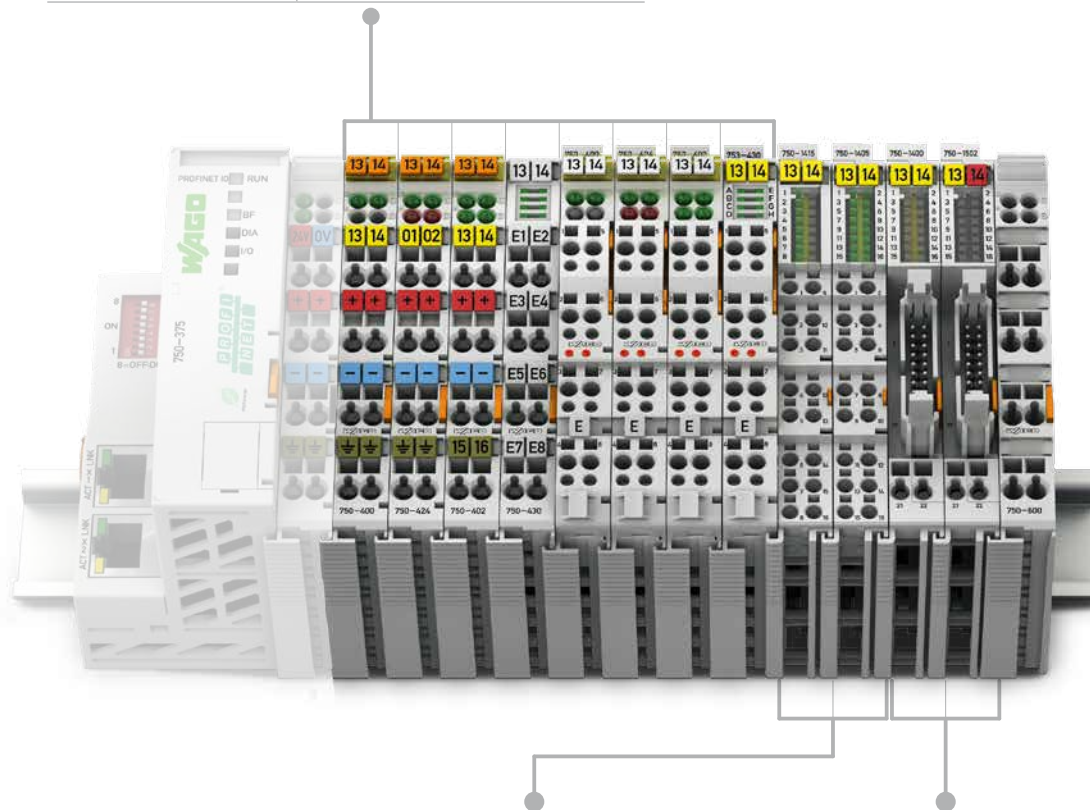

750 Series Housing Design with Push-in CAGE CLAMP® (Up to 16 Connection Points)

Connection technology:	Push-in CAGE CLAMP®
Conductor sizes:	solid: 0.08 ... 2.5 mm ² / 28 ... 16 AWG fine-stranded: 0.25 ... 1.5 mm ² / 22 ... 16 AWG
Strip length:	8 ... 9 mm / 0.33 in.

750 Series Housing Design with Ribbon Cable Connection

Dimensions (mm) W x H x L:	12 x 73 x 100 (Height from upper-edge of DIN-rail)
Connection technology:	20-pole male connector/ CAGE CLAMP®



Modular I/O-Systems

Digital Inputs

750 Series

CAGE CLAMP®
PUSH-IN CAGE CLAMP®

Function	2-Channel DI	4-Channel DI	8-Channel DI	8-Channel DIO	16-Channel DI	Description	Item No.		
							Standard	Operating Temperature: /T -20 °C ... +60 °C	Pluggable (Connector, Page 178)
5 VDC		<input type="checkbox"/>				0.2 ms, high-side switching	750-414		
5/12 VDC			<input type="checkbox"/>			(5 ... 14 VDC) 0.2 ms, high-side switching			753-434
24 VDC	<input type="checkbox"/>					3.0 ms, high-side switching	750-400	750-400/025-000	753-400
	<input type="checkbox"/>					0.2 ms, high-side switching	750-401		753-401
	<input type="checkbox"/>					3.0 ms, high-side switching, proximity switch	750-410		753-410
	<input type="checkbox"/>					0.2 ms, high-side switching, proximity switch	750-411		753-411
	<input type="checkbox"/>					3.0 ms, high-side switching, diagnostics, acknowledgment	750-418		753-418
	<input type="checkbox"/>					3.0 ms, high-side switching, diagnostics	750-421		753-421
	<input type="checkbox"/>					NAMUR, proximity switch per DIN EN 60947-5-6	750-425		753-425
	<input type="checkbox"/>					Intruder detection	750-424		753-424
		<input type="checkbox"/>				3.0 ms, high-side switching	750-402	750-402/025-000	753-402
		<input type="checkbox"/>				0.2 ms, high-side switching	750-403		753-403
		<input type="checkbox"/>				3.0 ms, high-side switching	750-432		753-432
		<input type="checkbox"/>				0.2 ms, high-side switching	750-433		753-433
		<input type="checkbox"/>				Pulse extension, 10 ms	750-422		753-422
		<input type="checkbox"/>				3.0 ms, low-side switching	750-408	750-408/025-000	753-408
		<input type="checkbox"/>				0.2 ms, low-side switching	750-409		753-409
		<input type="checkbox"/>				3.0 ms, 3-conductor	750-1420		
		<input type="checkbox"/>				0.2 ms, 3-conductor	750-1421		
		<input type="checkbox"/>				3.0 ms, low-side switching, 3-conductor	750-1422		
		<input type="checkbox"/>				0.2 ms, low-side switching, 3-conductor	750-1423		
			<input type="checkbox"/>			3.0 ms, high-side switching	750-430	750-430/025-000	753-430
			<input type="checkbox"/>			0.2 ms, high-side switching	750-431		753-431
			<input type="checkbox"/>			3.0 ms, low-side switching	750-436		753-436
			<input type="checkbox"/>			0.2 ms, low-side switching	750-437		753-437
			<input type="checkbox"/>			3.0 ms, 2-conductor	750-1415		
			<input type="checkbox"/>			0.2 ms, 2-conductor	750-1416		
			<input type="checkbox"/>			3.0 ms, low-side switching, 2-conductor	750-1417		
			<input type="checkbox"/>			0.2 ms, low-side switching, 2-conductor	750-1418		
				<input type="checkbox"/>		0.5 A, high-side switching, ribbon cable	750-1502		
				<input type="checkbox"/>		0.5 A, high-side switching	750-1506		
				<input type="checkbox"/>	3.0 ms, high-side switching, ribbon cable	750-1400			
				<input type="checkbox"/>	3.0 ms, high-side switching	750-1405			
				<input type="checkbox"/>	0.2 ms, high-side switching	750-1406			
				<input type="checkbox"/>	3.0 ms, low-side switching, ribbon cable	750-1402			
				<input type="checkbox"/>	3.0 ms, low-side switching	750-1407			
24 V AC/DC		<input type="checkbox"/>				20 ms	750-415		753-415
		<input type="checkbox"/>				50 ms, power jumper contacts	750-423		753-423
42 V AC/DC		<input type="checkbox"/>				20 ms	750-428		753-428
48 VDC	<input type="checkbox"/>					3.0 ms, high-side switching	750-412		753-412
60 VDC	<input type="checkbox"/>					3.0 ms, high-side switching			753-429
110 VDC	<input type="checkbox"/>					3.0 ms, high-side or low-side switching	750-427		753-427
220 VDC	<input type="checkbox"/>					3.0 ms, high-side switching	750-407		
120 VAC	<input type="checkbox"/>					10 ms, high-side switching	750-406		753-406
120/230 VAC		<input type="checkbox"/>				(120 ... 230 VAC) 10 ms, high-side switching			753-440
230 VAC	<input type="checkbox"/>					10 ms, high-side switching	750-405		753-405
PTC			<input type="checkbox"/>			Connection to PTC thermistors per DIN 44081/44082	750-1425		
Functional Safety							See page 174		
Ex i							See page 175		

Modular I/O-Systems

Digital Output Modules



750/753 Series Housing Design

Dimensions (mm) W x H x L:	12 x 65 x 100 (Height from upper-edge of DIN-rail)
Connection technology:	CAGE CLAMP®
Conductor sizes:	0.08 ... 2.5 mm ² / 28 ... 14 AWG
Strip length:	750 Series: 8 ... 9 mm / 0.33 in. 753 Series: 9 ... 10 mm / 0.37 in.

750 Series Specialty Housing

Dimensions (mm) W x H x L:	24 x 65 x 100 (Height from upper-edge of DIN-rail)
----------------------------	---

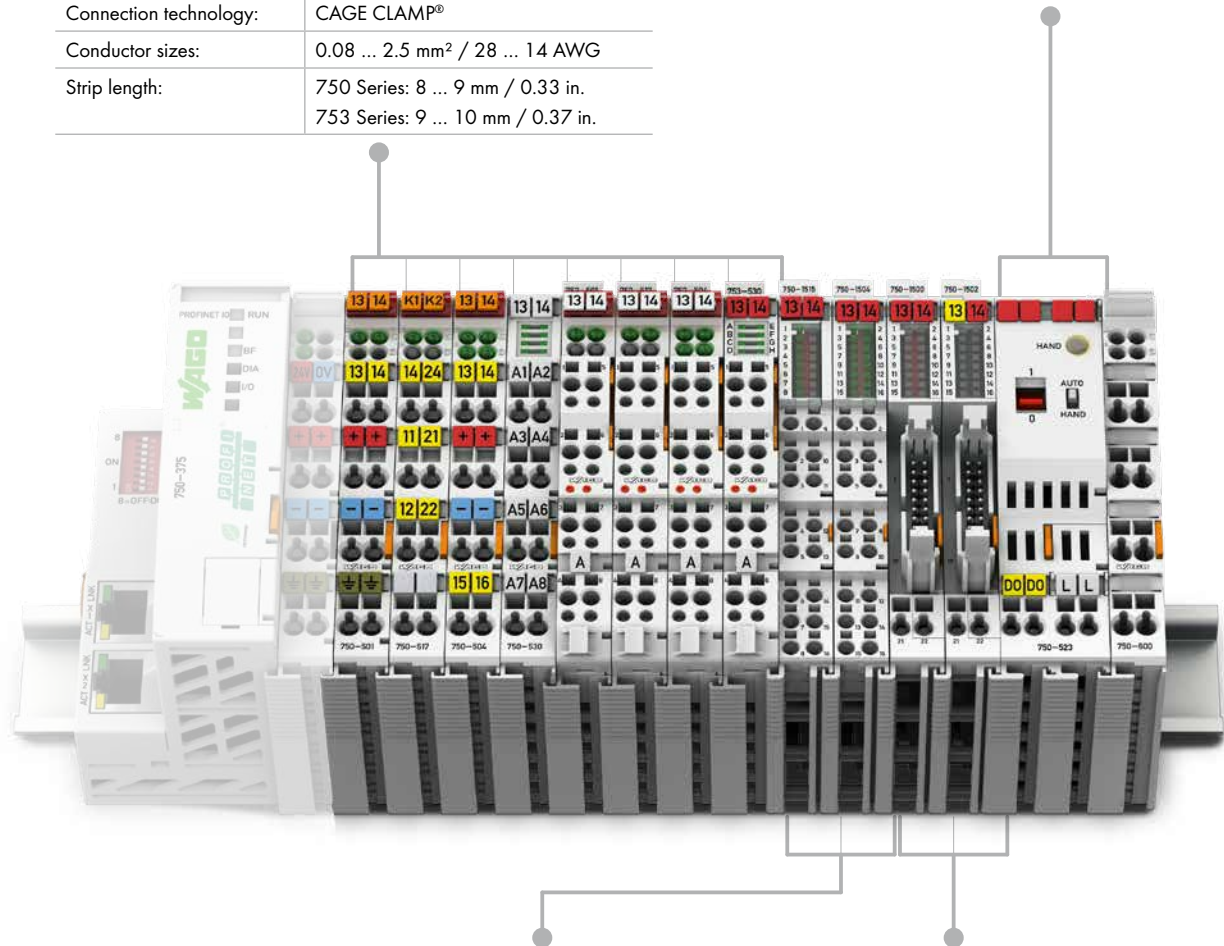

750 Series Housing Design with Push-in CAGE CLAMP® (Up to 16 Connection Points)

Connection technology:	Push-in CAGE CLAMP®
Conductor sizes:	solid: 0.08 ... 2.5 mm ² / 28 ... 16 AWG fine-stranded: 0.25 ... 1.5 mm ² / 22 ... 16 AWG
Strip length:	8 ... 9 mm / 0.33 in.

750 Series Housing Design with Ribbon Cable Connection

Dimensions (mm) W x H x L:	12 x 73 x 100 (Height from upper-edge of DIN-rail)
Connection technology:	20-pole male connector/ CAGE CLAMP®



Modular I/O-Systems

Digital Outputs

750 Series

CAGE CLAMP®
PUSH-IN CAGE CLAMP®

Function	1-Channel DO	2-Channel DO	4-Channel DO	8-Channel DO	8-Channel DIO	16-Channel DO	Description	Item No.		
								Standard	/T Operating Temperature: -20 °C ... +60 °C	Pluggable (Connector, Page 178)
5 VDC			■				High-side switching	750-519		
5/12 VDC				■			(5 ... 14 VDC) 1 A, short-circuit-protected, high-side switching	750-534		753-534
24 VDC		■					0.5 A, short-circuit-protected, high-side switching	750-501		753-501
		■					0.5 A, short-circuit-protected, high-side switching, interference-free	750-501/000-800		753-501/000-800
		■					2.0 A, short-circuit-protected, high-side switching	750-502		753-502
		■					2.0 A, short-circuit-protected, high-side switching, interference-free	750-502/000-800		753-502/000-800
		■					0.5 A, diagnostics, short-circuit-protected, high-side switching	750-506		753-506
		■					0.5 A, diagnostics, short-circuit-protected, high-side switching, interference-free	750-506/000-800		
		■					2.0 A, diagnostics, short-circuit-protected, high-side switching	750-508		753-508
		■					2.0 A, diagnostics, short-circuit-protected, high-side switching, interference-free	750-508/000-800		
				■			0.5 A, short-circuit-protected, high-side switching	750-504	750-504/025-000	753-504
				■			0.5 A, short-circuit-protected, high-side switching, interference-free	750-504/000-800	750-504/025-800	
				■			0.5 A, 2-conductor, short-circuit-protected, high-side switching	750-531		753-531
				■			0.5 A, 2-conductor, short-circuit-protected, high-side switching, interference-free	750-531/000-800		753-531/000-800
				■			Short-circuit-protected, low-side switching	750-516		753-516
				■			0.5 A, 2-conductor, diagnostics, short-circuit-protected, high-side switching	750-532		
					■		0.5 A, short-circuit-protected, high-side switching	750-530	750-530/025-000	753-530
					■		0.5 A, short-circuit-protected, low-side switching	750-536		753-536
					■		0.5 A, diagnostics, short-circuit-protected, high-side switching	750-537		753-537
					■		0.5 A, 2-conductor	750-1515		
					■		0.5 A, low-side switching, 2-conductor	750-1516		
						■	0.5 A, high-side switching, ribbon cable	750-1502		
					■	0.5 A, high-side switching	750-1506			
					■	0.5 A, high-side switching, ribbon cable	750-1500			
					■	0.5 A, high-side switching	750-1504			
					■	0.5 A, low-side switching, ribbon cable	750-1501			
					■	0.5 A, low-side switching	750-1505			
120/230 VAC			■				(120 ... 230 VAC) 0.25 A, high-side switching			753-540
230 VAC/DC		■					0.3 A, solid-state relay	750-509		753-509
230 VAC		■					0.5 A, solid-state relay (3 A < 30 ms)	750-522		
Relay		■					2 changeover contacts, potential-free, 125 VAC, 0.5 A	750-514		753-514
		■					2 changeover contacts, potential-free, 230 VAC, 1 A	750-517		753-517
		■					2 make contacts, non-floating, 230 VAC, 2 A	750-512		753-512
		■					2 make contacts, potential-free, 230 VAC, 2 A	750-513		753-513
		■					2 make contacts, potential-free, 230 VAC, 2 A, without power jumper contacts	750-513/000-001		
	■					1 make contact, potential-free, manual operation, 230 VAC, 16 A	750-523			
Functional Safety								See page 174		
Ex i								See page 175		

Modular I/O-Systems

Analog Input Modules



750/753 Series Housing Design

Dimensions (mm) W x H x L:	12 x 65 x 100 (Height from upper-edge of DIN-rail)
Connection technology:	CAGE CLAMP®
Conductor sizes:	0.08 ... 2.5 mm ² / 28 ... 14 AWG
Strip length:	750 Series: 8 ... 9 mm / 0.33 in. 753 Series: 9 ... 10 mm / 0.37 in.

750 Series Housing Design, Double Width

Dimensions (mm) W x H x L:	24 x 65 x 100 (Height from upper-edge of DIN-rail)
----------------------------	---

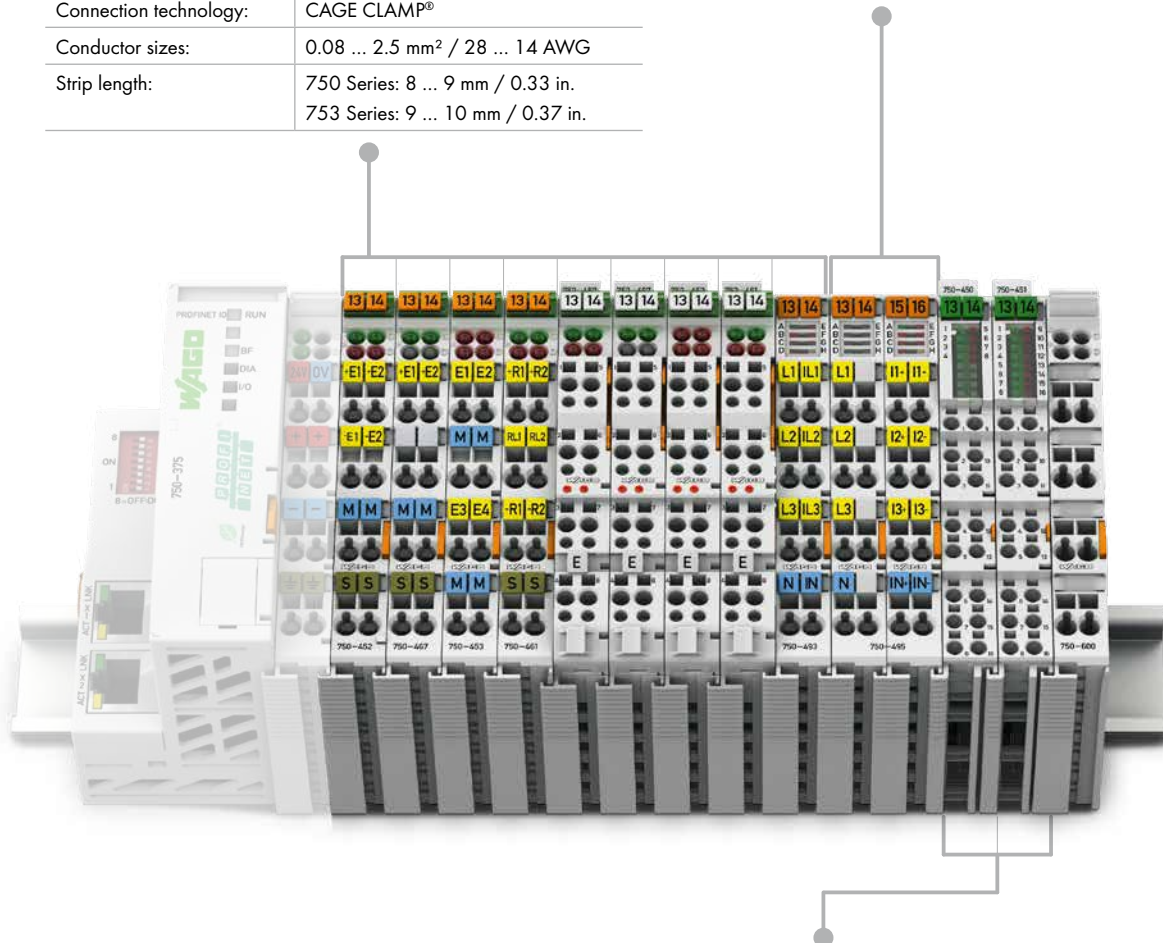

750 Series Housing Design with Push-in CAGE CLAMP® Connections (Up to 16 Connection Points)

Connection technology:	Push-in CAGE CLAMP®
Conductor sizes:	solid: 0.08 ... 2.5 mm ² / 28 ... 16 AWG fine-stranded: 0.25 ... 1.5 mm ² / 22 ... 16 AWG
Strip length:	8 ... 9 mm / 0.33 in.



Modular I/O-Systems

Analog Inputs

750 Series

CAGE CLAMP®
PUSH-IN CAGE CLAMP®

Function	1-Channel AI	2-Channel AI	4-Channel AI	8-Channel AI	Description	Item No.			
						Standard	/S5 or /S7 Customized Data Format	/T Operating Temperature: -20 °C ... +60 °C	Pluggable (Connector, Page 178)
0 ... 20 mA		<input checked="" type="checkbox"/>			Differential input	750-452	750-452/000-200		753-452
		<input checked="" type="checkbox"/>			Single-ended	750-465		750-465/025-000	753-465
		<input checked="" type="checkbox"/>			Single-ended, short-circuit-protected	750-470			
		<input checked="" type="checkbox"/>			Single-ended, short-circuit-protected, 60 Hz	750-470/005-000			
		<input checked="" type="checkbox"/>			Single-ended, 16 bits	750-472	750-472/000-200		753-472
		<input checked="" type="checkbox"/>			Single-ended, 16 bits, 60 Hz	750-472/005-000			
		<input checked="" type="checkbox"/>			Differential input	750-480			753-480
		<input checked="" type="checkbox"/>			Differential input, synchronous	750-480/000-001			
4 ... 20 mA			<input checked="" type="checkbox"/>		Single-ended	750-453			753-453
		<input checked="" type="checkbox"/>			Differential input	750-454	750-454/000-200	750-454/025-000	753-454
		<input checked="" type="checkbox"/>			Single-ended	750-466	750-466/000-200	750-466/025-000	753-466
		<input checked="" type="checkbox"/>			Single-ended, short-circuit-protected	750-473			
		<input checked="" type="checkbox"/>			Single-ended, short-circuit-protected, 60 Hz	750-473/005-000			
		<input checked="" type="checkbox"/>			Single-ended, 16 bits	750-474	750-474/000-200		753-474
		<input checked="" type="checkbox"/>			Single-ended, 16 bits, 60 Hz	750-474/005-000			
		<input checked="" type="checkbox"/>			Differential input	750-492			753-492
0/4 ... 20 mA				<input checked="" type="checkbox"/>	Single-ended, 16 bits, HART	750-482	750-482/000-300	750-482/025-000	753-482
			<input checked="" type="checkbox"/>		Single-ended	750-455		750-455/025-000	753-455
				<input checked="" type="checkbox"/>	Single-ended	750-455/020-000			
				<input checked="" type="checkbox"/>	Single-ended	750-496			
0 ... 1 A	<input checked="" type="checkbox"/>				Differential input	750-475			753-475
0 ... 5 A	<input checked="" type="checkbox"/>				Differential input	750-475/020-000			
± 10 V	<input checked="" type="checkbox"/>				Differential input	750-456	750-456/000-200		753-456
	<input checked="" type="checkbox"/>				Differential input	750-479			753-479
	<input checked="" type="checkbox"/>				Differential input, synchronous	750-479/000-001			
	<input checked="" type="checkbox"/>				Single-ended, 16 bits	750-476	750-476/000-200		753-476
0 ... 10 V		<input checked="" type="checkbox"/>			Single-ended	750-457		750-457/025-000	753-457
	<input checked="" type="checkbox"/>				Differential input	750-477			753-477
	<input checked="" type="checkbox"/>				Single-ended	750-467	750-467/000-200		753-467
	<input checked="" type="checkbox"/>				Single-ended, 16 bits	750-478			753-478
± 10 V/0 ... 10 V			<input checked="" type="checkbox"/>		Single-ended, 16 bits, 60 Hz	750-478/005-000			
			<input checked="" type="checkbox"/>		Single-ended	750-468	750-468/000-200	750-468/025-000	
				<input checked="" type="checkbox"/>	Single-ended	750-459			753-459
				<input checked="" type="checkbox"/>	Single-ended	750-497			
Resistance Sensors	<input checked="" type="checkbox"/>				Differential input	750-483			753-483
	<input checked="" type="checkbox"/>				Pt100 / RTD / NTC 20 kΩ	750-461	750-461/000-200	750-461/025-000	753-461
	<input checked="" type="checkbox"/>				Pt100 / configurable	750-461/003-000			753-461/003-000
	<input checked="" type="checkbox"/>				NTC 20k	750-461/020-000			
	<input checked="" type="checkbox"/>				Resistance measurement (other variants)	750-461/000-00x			
			<input checked="" type="checkbox"/>		Pt100 / RTD	750-460			
			<input checked="" type="checkbox"/>		Pt1000 / RTD	750-460/000-003			
			<input checked="" type="checkbox"/>		Ni1000 TK6180 / RTD	750-460/000-005			
Thermocouples			<input checked="" type="checkbox"/>		4AI RTD (building automation)	750-463			
		<input checked="" type="checkbox"/>			RTD, configurable	750-464			
		<input checked="" type="checkbox"/>			NTC, configurable	750-464/020-000			
		<input checked="" type="checkbox"/>			4AI RTD, configurable	750-450			
				<input checked="" type="checkbox"/>	8AI RTD, configurable	750-451			
		<input checked="" type="checkbox"/>			K/Diagnostics	750-469	750-469/000-200		753-469
		<input checked="" type="checkbox"/>			J/Diagnostics	750-469/000-006			
		<input checked="" type="checkbox"/>			Configurable	750-469/003-000			753-469/003-000
Analog Specialty Functions				<input checked="" type="checkbox"/>	S; T; ±120 mV; E; L/Diagnostics	750-469/000-00x			
				<input checked="" type="checkbox"/>	8AI Thermocouple, configurable	750-458			
	<input checked="" type="checkbox"/>				Resistor bridges (strain gauge)	750-491			
		<input checked="" type="checkbox"/>			Resistor bridges (strain gauge), 125 ms	750-491/000-001			
		<input checked="" type="checkbox"/>			(1A)	750-493			
		<input checked="" type="checkbox"/>			(5A)	750-493/000-001			
		<input checked="" type="checkbox"/>			(480V/1A)	750-494		750-494/025-000	
		<input checked="" type="checkbox"/>			3-phase power measurement module (480V/5A)	750-494/000-001		750-494/025-001	
	<input checked="" type="checkbox"/>			(690V/1A)	750-495				
	<input checked="" type="checkbox"/>			(690V/5A)	750-495/000-001				
	<input checked="" type="checkbox"/>			(690V/RC)	750-495/000-002				

Exi

See page 175

Modular I/O-Systems

Analog Output Modules



750/753 Series Housing Design

Dimensions (mm) W x H x L:	12 x 65 x 100 (Height from upper-edge of DIN-rail)
Connection technology:	CAGE CLAMP®
Conductor sizes:	0.08 ... 2.5 mm ² / 28 ... 14 AWG
Strip length:	750 Series: 8 ... 9 mm / 0.33 in. 753 Series: 9 ... 10 mm / 0.37 in.

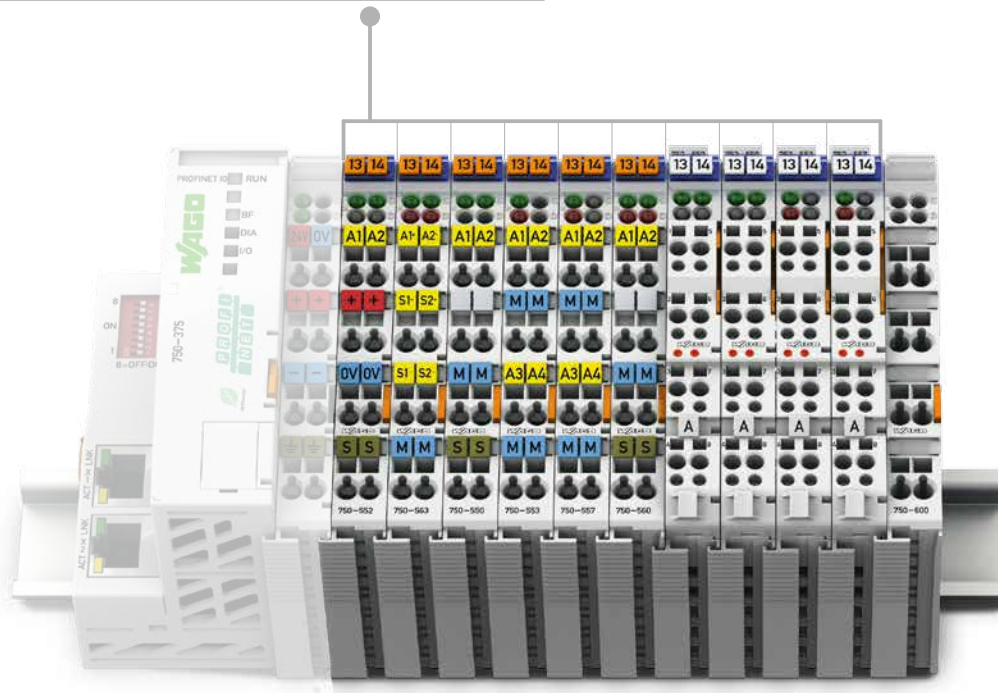

Modular I/O-Systems

Analog Outputs

750 Series

CAGE CLAMP®

Function	2-Channel AO	4-Channel AO	Description	Item No.			
				Standard	/S5 Customized Data Format	/T Operating Temperature: -20 °C ... +60 °C	Pluggable (Connector, Page 178)
0 ... 20 mA	■		12 bits	750-552	750-552/000-200	750-552/025-000	753-552
		■	12 bits	750-553			753-553
4 ... 20 mA	■		12 bits	750-554	750-554/000-200	750-554/025-000	753-554
		■	12 bits	750-555			753-555
0/4 ... 20 mA	■		16 bits, configurable	750-563			
0 ... 10 V	■		12 bits	750-550	750-550/000-200		753-550
	■		10 bits, 10 mA	750-560			
		■	12 bits	750-559		750-559/025-000	753-559
± 10 V	■		12 bits	750-556	750-556/000-200		753-556
		■	12 bits	750-557			753-557
0 V / ±10 V	■		16 bits, configurable	750-562			
Exi				See page 175			

Modular I/O-Systems

Function and Technology Modules



750/753 Series Housing Design

Dimensions (mm) W x H x L:	12 x 65 x 100 (Height from upper-edge of DIN-rail)
Connection technology:	CAGE CLAMP®
Conductor sizes:	0.08 ... 2.5 mm ² / 28 ... 14 AWG
Strip length:	750 Series: 8 ... 9 mm / 0.33 in. 753 Series: 9 ... 10 mm / 0.37 in.

750 Series Housing Design, Double Width

Dimensions (mm) W x H x L:	24 x 65 x 100 (Height from upper-edge of DIN-rail)
----------------------------	---

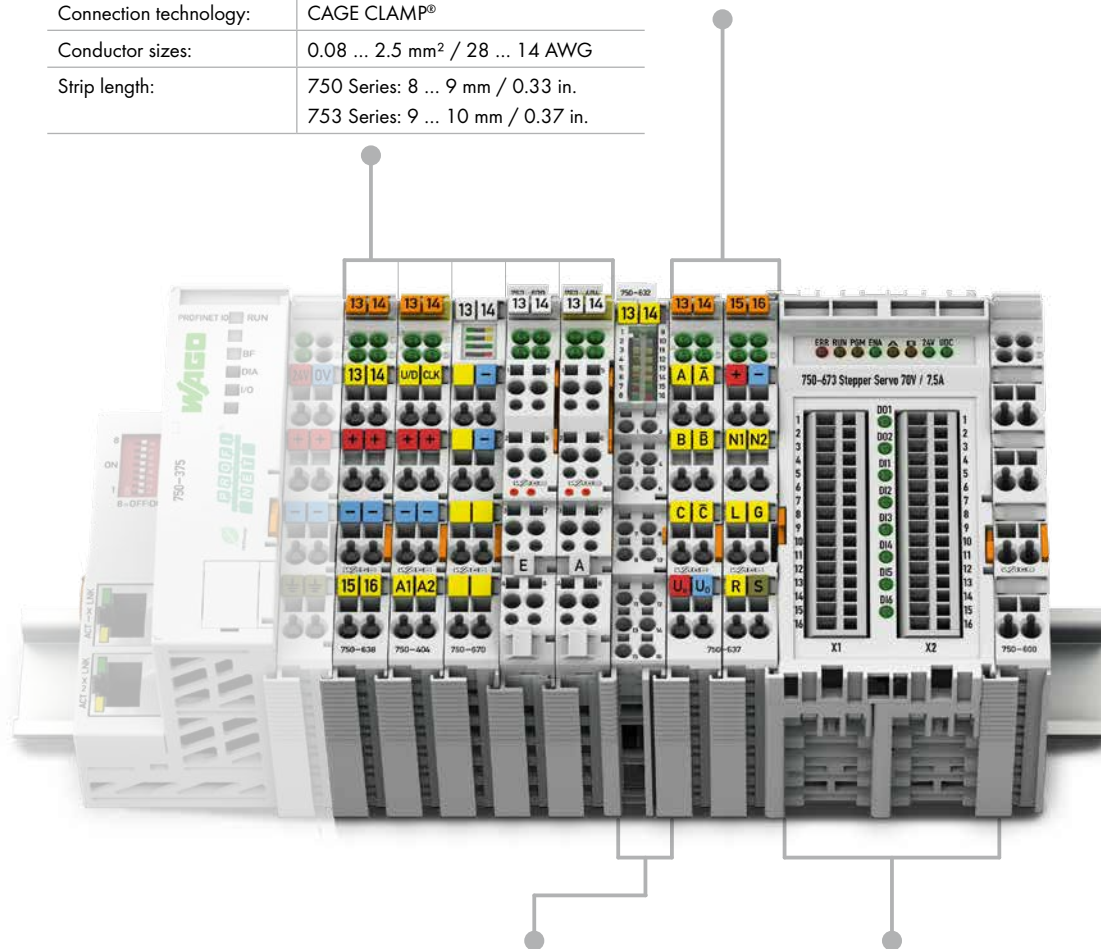

750 Series Housing Design with Push-in CAGE CLAMP® Connections (Up to 16 Connection Points)

Dimensions (mm) W x H x L:	12 x 65 x 100 (Height from upper-edge of DIN-rail)
Connection technology:	Push-in CAGE CLAMP®
Conductor sizes:	solid: 0.08 ... 2.5 mm ² / 28 ... 16 AWG fine-stranded: 0.25 ... 1.5 mm ² / 22 ... 16 AWG
Strip length:	8 ... 9 mm / 0.33 in.

Specialty Housing

Dimensions (mm) W x H x L:	51 x 70 x 100 (Height from upper-edge of DIN-rail)
Connection technology:	CAGE CLAMP®
Conductor sizes:	0.08 ... 1.5 mm ² / 28 ... 14 AWG
Strip length:	5 ... 6 mm / 0.22 in.



Modular I/O-Systems

Function and Technology Modules

750 Series

CAGE CLAMP®
PUSH-IN CAGE CLAMP®

Function	Description	Item No.		
		Standard	/T Operating Temperature: -20 °C ... +60 °C	Pluggable (Connector, Page 178)
Counter Modules	Up/Down Counter, 24 VDC, 100 kHz	750-404		753-404
	Up Counter/Enable Input	750-404/000-001		
	Peak-Time Counter	750-404/000-002		
	Frequency Counter 0.1 Hz ... 100 kHz	750-404/000-003		753-404/000-003
	Up/Down Counter, Switch Output	750-404/000-004		
	2 Up Counters, 16 bits, 5 kHz	750-404/000-005		753-404/000-005
	Up/Down Counter, 24 VDC, 16 bits, 500 Hz	750-638	750-638/025-000	753-638
Pulse Width Output Modules	2-channel pulse width, 24 VDC, short-circuit-protected, high-side switching	750-511		753-511
	2-channel frequency, 2 kHz	750-511/000-001		
	2-channel pulse width, 100 Hz	750-511/000-002		
Distance and Angle Measurement Modules	SSI Transmitter Interface, 24 bits, 125 kHz, gray	750-630		
	SSI Transmitter Interface, 24 bits, 125 kHz, bin.	750-630/000-001		
	SSI Transmitter Interface, 24 bits, 250 kHz, bin.	750-630/000-002		
	SSI Transmitter Interface, 24 bits, 125 kHz, gray, status	750-630/000-004		
	SSI Transmitter Interface, 15 bits, 125 kHz, gray, status	750-630/000-005		
	SSI Transmitter Interface, 24 bits, 250 kHz, gray	750-630/000-006		
	SSI Transmitter Interface, 25 bits, 125 kHz, gray	750-630/000-008		
	SSI Transmitter Interface, 13 bits, 250 kHz, bin.	750-630/000-009		
	SSI Transmitter Interface, 25 bits, 125 kHz, bin.	750-630/000-011		
	SSI Transmitter Interface, 13 bits, 125 kHz, gray	750-630/000-012		
	SSI Transmitter Interface, 29 bits, 125 kHz, bin.	750-630/000-013		
	SSI Transmitter Interface, configurable	750-630/003-000		
	Incremental Encoder Interface	750-631/000-004		
	Incremental Encoder Interface, cam outputs	750-637		
	Incremental Encoder Interface, 24 V, 32 bits, differential	750-637/000-001		
	Incremental Encoder Interface, 24 V, 32 bits, single-ended	750-637/000-002		
	Incremental Encoder Interface, RS-422, 32 bits, single interpreter	750-637/000-003		
	Incremental Encoder Interface, 24 V, 32 bits, single-ended, cam outputs	750-637/000-004		
	Digital Impulse Interface	750-635		753-635
	RTC Module	RTC Module, real-time clock	750-640	
Condition Monitoring	2-Channel, Vibration Velocity/Bearing Condition Monitoring VIB I/O Module	750-645		
Stepper Modules	Stepper Controller, RS-422, 24 V, 20 mA	750-670		
	Stepper Controller, 24 V, 1.5 A	750-671		
	Stepper Controller, 70 V, 7.5 A, 6 IN, 2 OUT	750-672		
	Servo Stepper Controller, 70 V, 7.5 A, 6 IN, 2 OUT	750-673		
DC Drive Controllers	DC Drive Controller, 24 V, 5 A	750-636	750-636/025-000	
	DC Drive Controller, 24 V, 5 A, external motor voltage	750-636/000-700		
	DC Drive Controller, 24 V, 5 A, interference-free	750-636/000-800		
Proportional Valve Module	Proportional Valve Module	750-632		
Ex i		See page 175		

Modular I/O-Systems

Communication Modules



750/753 Series Housing Design

Dimensions (mm) W x H x L:	12 x 65 x 100 (Height from upper-edge of DIN-rail)
Connection technology:	CAGE CLAMP®
Conductor sizes:	0.08 ... 2.5 mm ² / 28 ... 14 AWG
Strip length:	750 Series: 8 ... 9 mm / 0.33 in. 753 Series: 9 ... 10 mm / 0.37 in.

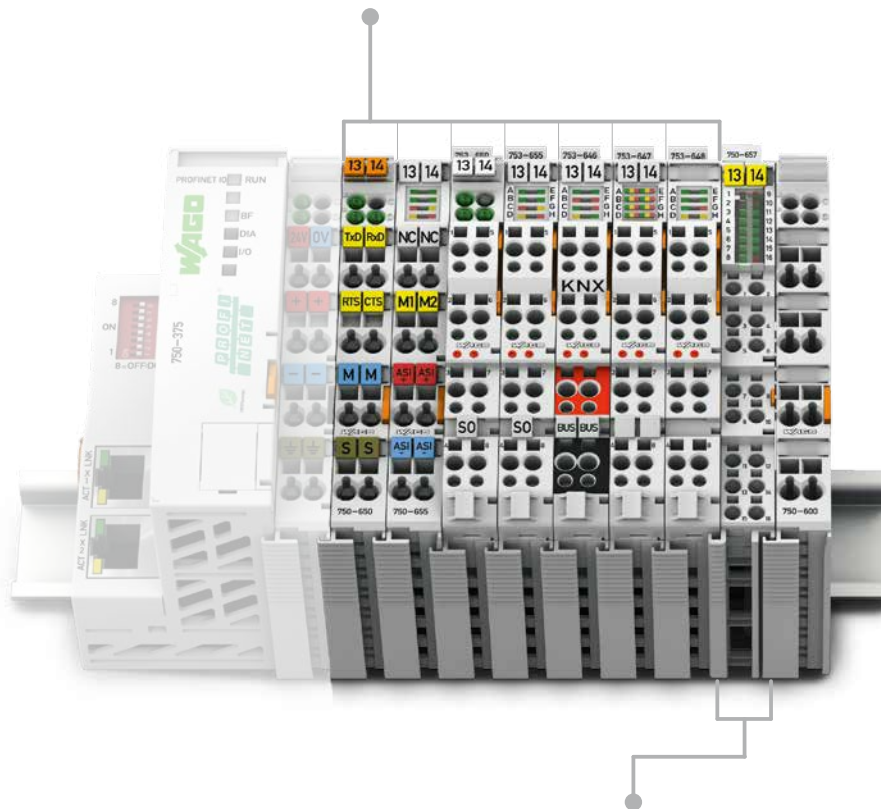

750 Series Housing Design with Push-in CAGE CLAMP® Connections (Up to 16 Connection Points)

Connection technology:	Push-in CAGE CLAMP®
Conductor sizes:	solid: 0.08 ... 2.5 mm ² / 28 ... 16 AWG fine-stranded: 0.25 ... 1.5 mm ² / 22 ... 16 AWG
Strip length:	8 ... 9 mm / 0.33 in.

Modular I/O-Systems

Communication Modules

750 Series

CAGE CLAMP®
PUSH-IN CAGE CLAMP®

Function	Description	Item No.		
		Standard	/T Operating Temperature: -20 °C ... +60 °C	Pluggable (Connector, Page 178)
Serial Interfaces	Serial Interface RS-232 C, 9600, N, 8, 1	750-650		753-650
	Serial Interface RS-232 C, 9600, N, 8, 1, 5 bytes	750-650/000-001		
	Serial Interface RS-232 C, 9600, E, 7, 2	750-650/000-002		
	Serial Interface RS-232 C, 9600, E, 8, 1	750-650/000-006		
	Serial Interface RS-232 C, 19200, N, 8, 1	750-650/000-010		
	Serial Interface RS-232 C, 19200, E, 8, 1	750-650/000-011		
	Serial Interface RS-232 C, 2400, N, 8, 1	750-650/000-012		
	Serial Interface RS-232 C, 4800, E, 8, 1	750-650/000-015		
	Serial Interface RS-232 C, configurable	750-650/003-000		753-650/003-000
	Serial Interface RS-485, 9600, N, 8, 1	750-653	750-653/025-018	753-653
	Serial Interface RS-485, 9600, E, 7, 2	750-653/000-001		
	Serial Interface RS-485, 9600, E, 8, 1	750-653/000-002		
	Serial Interface RS-485, 19200, N, 8, 1, 5 bytes	750-653/000-006		
	Serial Interface RS-485, configurable	750-653/003-000	750-653/025-000	753-653/003-000
	Serial Interface RS-232 C/RS-485	750-652	750-652/025-000	753-652
	TTY Interface, 9600, N, 8, 1	750-651		
	TTY Interface, 9600, E, 8, 1	750-651/000-002		
	Bluetooth®	Bluetooth® RF Transceiver	750-644	
EnOcean	Radio Receiver Module	750-642		
KNX	KNX/EIB/TP1 Module			753-646
DALI	DALI Multi-Master Module			753-647
LON	LON FTT Module			753-648
MP-Bus	MP-Bus Master Module	750-643		
AS-Interface Master	AS-Interface Master	750-655		753-655
IO-Link Master	IO-Link Master	750-657		
CAN Gateway	CAN Gateway	750-658		
Data Exchange	Data Exchange Module	750-654		

6



Modular I/O-Systems

Supply and Segment Modules

750/753 Series Housing Design

Dimensions (mm) W x H x L:	12 x 65 x 100 (Height from upper-edge of DIN-rail)
Connection technology:	CAGE CLAMP®
Conductor sizes:	0.08 ... 2.5 mm ² / 28 ... 14 AWG
Strip length:	750 Series: 8 ... 9 mm / 0.33 in. 753 Series: 9 ... 10 mm / 0.37 in.

750 Series Housing Design with Push-in CAGE CLAMP® Connections (Up to 16 Connection Points)

Connection technology:	Push-in CAGE CLAMP®
Conductor sizes:	solid: 0.08 ... 2.5 mm ² / 28 ... 16 AWG fine-stranded: 0.25 ... 1.5 mm ² / 22 ... 16 AWG
Strip length:	8 ... 9 mm / 0.33 in.

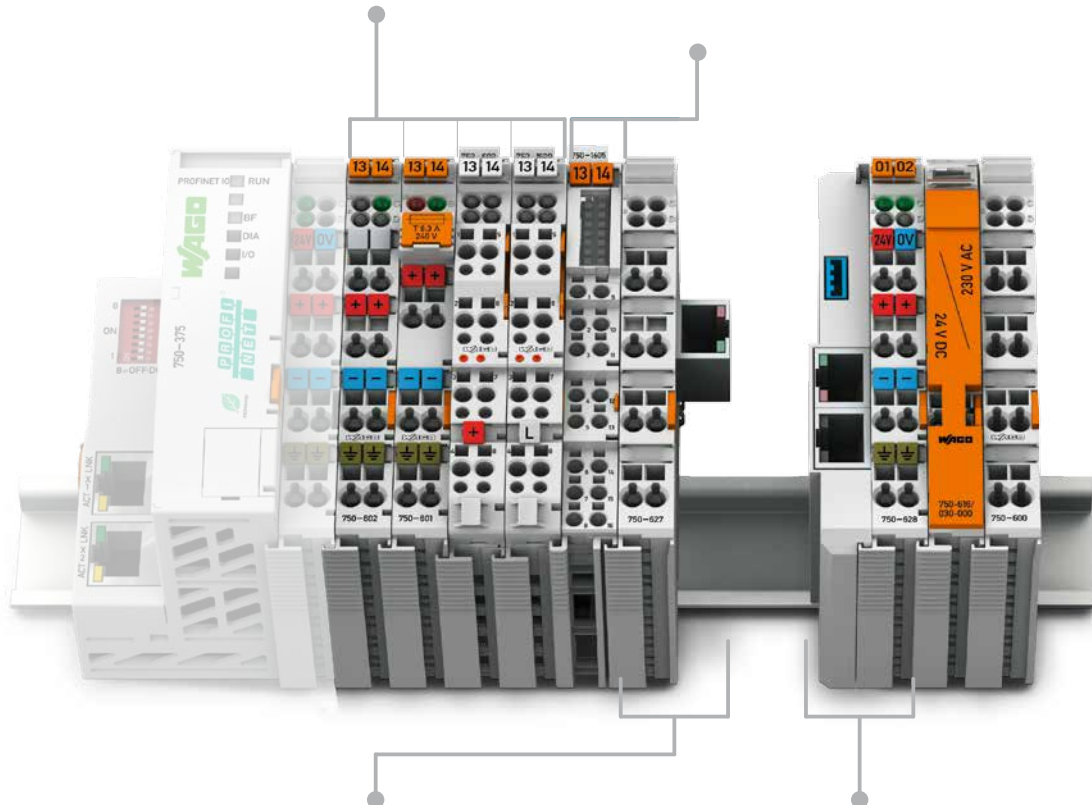

Specialty Housing for Internal Data Bus Extension End Module

Dimensions (mm) W x H x L:	24 x 65 x 100 (Height from upper-edge of DIN-rail)
----------------------------	---

Specialty Housing for Internal Data Bus Extension Coupler Module

Dimensions (mm) W x H x L:	25 x 65 x 100 (Height from upper-edge of DIN-rail)
----------------------------	---



Modular I/O-Systems

Supply and Segment Modules

750 Series

CAGE CLAMP®
PUSH-IN CAGE CLAMP®

Function	Description	Item No.		
		Standard	/T Operating Temperature: -20 °C ... +60 °C	Pluggable (Connector, Page 178)
Supply Modules 24 VDC	24 VDC, passive	750-602	750-602/025-000	753-602
	24 VDC, max. 6.3 A, without diagnostics, with fuse carrier	750-601		
	24 VDC, max. 6.3 A, with diagnostics, with fuse carrier	750-610		
	24 VDC, 5 ... 15 V	750-623		
24 VDC, Passive	24 VDC	750-613		
24 VAC	24 VAC, with fuse carrier	750-617		
120 VAC	120 VAC, max. 6.3 A, without diagnostics, with fuse carrier	750-615		
230 VAC	0 ... 230 V AC/DC, without diagnostics, passive	750-612		753-612
	230 VAC, max. 6.3 A, without diagnostics, with fuse carrier	750-609		
	230 VAC, max. 6.3 A, with diagnostics, with fuse carrier	750-611		
DALI Multi-Master DC/DC Converter	DALI Multi-Master DC/DC Converter			753-620
Field-Side Connection Modules	24 VDC	750-603		753-603
	0 VDC	750-604		753-604
	0 ... 230 V AC/DC	750-614		753-614
	16+, 24 VDC	750-1605		
	16-, 0 VDC	750-1606		
	8+/8-, 24/0 VDC	750-1607		
Filter Modules	Field-Side Power Supply Filter (Surge), high isolation ❶	750-624/020-000		
	Field-Side Power Supply Filter (Surge), high isolation, without power jumper contacts, also suitable as a supply module ❶	750-624/020-001		
	Field-Side Power Supply Filter (Surge) ❸ ❺	750-624		
	Field-Side Power Supply Filter (Surge), without power jumper contacts, also suitable as a supply module ❸ ❺	750-624/000-001		
	Power Supply Filter (Surge), high isolation ❷	750-626/020-000	750-626/025-001	
	Power Supply Filter (Surge) ❹ ❺	750-626	750-626/025-000	
Internal Data Bus Extension	End Module	750-627		
	Coupler Module	750-628		
Spacer Modules	Binary Spacer Module	750-622		
	Spacer Module, active			753-1629
	Spacer Module, active, without power jumper contacts			753-1629/000-001
	Spacer Module, passive			753-629/020-000
Separation Modules	Separation Module	750-616		
	Separation Module, labeled	750-616/030-000		
	Separation Module with Power Jumper Contacts	750-621		
End Modules	End Module for internal data bus completion	750-600	750-600/025-000	
Ex i		See page 175		

- ❶ Required for marine-certified operation with 750 Series I/O Modules
- ❷ Required for marine-certified operation with both 750 Series Couplers and Programmable Controllers
- ❸ Required for marine-certified operation with an Ex i Supply Module
- ❹ Required for marine-certified operation with both 758 Series IPCs and 750-625 Ex i Supply Module
- ❺ Required when using the 750 Series PROFIsafe Modules

Modular I/O-Systems

Functional safety

750 Series

CAGE CLAMP®

Function	Description	Item No.	
		Standard	Pluggable (Connector, Page 178)
PROFIsafe Digital Input Modules	PROFIsafe V1.3, 8 FDI 24 V	750-660/000-001	
	PROFIsafe V2 iPar, 4 FDI 24 V	750-661/000-003	753-661/000-003
	PROFIsafe V2 iPar, 8 FDI 24 V	750-662/000-003	753-662/000-003
PROFIsafe Digital Input/Output Modules	PROFIsafe V1.3, 4 FDO 0.5 A, 4 FDI 24 V	750-665/000-001	
	PROFIsafe V2 iPar, 4 FDI/2 FDO 24 V/2 A	750-666/000-003	753-666/000-003
	PROFIsafe V2 iPar, 4 FDI/4 FDO 24 V/2 A	750-667/000-003	753-667/000-003
Intrinsically Safe Digital Input Module with Inputs for Functional Safety	PROFIsafe V2 iPar, 4 F Ex i DI 24V	750-663/000-003	
Ex i Supply Modules	The intrinsically safe digital input module with inputs for functional safety (750-663/000-003) shall only be operated using an Ex i 24 VDC power supply (e.g., 750-606, 750-625/000-001)! General information (e.g., installation regulations) on explosion protection is available in the WAGO-I/O-SYSTEM 750 manuals!		
	24 VDC 1.0 A Ex i Supply Module, with diagnostics	750-606	
	24 VDC 1.0 A Ex i Supply Module	750-625/000-001	
Filter Modules	The mixed operation of safe and conventional modules streamlines system configuration. For increased electromagnetic immunity (EMC standard), WAGO offers compact power supply filter modules (Section 4.10). Specific power supply features must be considered, which are described in detail in the corresponding manuals.		
	24 VDC Field-Side Power Supply Filter (Surge), high isolation	750-624/020-000	
	24 VDC Power Supply Filter (Surge), high isolation	750-626/020-000	



Modular I/O-Systems

Intrinsically Safe Ex i Modules

750 Series

CAGE CLAMP®

Function	Description	Item No.
Ex i Supply Modules	24 VDC 1.0 A Ex i Supply Module, with diagnostics	750-606
	24 VDC 1.0 A Ex i Supply Module	750-625/000-001
Digital Input Ex i Modules for Proximity Switches per EN 60947-5-6	1 DI NAMUR, Ex i	750-435
	2 DI NAMUR, Ex i	750-438
	8 DI NAMUR, Ex i	750-439
Intrinsically Safe Digital Input Module with Inputs for Functional Safety	PROFIsafe V2 iPar, 4 F Ex i DI 24V	750-663/000-003
Digital Output Ex i Modules	2 DO Ex i, short-circuit-protected, high-side switching	750-535
	2 DO Relay Output Ex i Module, isolated outputs, 2 changeover contacts	750-538
Analog Input Ex i Modules	2 AI Ex i 4 ... 20 mA, single-ended	750-485
	2 AI Ex i 4 ... 20 mA, single-ended, HART	750-484
	2 AI Ex i RTD	750-481/003-000
	2 AI Ex i TC	750-487/003-000
Analog Output Ex i Modules	2 AO Ex i 0 ... 20 mA	750-585
	2 AO Ex i 4 ... 20 mA	750-586
Ex i Function Module	Ex i Up/Down Counter NAMUR, 50 kHz	750-633

6

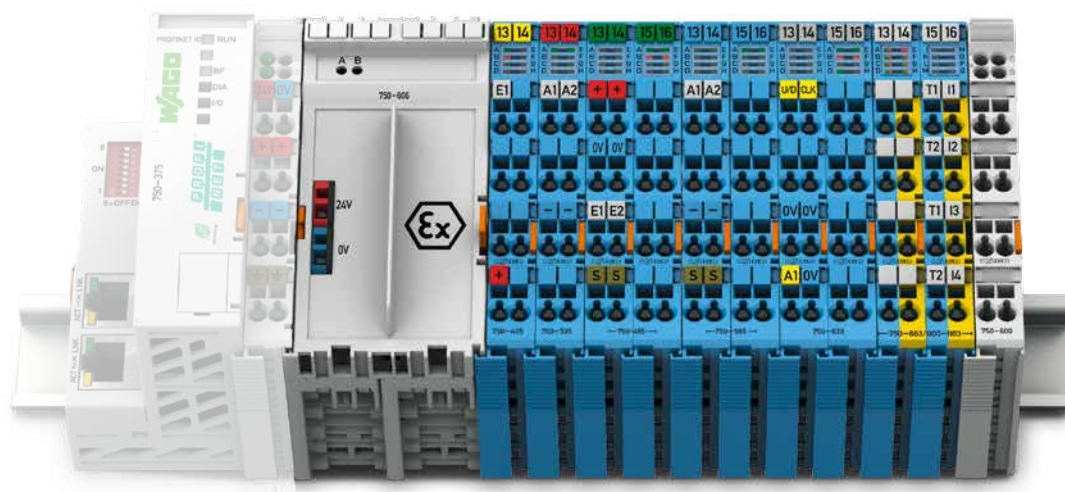

WAGO-I/O-SYSTEM – 750 XTR Series

General Product Information



Taking it to the eXTReme – The standard for 750 XTR

Instantly recognizable by its dark gray modules, the WAGO-I/O-SYSTEM 750 XTR's unique features make it ideal for extreme environments or applications.

The WAGO-I/O-SYSTEM 750 XTR features outstanding characteristics: It is extremely temperature-resistant, immune to interferences, as well as insensitive to vibrations and impulse voltages. This is what makes 750 XTR the first choice for demanding applications including:

- Marine systems and onshore/offshore installations
- Renewable energy systems (wind, photovoltaic and biogas plants)
- Transformer stations and power distribution
- Petrochemical Industry
- Water and wastewater treatment systems
- Custom machine engineering
- Railway applications



eXTReme temperatures

-40 °C ... +70 °C

eXTReme isolation

up to 5 kV of impulse voltage

DIN EN 60870-2-1

eXTReme vibrations

up to 5g acceleration

DIN EN 60068-2-6

General Specifications

Operating voltage	24 VDC Under laboratory conditions +15 °C ... +35 °C: 18 ... 31.2 V (17.4 ... 31.2 V) ¹⁾ -40 °C ... +55 °C: 18 ... 28.8 V (17.4 ... 28.8 V) ¹⁾ +55 °C ... +70 °C: 18 ... 26.4 V (17.4 ... 26.4 V) ¹⁾ ¹⁾ including residual ripple of 15 %
Operating temperature	-40 °C ... +70 °C
Storage temperature	-40 °C ... +85 °C
Relative humidity	Max. 95 % short-term condensation per IEC EN 60721-3-3, Class 3K7 (excluding wind-driven precipitation, water and ice formation)
Operating altitude	without temperature derating: 0 ... 2,000 m; with temperature derating: 2,000 ... 5,000 m (0.5 K/100 m); max.: 5,000 m
Pollution degree	2 per IEC 61131-2
Immunity to impulse voltages	Per EN 60870-2-1 Modules ≤ 50 V: 510 VAC / 775 VDC; Modules > 50 V: 2.5 kVAC / 3.5 VDC Isolation: Rated impulse voltage Modules ≤ 50 V: 1 kV (Class VW1 per EN 60870-2-1) Modules > 50 V: 5 kV (Class VW3 per EN 60870-2-1) Surge: Modules ≤ 50 V: 1 kV (L - L) / 2 kV (L - E) Modules > 50 V: 2 kV (L - L) / 4 kV (L - E) Overvoltage category: III
Vibration resistance	5g per IEC 60068-2-6, EN 60870-2-2, IEC 60721-3-1, IEC 60721-3-3, EN 61131-2
Shock resistance	15g/11 ms/halfsine/1,000 shocks per IEC 60068-2-27 25g/6 ms/1,000 shocks per IEC 60068-2-27
EMC immunity to interference	EN 61000-6-1, EN 61000-6-2, EN 61131-2 marine applications, EN 50121-3-2, EN 50121-4 EN 50121-5, EN 60255-26, EN 60870-2-1 EN 61850-3, IEC 61000-6-5, IEEE 1613, VDEW: 1994
EMC emission of interference	EN 61000-6-3 and EN 61000-6-4, EN 61131-2 EN 60255-26, marine applications EN 60870-2-1 (industrial and residential areas) EN 61850-3 (industrial and residential areas) EN 50121-3-2, EN 50121-4, EN 50121-5
Protection type	IP20
Mounting position	Horizontal (standing/lying) or vertical
Mounting type	on DIN-35 rail
Housing material	polycarbonate, polyamide 6.6
Exposure to pollutants	per IEC 60068-2-42 and IEC 60068-2-43
Maximum pollutant concentration with a relative humidity < 75 %	SO ₂ ≤ 25 ppm; H ₂ S ≤ 10 ppm
Connection technology	CAGE CLAMP® (for standard I/O modules and fieldbus couplers)
Conductor size; strip length for standard I/O modules and fieldbus couplers: ECO Fieldbus Couplers:	0.25 ... 2.5 mm ² /24 ... 14 AWG; 8 ... 9 mm/0.33 in. 0.25 ... 1.5 mm ² /24 ... 16 AWG; 5 ... 6 mm/0.22 in.
Connection technology	Push-in CAGE CLAMP® (for I/O modules with 16 connection points)
Conductor size; strip length for I/O modules with 16 connection points:	0.25 ... 1.5 mm ² /24 ... 16 AWG; 8 ... 9 mm/0.33 in.
Current via power jumper contacts	10 A (max.)

- No air conditioning required
 - Compact footprint
 - Lower energy and maintenance costs
- Can be used in unshielded areas
- Maximum system uptime
- Install close to vibrating and shock-generating system components
- CAGE CLAMP® connection technology for vibration-proof, fast and maintenance-free connections

Modular I/O-Systems

750 XTR Series









CAGE CLAMP®
PUSH-IN CAGE CLAMP®

	Description	Item No.
	PFC200 CS 2ETH RS CAN DPS / XTR	750-8206/040-000
	PFC200 CS 2ETH RS CAN DPS TELE / XTR	750-8206/040-001
	PFC200 CS 2ETH RS / XTR	750-8202/040-000
	PFC200 CS 2 ETH RS TELE / XTR	750-8202/040-001
	ETHERNET Controller / XTR	750-880/040-000
	ETHERNET Controller TELE / XTR	750-880/040-001
	CANopen Controller / XTR	750-838/040-000
	PROFIBUS DP/V1 12 Mbd / XTR	750-333/040-000
	ETHERNET / XTR	750-352/040-000
	CANopen D-Sub / XTR	750-338/040-000
	8 DI 24 VDC 3.0 ms, 2-wire connection / XTR	750-1415/040-000
	8 DI 24 VDC 0.2 ms, 2-wire connection / XTR	750-1416/040-000
	16 DI 24 VDC 3.0 ms / XTR	750-1405/040-000
	2 DI 220 VDC 3.0 ms / XTR	750-407/040-000
	2 DI 60 VDC 3.0 ms / XTR	750-429/040-001
	2 DI 110 VDC 3.0 ms / XTR	750-427/040-000
	2 DO 24 VDC 2.0 A, diagnostics / XTR	750-508/040-000
	8 DO 24 VDC 0.5 A, 2-wire connection / XTR	750-1515/040-000
	2 DO 230 VAC 1.0 A, relay 2 CO, potential-free / XTR	750-517/040-000
	4 AI 0 ... 20 mA, single-ended / XTR	750-453/040-000
	4 AI 4 ... 20 mA, single-ended / XTR	750-455/040-000
	2 AI 4 ... 20 mA, differential input NE43 / XTR	750-492/040-001
	4 AI 0 ... 10 VDC, single-ended / XTR	750-468/040-000
	4 AI ±10 VDC, single-ended / XTR	750-457/040-000
	2/4 AI RTD, configurable / XTR	750-464/040-000
	2 AI Thermocouple, configurable / XTR	750-469/040-000
	3-Phase Power Measurement Module, 690 V, 1 A / XTR	750-495/040-000
	3-Phase Power Measurement Module, 690 V, 5 A / XTR	750-495/040-001
	3-Phase Power Measurement Module, 690 V, Rogowski coil / XTR	750-495/040-002
	2 AO 0/4 ... 20 mA / 6 ... 18 VDC, configurable / XTR	750-563/040-000
	4 AO ±10 VDC / XTR	750-557/040-000
	4 AO 0 ... 10 VDC / XTR	750-559/040-000
	RS-232/RS-485, configurable / XTR	750-652/040-000
	24 VDC Power Supply / XTR	750-602/040-000
	AC/DC Power Supply, 0 ... 230 V / XTR	750-612/040-000
	24 VDC Bus Power Supply	750-613/040-000
	24 VDC Field-Side Power Supply Filter (Surge) / XTR	750-624/040-001
	24 VDC Power Supply Filter (Surge) / XTR	750-626/040-000
	Field-Side Connection Module 16+ / XTR	750-1605/040-000
	Field-Side Connection Module 16- / XTR	750-1606/040-000
	Separation Module / XTR	750-616/040-000
	End Module / XTR	750-600/040-000

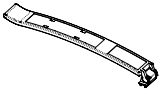
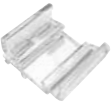
Modular I/O-Systems

Accessories

750/753 Series

	Description	Item No.	Pack. Unit
	Pluggable Connector, 753 Series, light gray	753-110	25
	Pluggable Connector, 753 Series, yellow	753-120	25
	Coding Elements, 753 Series, red	753-150	100
	Marker Carrier for 750/753 Series, transparent	750-103	50
	Marker Carrier for 750/753 Series, 4 LEDs	750-106	50
	Marker Carrier for 750/753 Series, 8 LEDs	750-107	50
	Markers for Group Marker Carrier, white	750-100	1 sheet
	Miniature WSB Quick Marking System, plain ○ white ● yellow ● red ● blue ● gray ● orange ● light green ● green ● violet	248-501 248-501/000-002 248-501/000-005 248-501/000-006 248-501/000-007 248-501/000-012 248-501/000-017 248-501/000-023 248-501/000-024	5 cards
	Interface modules for system wiring, relay modules with miniature switching relay, with flat cable connector per DIN 41651 8 channels/10 poles 16 channels/20 poles	See pages 232-234	1
	WAGO Ribbon Cables, connect I/O modules to interface modules 20/20 20/2 x 10	706-3057/300-100 706-7753/302-000	1
	Operating Tools		
	with a partially insulated shaft, type 1, (2.5 x 0.4) mm blade	210-719	1
	with a partially insulated shaft, type 2, (3.5 x 0.5) mm blade	210-720	1

Modular I/O-Systems

Accessories

750/753 Series

	Description	Item No.	Pack. Unit	
	PROFIBUS Fieldbus Connector with D-sub connector, 9-pole, suitable for an S7 PLC	750-971	1	
	PROFIBUS Fieldbus Connector with D-sub male and female connectors, 9-pole	750-972	1	
	ETHERNET RJ-45 Fieldbus Connector, IP20, CAT 5e	750-975	1	
	PROFINET RJ-45 Fieldbus Connector, IP20	750-976	1	
	PROFIBUS Fieldbus Connector with D-sub male connector, 9-pole	750-960	1	
	CANopen Fieldbus Connector with D-sub female connector, 9-pole	750-963	1	
	INTERBUS Fieldbus Connector (IN) with D-sub female connector, 9-pole	750-961	1	
	INTERBUS Fieldbus Connector (OUT) with D-sub male connector, 9-pole	750-962	1	
	CC-Link Fieldbus Connector with D-sub male connector, 9-pole	750-965	1	
	<i>Bluetooth</i> [®] Adapter, radio connection between PC and coupler/controller	750-921	1	
	WAGO USB Communication Cable, connection between PC and coupler/controller (suitable for <i>JUMPFLEX</i> [®])	2.5 m 5 m	750-923 750-923/000-001	1
	<i>Bluetooth</i> [®] ETHERNET Gateway		758-915	1
	WLAN ETHERNET Gateway	2.4 GHz 5 GHz	758-916 758-917	1
	Magnetic-Mount Antenna, GSM 900/1800		758-910	1
	Magnetic-Mount Antenna, WLAN/ <i>Bluetooth</i> [®] 2.4 Ghz		758-912	1

WAGO SPEEDWAY 767

For Cabinet-Free Data Acquisition

Where previously discrete wiring was once required, fieldbuses now communicate between the control and field levels. Depending on the application, cabinet-free automation systems help minimize costs for planning, start-up and maintenance.

In addition to requiring a high degree of protection, a robust design and standardized connection technology, there is an increasing demand for advanced IP67 features that were once reserved only for IP20 systems, including:

- Real-time capable (isochronous data acquisition/output)
- Parameterizable
- Diagnostic capable
- Upgradable

Connect the cabinet directly to the field level without sacrificing functionality – *SPEEDWAY* perfectly tailors machines to meet specific, decentralized needs. Configuration is both easy and flexible, with changes being made safely and quickly (plug & play).

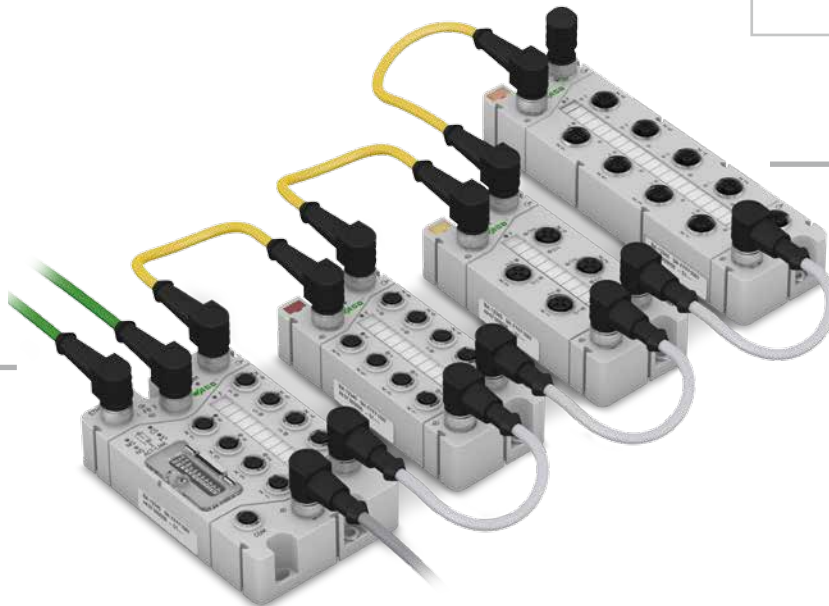



- Fully encapsulated for harsh environmental conditions
- Fieldbus-independent – Support all standard fieldbus protocols and ETHERNET standards
- Real-time capability up to isochronous mode for selected ETHERNET-based fieldbuses
- Exclusive use of standard pluggable connectors
- Flexible mounting options
- ATEX/IEC Ex certificate for Zone 2/22







General Specifications

Operating voltage	24 VDC (-25 % ... +30 %)
Operating temperature	-25 °C ... +60 °C; temperature change 3 K/s
Storage temperature	-40 °C ... +85 °C
Relative humidity (without condensation)	5 ... 95 %
Operating altitude	-1000 ... 2000 m; Air pressure: 1080 ... 795 hPa
Altitude at storage/transport	-1000 ... 3500 m; Air pressure: 1080 ... 660 hPa
Free fall	≤ 1 m per EN 61131-2
Pollution degree	3 per IEC 60664 (IEC 61131)
Protection class	III per IEC 60536 (VDE 0106, Part 1)
Vibration resistance	5g per IEC 60068-2-6
Shock resistance	Short-term: 50g/11 ms/half-sine per IEC 60068-2-27 Long-term: 30g/6 ms/half-sine per IEC 60068-2-29
EMC immunity to interference	EN 61000-6-2
EMC emission of interference	EN 61000-6-4
Protection type	IP67 (NEMA 6&6P) per DIN 40050 (EN 60529)
Mounting position	any
Housing material	Polyamide (PA), light gray (RAL7035); Makrolon (address switch cover), transparent; Flammability per UL94-V0; halogen, silicon-free; Potting: Polyurethane (PUR), halogen/silicon-free
UV resistance	1,000 h UV continuous light per DIN EN ISO 4892-2B
Maximum contaminant concentration	SO ₂ < 0.5 ppm; H ₂ S < 0.1 ppm
Current carrying capacity (supply connections)	Max. 8 A (U _{IS} : 4 A; U _A : 4 A)

WAGO SPEEDWAY 767

	Function	Description	Item No.	
			Standard	Interference-Free
	Fieldbus Couplers	FC PROFIBUS DP, 8 DI, 24 VDC	767-1101	
		FC PROFINET IO, 8 DI, 24 VDC	767-1201	
		FC ETHERNET, 8 DI, 24 VDC	767-1301	
		FC sercos 8 DI, 24 VDC, high-speed	767-1311	
		FC DeviceNet, 8 DI, 24 VDC	767-1401	
		FC CANopen, 8 DI, 24 VDC	767-1501	
	Digital Input Modules (DI)	8 DI, 24 VDC (8 x M8)	767-3801	
		8 DI, 24 VDC (4 x M12)	767-3802	
		8 DI, 24 VDC, low-side switching (8 x M8)	767-3803	
		8 DI, 24 VDC, low-side switching (4 x M12)	767-3804	
		8 DI, 24 VDC (8 x M12)	767-3805	
		8 DI, 24 VDC, high-speed (4 x M12)	767-3806	
	Digital Output Modules (DO)	8 DO, 24 VDC, 0.5 A (8 x M8)	767-4801	767-4801/000-800
		8 DO, 24 VDC, 0.5 A (4 x M12)	767-4802	767-4802/000-800
		8 DO, 24 VDC, 2.0 A (8 x M8)	767-4803	767-4803/000-800
		8 DO, 24 VDC, 2.0 A (4 x M12)	767-4804	767-4804/000-800
		8 DO, 24 VDC, 0.5 A, low-side switching (8 x M8)	767-4805	
		8 DO, 24 VDC, 0.5 A, low-side switching (4 x M12)	767-4806	
		8 DO, 24 VDC, 0.5 A (8 x M12)	767-4807	767-4807/000-800
		8 DO, 24 VDC, 0.1 A, high-speed (4 x M12)	767-4808	
	Digital Input/Output Modules (DIO)	8 DIO, 24 VDC, 0.5 A (8 x M8)	767-5801	767-5801/000-800
		8 DIO, 24 VDC, 0.5 A (4 x M12)	767-5802	767-5802/000-800
		8 DIO, 24 VDC, 0.5 A (8 x M12)	767-5803	767-5803/000-800
		4 DIO, 24 VDC, 0.2 A, high-speed (4 x M12)	767-5401	
	Analog Input Modules (AI)	4 AI U/I (4 x M12)	767-6401	
		4 AI RTD (4 x M12)	767-6402	
		4 AI TC (4 x M12)	767-6403	
	Analog Output Modules (AO)	4 AO U/I (4 x M12)	767-7401	
	Function and Technology Modules	TTL Incremental Encoder/SSI Encoder (4 x M12)	767-5201	
		HTL Incremental Encoder/Counter (4 x M12)	767-5202	
	Communication Modules	Serial Interface RS-232, RS-422/-485 (4 x M12)	767-5203	
		MOVILINK® Interface (RS-232, RS-485) (4 x M12)	767-5204	
	Supply Modules	Power Divider (1 x M23 + 6 x M12)	767-9101	



Accessories

	Spacer Module, with fixing lugs for cable ties		767-111	
	Protective Caps, for unused sockets	M8	756-8101	
		M12	756-8102	
	Protective Caps, for unused plugs	M12	755-8103	
		M23	755-8104	
	Carrier Rail Adapter	for couplers	767-121	
		for I/O modules	767-122	
			767-125	
	USB Communication Cable	3 m	756-4101/042-030	
	Profile Adapter	for couplers	767-123	
		for I/O modules and power dividers	767-124	
			767-126	



WAGO SPEEDWAY 767

Connection Cables for 767 Series



System Bus Cables, B-Coded

	Description	Item No.
	Socket, straight, 2 ... 20 m	756-1301/060-020 ... 756-1301/060-200
	Plug, straight, 2 ... 20 m	756-1303/060-020 ... 756-1303/060-200
	Socket/plug, straight, 0.2 ... 50 m	756-1305/060-002 ... 756-1305/060-500
	Socket, angled, 2 ... 20 m	756-1302/060-020 ... 756-1302/060-200
	Plug, angled, 2 ... 20 m	756-1304/060-020 ... 756-1304/060-200
	Socket/plug, angled, 0.2 ... 50 m	756-1306/060-002 ... 756-1306/060-500

Power Supply Cables, A-Coded

	Description	Item No.
	Socket, straight, 2 ... 20 m	756-3101/040-020 ... 756-3101/040-200
	Plug, straight, 2 ... 20 m	756-3103/040-020 ... 756-3103/040-200
	Socket/plug, straight, 0.2 ... 20 m	756-3105/040-002 ... 756-3105/040-200
	Socket, angled, 2 ... 20 m	756-3102/040-020 ... 756-3102/040-200
	Plug, angled, 2 ... 20 m	756-3104/040-020 ... 756-3104/040-200
	Socket/plug, angled, 0.2 ... 20 m	756-3106/040-002 ... 756-3106/040-200

ETHERNET, PROFINET Cables, D-Coded

	Description	Item No.
	Plug, straight, 2 ... 20 m	756-1201/060-020 ... 756-1201/060-200
	Plug/plug, straight, 2 ... 20 m	756-1203/060-020 ... 756-1203/060-200
	Plug, angled, 2 ... 20 m	756-1202/060-020 ... 756-1202/060-200
	Plug/plug, angled, 2 ... 20 m	756-1204/060-020 ... 756-1204/060-200

Power Supply

The WAGO SPEEDWAY system's modular structure allows both individual I/O modules and groups of modules to be supplied (e.g., emergency stop groups). Thus, different power supplies can be used at the same potential to operate each individual module and group of modules. Two supply lines are routed within the supply cables (gray). The logic and sensor supply (U_{IS}) is always electrically isolated from the actuator supply (U_A).

Additional I/O modules can be connected until the highest permissible current load of 4 A for one supply line (U_{IS} and/or U_A) is reached. The power supply must be re-established to connect additional SPEEDWAY Modules. However, using 2 A output modules, power supply will not be transmitted in the event of an increased power demand.

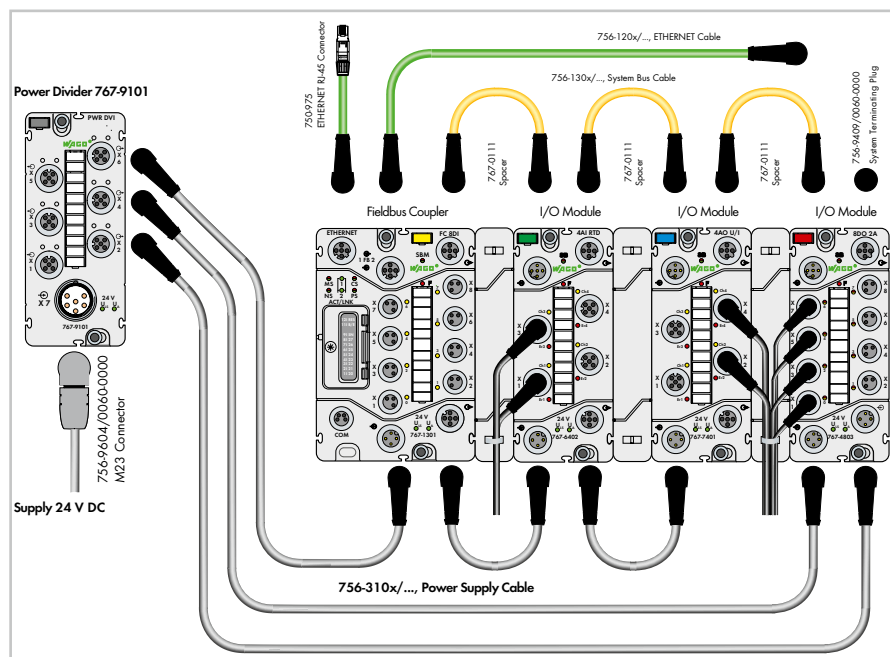

WAGO's SPEEDWAY Power Divider permits U_{IS} and U_A power supply distribution via six M12 connectors. The combination of point-to-point and linear power distribution/distribution routing offers the greatest flexibility to optimize the supply lines for the respective application and to supply power over large distances.

Sensor/Actuator Boxes, IP67 757 Series

	Function	Description	Item No.
	M12 Sensor/Actuator Boxes, with connection cable	4-port, 4-pole, 5 m cable	757-244/000-005
		4-port, 4-pole, 10 m cable	757-244/000-010
		6-port, 4-pole, 5 m cable	757-264/000-005
		6-port, 4-pole, 10 m cable	757-264/000-010
		8-port, 4-pole, 5 m cable	757-284/000-005
		8-port, 4-pole, 10 m cable	757-284/000-010
		8-port, 4-pole, 25 m cable	757-284/000-025
		4-port, 5-pole, 5 m cable	757-245/000-005
		4-port, 5-pole, 10 m cable	757-245/000-010
		6-port, 5-pole, 5 m cable	757-265/000-005
		6-port, 5-pole, 10 m cable	757-265/000-010
		8-port, 5-pole, 5 m cable	757-285/000-005
		8-port, 5-pole, 10 m cable	757-285/000-010
		8-port, 5-pole, 25 m cable	757-285/000-025
	M12 Sensor/Actuator Boxes, with M23 connector	4-port, 4-pole, M23 connector	757-144
		6-port, 4-pole, M23 connector	757-164
		8-port, 4-pole, M23 connector	757-184
		4-port, 5-pole, M23 connector	757-145
		6-port, 5-pole, M23 connector	757-165
		8-port, 5-pole, M23 connector	757-185
		8-port, 5-pole, without LED, M23 connector	757-185/100-000
	M8 Sensor/Actuator Boxes, with connection cable	4-port, 3-pole, 2 m cable	757-443/000-002
		4-port, 3-pole, 5 m cable	757-443/000-005
		4-port, 3-pole, 10 m cable	757-443/000-010
		6-port, 3-pole, 5 m cable	757-463/000-005
		6-port, 3-pole, 10 m cable	757-463/000-010
		8-port, 3-pole, 5 m cable	757-483/000-005
		8-port, 3-pole, 10 m cable	757-483/000-010
		10-port, 3-pole, 5 m cable	757-403/000-005
10-port, 3-pole, 10 m cable	757-403/000-010		
	M8 Sensor/Actuator Boxes, with M16 connector	4-port, 3-pole, M16 connector	757-343
		6-port, 3-pole, M16 connector	757-363
		8-port, 3-pole, M16 connector	757-383
		10-port, 3-pole, M16 connector	757-303
Accessories			
	Connection Cables	M16 socket, straight, 14-pole, 5 ... 15 m	756-3205/140-050 ... 756-3205/140-150
		M16 socket, angled, 14-pole, 5 ... 15 m	756-3206/140-050 ... 756-3206/140-150
		M23 socket, straight, 12-pole, 5 ... 15 m	756-3201/120-050 ... 756-3201/120-150
		M23 socket, straight, 19-pole, 5 ... 15 m	756-3203/190-050 ... 756-3203/190-150
		M23 socket, angled, 12-pole, 5 ... 15 m	756-3202/120-050 ... 756-3202/120-150
		M23 socket, angled, 19-pole, 5 ... 15 m	756-3204/190-050 ... 756-3204/190-150
	Spacer Modules for sensor/actuator boxes	4-port	757-040
		6-port	757-060
		8-port	757-080
		10-port	757-000
	Marker Cards for M12 sensor/actuator boxes, 40 markers/card		757-011

ETHERNET Industrial Switches

852 Series

Industrial Switch, 5 Ports*
Supply voltage: 9 ... 48 VDC
Ports: 5 x 10/100Base-TX (RJ-45)

Dimensions (W x H x L): 50 x 120 x 105 mm



Industrial Switches, 8 Ports*
Supply voltage: 9 ... 48 VDC
Ports: 8 x 10/100Base-TX (RJ-45)
2 x SFP 100Base-FX Fiber
8 x 1000Base-T

Dimensions (W x H x L): 50 x 162 x 120 mm



Industrial Managed Switch, 8 Ports*
Supply voltage: 12 ... 60 VDC
Ports: 8 x 10/100Base-TX (RJ-45)
2 x SFP 1000Base-SX/LX Fiber

Dimensions (W x H x L): 50 x 162 x 120 mm



Designation	Item No.	Designation	Item No.	Designation	Item No.
Industrial Switch, 5 Ports 100Base-TX	852-101	Industrial Switch, 8 Ports 100Base-TX	852-102	Industrial Managed Switch, 8 Ports 100Base-TX,	
		8 Ports 1000Base-T	852-1102	2 Slots 1000Base-SX/LX	852-303
		Industrial Switch, 8 Ports 100Base-TX,			
		2 Slots 100Base-FX	852-103		
		Extended temperature range: -40 °C ... +70 °C	852-103/040-000		

Accessories, 852 Series

DNV Mounting Adapter,

for ETHERNET Switches, stainless
steel

852-9101



SFP Modules, 1,310 nm, 100Base-FX Multi-Mode LC

2 km 852-201/107-002
30 km 852-201/107-030
2 km (Operating temp.: -40 °C ...
+70 °C) 852-201/040-002



SFP Modules, 1000Base, operating temperature:

-40 °C ... +85 °C
1000Base-SX, 0.5 km 852-1200
1000Base-LX, 10 km 852-1210
1000Base-ZX, 80 km 852-1280



Industrial Managed Switch, 8 Ports*
Supply voltage: 12 ... 60 VDC
Ports: 8 x 10/100/1000Base-TX (RJ-45)
4 x SFP 1000Base-SX/LX Fiber

Dimensions (W x H x L): 50 x 162 x 120 mm



Industrial ECO Switches, 5 Ports*
Supply voltage: 18 ... 30 VDC
Ports: 5 (RJ-45)

Dimensions (W x H x L):
23.4 x 73.8 x 109.2 mm



Industrial ECO Switch, 8 Ports*
Supply voltage: 18 ... 30 VDC
Ports: 8 x 10/100Base-TX (RJ-45)
8 x 1000Base-T

Dimensions (W x H x L):
109.2 x 23.4 x 73.8 mm



Designation	Item No.	Designation	Item No.	Designation	Item No.
Industrial Managed Switch, 8 Ports 1000Base-TX, 4 Slots 1000Base-SX/LX	852-1305	Industrial ECO Switch, 5 Ports 100Base-TX	852-111	Industrial ECO Switch, 8 Ports 100Base-TX	852-112
		Industrial ECO Switch, 5 Ports 1000Base-T	852-1111	Industrial ECO Switch, 8 Ports 1000Base-T	852-1112

* Approvals and technical data are available online at www.wago.com.

For technical explanations and abbreviations, see technical section.

Shield Connecting System

790 Series



Direct installation on metal plate (max. 3 mm thick)



Installation on specialty slotted carrier rail



Installation on busbar with insulated mounting feet



Installation on U-shaped copper busbar



790 Series



790 Series



Mounting the shield clamping saddle onto the busbar.

Shield Clamping Saddles

Saddle Width	Cable Diameter	Item No.	Pack. Unit	Saddle Width	Cable Diameter	Item No.	Pack. Unit
11 mm	0 ... 8	790-108	50	12.4 mm	3 ... 8	790-208	50
19 mm	7 ... 16	790-116	50	21.8 mm	6 ... 16	790-216	25
27 mm	6 ... 24	790-124	50	30 mm	6 ... 20	790-220	25
43 mm	22 ... 40	790-140	50				



Removing the busbar carrier.

Accessories, 790 Series

	Carrier with grounding foot, 45 mm bar 90° to the rail, copper (10 x 3) mm	790-113	25
	Carrier with grounding foot, bar parallel to the rail, copper (10 x 3) mm, 25 mm	790-112	25
	copper (10 x 3) mm, 45 mm	790-114	25
	Carrier with 2 grounding feet, 125 mm bar parallel to the rail, copper (10 x 3) mm	790-115	25
	Carrier rail, specialty slotted, 1,000 mm long, tin-plated (special lengths upon request)	790-145	1
	Spacer sleeve, for specialty slotted carrier rail, for M5-size screw	790-144	200 (2x100)
	Straight busbar, tin-plated, 1,000 mm copper (10 x 3) mm	210-133	20 (20x1)
	30 mm	790-133	20 (20x1)
	50 mm	790-134	20 (20x1)
	Insulated mounting foot, for busbar with M4 x 8 mm screw	790-100	50 (2x25)
	with (3.5 x 9) mm sheet metal screw	790-101	50 (2x25)
	U-shaped busbar, for 750 Series I/O Modules, copper (10 x 3) mm for 5 I/O	790-190	25 (5x5)
	for 8 I/O	790-191	25 (1x25)
	Busbar carrier, for (10 x 3) mm copper busbars, straight	790-300	10
	angled	790-301	10
	Busbar carrier with T-connector, flexible, for (10 x 3) mm copper busbars from center of DIN-rail from upper-edge of DIN-rail		
	70 mm	15 ... 52 mm	790-350/790-398 12
	70 mm	15 ... 92 mm	790-352/790-398 12
	85 mm	15 ... 52 mm	790-360/790-398 12
	85 mm	15 ... 92 mm	790-362/790-398 12
	T-connector, connects two (10 x 3) mm copper busbars	790-398	10
	Shield termination, includes cable tie for 5 ... 10 mm Ø, 55 mm long	709-350	100 (4x25)
	150 mm long	709-352	100 (4x25)

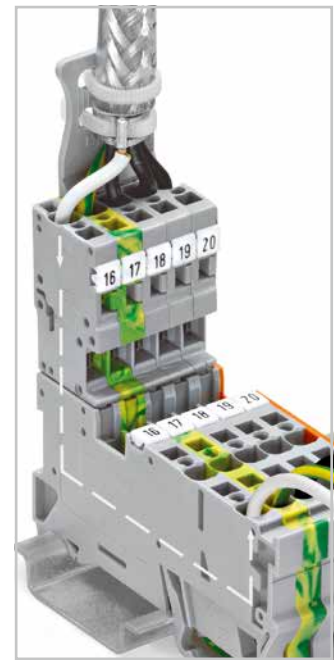

Shield termination

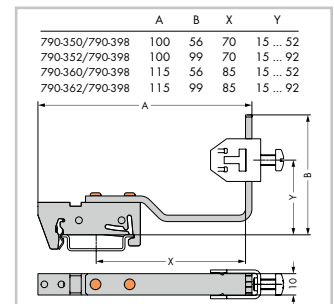

Overview: Dimensions of flexible busbar carriers

Negative Shield Attenuation

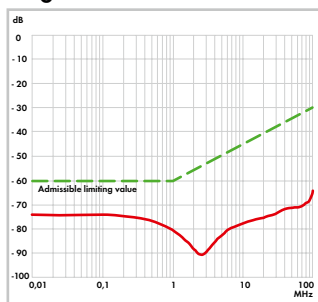

WAGO's shield connecting system is highly effective because the clamping unit can be brought very close to the unshielded part of the cable. Additionally, the spring material is part of the clamping saddle, providing a good electrical connection (the system also acts as partial strain relief).

The spring element integrated in the shield clamping saddle compensates for deformation and settling that results from a connected shield.

Please find the entire product range in our full line catalog. For additional information, visit www.wago.com.

EPSITRON® – ADVANCED POWER SUPPLY SYSTEM

EPSITRON® POWER SUPPLIES



ECO Power

EPSITRON® ECO POWER

Single- and three-phase power supplies with a wide input voltage range and 24 V nominal output



COMPACT Power

EPSITRON® COMPACT POWER

Low-profile, single-phase power supplies with a wide input voltage range, as well as nominal output voltages of 5 V, 12 V, 18 V and 24 V



CLASSIC Power

EPSITRON® CLASSIC POWER

Single-phase power supplies with a wide input voltage range and 12 V, 24 V or 48 V nominal output



PRO Power

EPSITRON® PRO POWER

Single- and three-phase power supplies with a wide input voltage range, 12 V, 24 V or 48 V nominal output, PowerBoost, TopBoost and optional LineMonitor

EPSITRON® SYSTEM MODULES



ECBs

EPSITRON® ELECTRONIC CIRCUIT BREAKERS (ECBs)

Configurable, 2-, 4- or 8-channel ECBs feature integrated current and voltage monitoring.



UPS

EPSITRON® UNINTERRUPTIBLE POWER SUPPLIES (UPS)

UPS charger, controller and connected battery modules reliably endure longer power failures and feature integrated battery control technology.



Capacitive Buffer Modules

EPSITRON® CAPACITIVE BUFFER MODULES

Maintenance-free, capacitive buffer modules ensure seamless operation during short voltage fluctuations.



Redundancy Modules

EPSITRON® REDUNDANCY MODULES

Redundancy modules safeguard two power supplies that are parallel-connected, providing system redundancy or additional power.

EPSITRON® Power Supplies

ECO Power, Single- and Three-Phase

787 Series

	Input Nominal Voltage	Output Nominal Voltage	Output Current	Efficiency (230 VAC, Nominal Load)	Dimensions (W x H x L in mm)*	Item No.
	1 x 100 ... 240 VAC	24 VDC	1.25 A	88 % (typ.)	30 x 99 x 90	787-1702
			2.5 A	89 % (typ.)	40 x 99 x 90	787-1712
			5 A	89 % (typ.)	60 x 99 x 130	787-1722
			10 A	89 % (typ.)	70 x 99 x 165	787-1732
	1 x 110 ... 240 VAC	24 VDC	2.5 A	86 % (typ.)	50 x 92 x 136	787-712
			5 A	86 % (typ.)	75 x 92 x 136	787-722
			10 A	86 % (typ.)	110 x 92 x 136	787-732
			20 A	90 % (typ.)	115 x 144 x 136	787-734
			40 A	90 % (typ.)	170 x 153 x 136	787-736
	3 x (2 x) 400 ... 500 VAC	24 VDC	6.25 A	87 % (typ.)	50 x 92 x 136	787-738
			10 A	89 % (typ.)	65 x 130 x 136	787-740
			20 A	90 % (typ.)	110 x 153 x 136	787-742



Clear Indication

- Green LED indicates output voltage availability
- Red LED indicates an overcurrent or short circuit
- Easy commissioning and maintenance

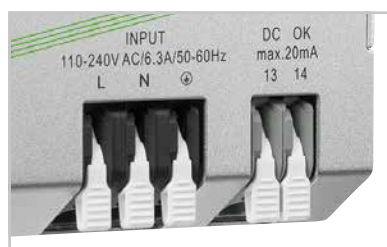

Fast Wiring

- Lever-actuated terminal strips (2706 or 2716 Series)
- Convenient, tool-free wiring
- Integrated test slot simplifies testing by eliminating conductor removal



Easy Grounding

- Integrated, third negative terminal on the output side**
- Direct connection to the reference ground, which is frequently used in machines and equipment

*Height (H) from upper-edge of DIN-35 rail

**only 787-734 ... -742

EPSITRON® Power Supplies

COMPACT Power, Single-Phase

787 Series

	Input Nominal Voltage	Output Nominal Voltage	Output Current	Efficiency	Dimensions (W x H x L in mm)*	Item No.
	1 x 100 ... 240 VAC	5 VDC	5.5 A at 5 VDC	75 % (typ.)	72 x 55 x 89	787-1020
	1 x 100 ... 240 VAC	12 VDC	2 A at 12 VDC / 0.75 A at 18 VDC	80 % (typ.)	54 x 55 x 89	787-1001
			4 A at 12 VDC	85 % (typ.)	72 x 55 x 89	787-1011
			6.5 A at 12 VDC	87 % (typ.)	90 x 55 x 89	787-1021
	1 x 100 ... 240 VAC	18 VDC	2.5 A at 18 VDC / 2.3 A at 24 VDC; 55 W (max.)	83 % (typ.) at 18 VDC / 2.5 A; 85 % (typ.) at 24 VDC / 2.3 A	72 x 55 x 89	787-1017
	1 x 100 ... 240 VAC	24 VDC	1.3 A at 24 VDC	82 % (typ.)	54 x 55 x 89	787-1002
			2.5 A at 24 VDC	88 % (typ.)	72 x 55 x 89	787-1012
			4 A at 24 VDC	88 % (typ.)	90 x 55 x 89	787-1022

7



Clear Indication

- Status indication via green LED
- Current operating status can be displayed quickly

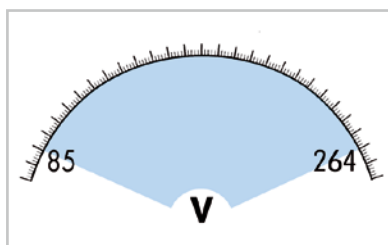

Supply Tolerance

- Single-phase, wide input voltage range
- High tolerance to voltage fluctuations within a power grid ensures a high level of operational reliability







Overhead Mounting

- Any type of mounting position is possible with reduced output power
- Units can even be mounted overhead (e.g., in ceiling-mounted distribution boxes)

EPSITRON® Power Supplies

CLASSIC Power, Single-Phase

787 Series

	Input Nominal Voltage	Output Nominal Voltage	Output Current	Efficiency	Dimensions (W x H x L in mm)*	Item No.
	1 x 100 ... 240 VAC	12 VDC	2 A	82 % (typ.)	22.5 x 107.5 x 90	787-1601
			4 A	86 % (typ.)	45 x 107.5 x 90	787-1611
			7 A	86 % (typ.)	52 x 119 x 90	787-1621
			15 A	90 % (typ.)	55 x 172 x 127	787-1631
  	1 x 100 ... 240 VAC	24 VDC	1 A	86 % (typ.)	22.5 x 107.5 x 90	787-1602
			2 A	89 % (typ.)	45 x 107.5 x 90	787-1606
			4 A	89 % (typ.)	52 x 119 x 90	787-1616
			5 A	89 % (typ.)	42 x 137.5 x 127	787-1622
			10 A	91 % (typ.)	55 x 172 x 127	787-1632

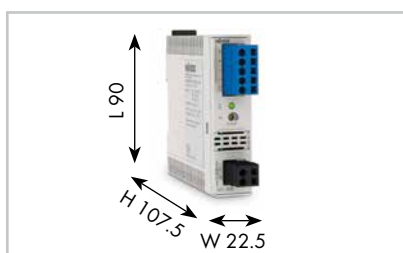

Slim Design

- Save valuable cabinet space

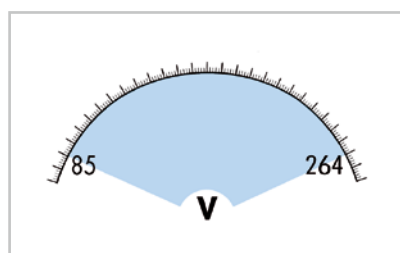

Universal Supply

- Wide input voltage range
- Can be operated worldwide
- High level of operational reliability



Integrated TopBoost

- Reliably trigger of the secondary-side fusing via miniature circuit breakers (≥ 120 W output power)

*Height (H) from upper-edge of DIN-35 rail

EPITRON® Power Supplies

CLASSIC Power, Single-, Two- and Three-Phase

787 Series

	Input Nominal Voltage	Output Nominal Voltage	Output Current	Efficiency	Dimensions (W x H x L in mm)*	Item No.
	1 x 100 ... 240 VAC	24 VDC	20 A	92 % (typ.)	95 x 170 x 127	787-1634
			3.8 A LPS / NEC Class 2	87 % (typ.)	52 x 119 x 90	787-1616/000-1000
	1 x 100 ... 240 VAC	48 VDC	2 A	86 % (typ.)	55 x 119 x 90	787-1623
			5 A	92 % (typ.)	55 x 172 x 127	787-1633
			10 A	93 % (typ.)	95 x 170 x 127	787-1635
	2 x 200 ... 500 VAC	24 VDC	5 A	89 % (typ.)	42 x 137 x 127	787-1628
	3 x 400 ... 500 VAC		10 A	90 % (typ.)	55 x 171 x 127	787-1640
			20 A	92 % (typ.)	80 x 180 x 127	787-1642
			40 A	92 % (typ.)	126 x 198 x 127	787-1644

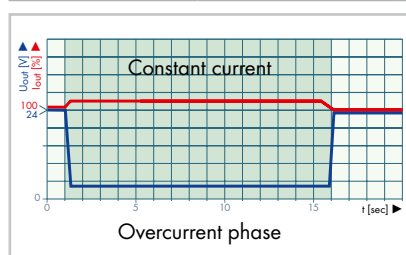

High Load-Carrying Capacity

- Constant current characteristic under overload conditions
- 110 % output current with lowered output voltage – even during a short circuit
- High capacitive loads can be reliably started



Clear and Easy to Connect

- CAGE CLAMP® connection technology – vibration-proof, fast, maintenance-free
- Colored and marked female connectors can be pre-assembled – 100 % protected against mismatching

EPSITRON® Power Supplies

PRO Power, Single- and Two-Phase

787 Series

	Input Nominal Voltage	Output Nominal Voltage	Output Current	Efficiency	PowerBoost	TopBoost	Dimensions (W x H x L in mm)*	Item No.
	1/2 x 100 ... 240 VAC	12 VDC	6 A at 12 VDC	83 % (typ.)	12 ADC (for 4 s), 9 ADC (for 8 s)	21 ADC (for 25 ms)	40 x 163 x 163	787-819
			10 A at 12 VDC	87.8 % (typ.)	20 ADC (for 4 s), 15 ADC (for 8 s)	60 ADC (for 25 ms), 40 ADC at $U_{IN} < 110$ VAC (for 25 ms)	57 x 163 x 163	787-821
			15 A at 12 VDC	87 % (typ.)	30 ADC (for 4 s), 22.5 ADC (for 8 s)	55 ADC (for 25 ms)	57 x 179 x 163	787-831
	1/2 x 100 ... 240 VAC	24 VDC	3 A at 24 VDC	87.8 % (typ.)	6 ADC (for 4 s), 4.5 ADC (for 8 s)	14 ADC (for 25 ms)	40 x 163 x 163	787-818
			5 A at 24 VDC	87.8 % (typ.)	10 ADC (for 4 s), 7.5 ADC (for 8 s)	21 ADC (for 25 ms)	57 x 163 x 163	787-822
			10 A at 24 VDC	90 % (typ.)	20 ADC (for 4 s), 15 ADC (for 8 s)	60 ADC (for 25 ms)	57 x 179 x 163	787-832
	1/2 x 110 ... 240 VAC		20 A at 24 VDC	91 % (typ.)	30 ADC (for 4 s), 25 ADC (for 8 s)	80 ADC (for 25 ms)	97 x 187 x 171	787-834
	1/2 x 110 ... 240 VAC	48 VDC	5 A at 48 VDC	91 % (typ.)	10 ADC (for 4 s), 7.5 ADC (for 8 s)	30 ADC (for 25 ms)	57 x 179 x 163	787-833
			10 A at 48 VDC	91 % (typ.)	17.5 ADC (for 4 s), 15 ADC (for 8 s)	60 ADC (for 25 ms)	97 x 187 x 171	787-835



TopBoost

- Multiplies the nominal current for up to 50 ms
- Fast and reliable triggering of the secondary-side fusing via miniature circuit breakers or melting fuses in the event of a short circuit or overload
- Fulfills EN 60204-1 grounding requirements in control circuits

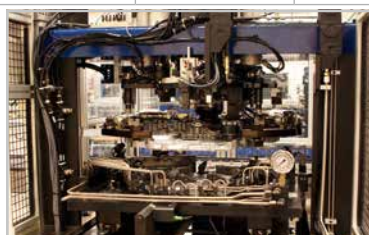

PowerBoost

- Provides 200 % of output power for four seconds
- Provides 150 % of output power for up to 16 seconds
- Advantageous during start-up or switching of capacitive loads (e.g., valve clusters, motors)
- Power reserve eliminates expensive oversizing

*Height (H) from upper-edge of DIN-35 rail

EPSITRON® Power Supplies

PRO Power, Two- and Three-Phase

787 Series

	Input Nominal Voltage	Output Nominal Voltage	Output Current	Efficiency	PowerBoost	TopBoost	Dimensions (W x H x L in mm)*	Item No.
	2/3 x 400 ... 500 VAC	24 VDC	10 A at 24 VDC	91.7 % (typ.)	20 ADC (for 4 s), 15 ADC (for 16 s)	70 ADC (for 50 ms)	57 x 179 x 163	787-840
			20 A at 24 VDC	92.9 % (typ.)	20 ADC (for 4 s), 15 ADC (for 16 s)	80 ADC (for 50 ms)	77 x 179 x 171	787-842
			40 A at 24 VDC	93.6 % (typ.)	60 ADC (for 4 s), 50 ADC (for 16 s)	100 ADC (for 50 ms)	128 x 205 x 171	787-844
	2/3 x 400 ... 500 VAC	48 VDC	10 A at 48 VDC	93 % (typ.)	15 ADC (for 4 s), 12.5 ADC (for 16 s)	55 ADC (for 50 ms)	77 x 179 x 171	787-845
			20 A at 48 VDC	94.4 % (typ.)	30 ADC (for 4 s), 25 ADC (for 16 s)	80 ADC (for 50 ms)	128 x 205 x 171	787-847
	2/3 x 400 ... 500 VAC	24 VDC	10 A at 24 VDC	91.7 % (typ.)	20 ADC (for 4 s), 15 ADC (for 16 s)	70 ADC (for 50 ms)	57 x 179 x 163	787-850*
			20 A at 24 VDC	92.9 % (typ.)	40 ADC (for 4 s), 30 ADC (for 16 s)	80 ADC (for 50 ms)	77 x 179 x 171	787-852*
			40 A at 24 VDC	93.6 % (typ.)	60 ADC (for 4 s), 50 ADC (for 16 s)	100 ADC (for 50 ms)	128 x 205 x 171	787-854*

*Device features LineMonitor capability for parameter setting and monitoring, as well as active signal outputs and serial interface.

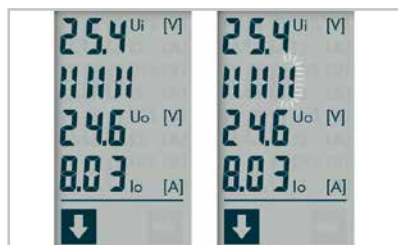

Innovative Communication

- LineMonitor with display and function keys
- Variable monitoring, e.g., current, voltage, phase position, operating hours and more
- Output voltage and overload behavior can be parameterized
- Integrated fault memory

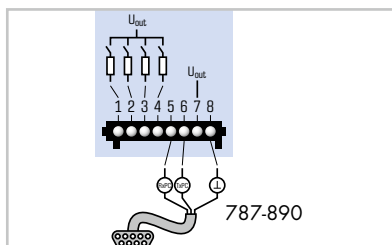

Active Signal Contacts

- Four active signal outputs for watchdog functions
- Each unit features a separate collective message for warning/fault
- Features two individually configurable signal outputs
- Free 759-850 Configuration Software can be downloaded at: www.wago.com





RS-232 Serial Interface

- Front-side integrated interface communicates with a PC or PLC
- Free 759-850 Configuration Software and 759-851 Visualization Software can be downloaded at www.wago.com
- Free function blocks are available for various PLC systems
- Optional serial 787-890 Communication Cable is available

EPSITRON® Power Supplies

DC/DC Converters

787 Series

	Input Nominal Voltage	Output Nominal Voltage	Output Current	Efficiency	Dimensions (W x H x L in mm)*	Item No.
	24 VDC	5 VDC	0.5 A	78 % (typ.)	6 x 96 x 94	787-2801
	24 VDC	10 VDC	0.5 A	86.5 % (typ.)	6 x 96 x 94	787-2802
	48 VDC	24 VDC	0.25 A	87 % (typ.)	6 x 96 x 94	787-2803
	24 VDC	12 VDC	0.5 A	88 % (typ.)	6 x 96 x 94	787-2805
	24 VDC	5/10/12 VDC	0.5 A	78 % (typ.)	6 x 96 x 94	787-2810
	72 VDC	24 VDC	2.5 A at 24 VDC, 1.6 A (max.) in any mounting position	84 % (typ.)	72 x 55 x 89	787-1014/072-000
	110 VDC	24 VDC	2.0 A at 24 VDC	85 % (typ.)	72 x 55 x 89	787-1014

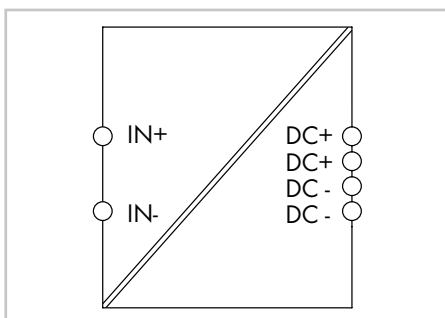

Electrical isolation up to 4.2 kV

*Height (H) from upper-edge of DIN-35 rail

EPSITRON® Power Supplies

Electronic Circuit Breakers (ECBs)



787 Series

	Description	Input Nominal Voltage	Nominal Current (adjustable channel-by-channel via rotary switch)	LED Indication	Dimensions (W x H x L in mm)*	Item No.
	ECB	24 VDC	2 x 2, 3, 4, 6, 8, 10 A	2 x LED (green/red/orange), 2 x signal output	45 x 115.5 x 90	787-1662
	ECB with Active Current Limitation		2 x 0.5, 1, 2, 3, 4, 6 A	2 x LED (green/red/orange), 2 x signal output		787-1662/006-1000
	ECB		2 x 1, 2, 3, 4, 5, 6 A	2 x LED (green/red/orange), 2 x signal output		787-1662/106-000
	ECB with Active Current Limitation		2 x 2, 4, 6, 8, 10, 12 A	2 x LED (green/red/orange), 2 x signal output		787-1662/212-1000
	ECB	24 VDC	4 x 2, 3, 4, 6, 8, 10 A	4 x LED (green/red/orange), 2 x signal output	45 x 115.5 x 90	787-1664
	ECB (Default setting: 2 ADC, switched off, modified group signal)		4 x 2, 3, 4, 6, 8, 10 A	4 x LED (green/red/orange), 2 x signal output		787-1664/000-004
	ECB with Active Current Limitation		4 x 0.5, 1, 2, 3, 4, 6 A	4 x LED (green/red/orange), 2 x signal output		787-1664/006-1000
	ECB		4 x 1, 2, 3, 4, 5, 6 A	4 x LED (green/red/orange), 2 x signal output		787-1664/106-000
	ECB with Active Current Limitation		4 x 2, 4, 6, 8, 10, 12 A	4 x LED (green/red/orange), 2 x signal output		787-1664/212-1000

EPSITRON® Power Supplies

Electronic Circuit Breakers (ECBs)

787 Series

	Description	Input Nominal Voltage	Nominal Current (adjustable channel-by-channel via rotary switch)	LED Indication	Dimensions (W x H x L in mm)*	Item No.
	ECB	24 VDC	8 x 2, 3, 4, 6, 8, 10 A	8 x LED (green/red/orange)	42 x 142.5 x 127	787-1668
	ECB (Default setting: 2 ADC, switched off, modified group signal)		8 x 2, 3, 4, 6, 8, 10 A	8 x LED (green/red/orange)	42 x 142.5 x 127	787-1668/000-004
	ECB with Active Current Limitation		8 x 0.5, 1, 2, 3, 4, 6 A	8 x LED (green/red/orange)	42 x 142.5 x 127	787-1668/006-1000
	ECB		8 x 1, 2, 3, 4, 5, 6 A	8 x LED (green/red/orange)	42 x 142.5 x 127	787-1668/106-0000
	ECB	24 VDC	4 x 1 ... 6 A (adjustable for each channel in 1 A steps)	LCD, 4 x signal output	40 x 163 x 171	787-860
	ECB with Active Current Limitation		4 x 1 ... 8 A (adjustable for each channel in 1 A steps)	LCD, 4 x signal output	40 x 163 x 171	787-861
	ECB		4 x 1 ... 10 A (adjustable for each channel in 1 A steps)	LCD, 4 x signal output	40 x 163 x 171	787-862



Intuitive Communication





- Each output channel has backlit buttons for switching on/off, as well as acknowledgement
- Nominal current can be individually adjusted for each channel
- Integrated, multi-color LEDs indicate the operating status of each channel
- The setting is always visible – even when no voltage is applied
- Transparent cover can be sealed and marked

*Height (H) from upper-edge of DIN-35 rail

EP SITRON® Power Supplies

Electronic Circuit Breakers (ECBs)

787 Series

	Description	Input Nominal Voltage	Nominal Current	LED Indication	Dimensions (W x H x L in mm)*	Item No.
	ECB	12 VDC	2 x 2, 3, 4, 6, 8, 10 A (adjustable channel-by-channel via rotary switch)	2 x LED (green/red/orange), 2 x signal output	45 x 115.5 x 90	787-1662/000-100
	ECB		4 x 2, 3, 4, 6, 8, 10 A (adjustable channel-by-channel via rotary switch)	4 x LED (green/red/orange), 2 x signal output	45 x 115.5 x 90	787-1664/000-100
	ECB	48 VDC	2 x 2, 3, 4, 6, 8, 10 A (adjustable channel-by-channel via rotary switch)	2 x LED (green/red/orange), 2 x signal output	45 x 115.5 x 90	787-1662/000-200
	ECB		4 x 2, 3, 4, 6, 8, 10 A (adjustable channel-by-channel via rotary switch)	4 x LED (green/red/orange), 2 x signal output	45 x 115.5 x 90	787-1664/000-200
	ECB		8 x 2, 3, 4, 6, 8, 10 A (adjustable channel-by-channel via rotary switch)	8 x LED (green/red/orange), 2 x signal output	42 x 142.5 x 127	787-1668/000-200

7



Communication 1.0

- Remote digital input S1 resets all tripped channels
- Digital output S3 transmits a simple group message indicating if one of the channels was triggered by an overcurrent
- Optional isolated signal contact** as a group signal (instead of S2 and S3 digital outputs)

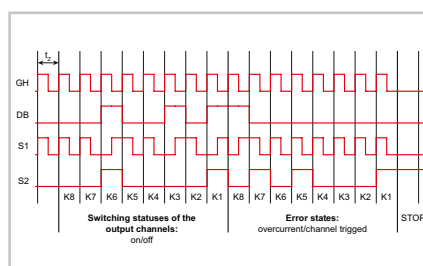

Communication 2.0

- Remote digital input (S1) switches on and off certain channels via pulse sequence
- Digital output (S2) transmits the current status (on/off/tripped/overcurrent) of each individual channel
- Optional transmission of input voltage and output/nominal current value for each channel

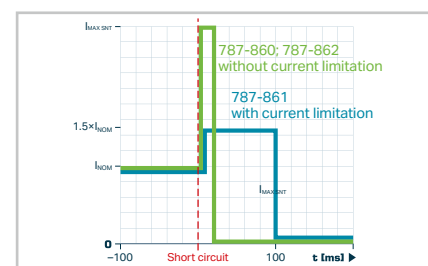

Trip Characteristics

- Reliable and precise disconnection in case of an overcurrent or short circuit
- Nominal currents can be set separately for each channel
- Tripping time can be optionally configured in defined increments
- Optional, active short circuit current limitation to 1.5 times the nominal current prevents a voltage drop in other current paths

**e.g. 787-166x/000-054 and 787-166x/000-250

EPSITRON® Power Supplies

Uninterruptible Power Supplies (UPS)

787 Series

	Description	Input Nominal Voltage	Output Current	Buffer Time	Dimensions (W x H x L in mm)*	Item No.
	Power Supply, 24 VDC, 1-phase, with integrated UPS charger and controller	100 ... 240 VAC	5 A	0.5 s ... 20 min, IPC mode or constant (adjustable)	60 x 135.5 x 127	787-1675
	UPS Chargers and Controllers	24 VDC	10 A	10 s ... 600 s, IPC mode or constant (adjustable)	40 x 163 x 163	787-870
			20 A	10 s ... 600 s, IPC mode or constant (adjustable)	57 x 163 x 171	787-875
	Lead-Acid AGM Battery Modules	24 VDC	7.5 A (max.)	1.2 Ah	55 x 136.5 x 153	787-876
			20 A (max.)	3.2 Ah	76.2 x 175.5 x 168	787-871
			40 A (max.)	7 Ah	86 x 217.5 x 239	787-872
			40 A (max.)	12 Ah	120.5 x 217.5 x 239	787-873

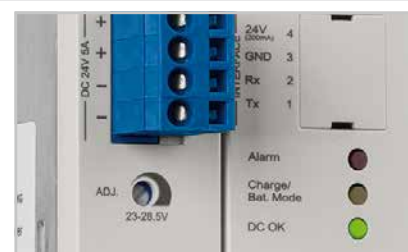
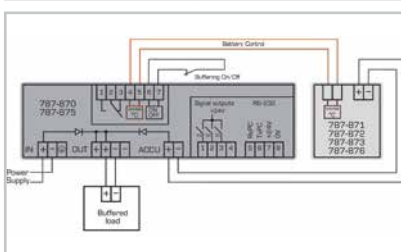

EPSITRON® Battery Control Technology

- Continuous data exchange between intelligent battery modules (787-87x) and UPS charger/controller prevents the gas generation in the battery
- Automatic detection of 787-87x Battery Modules
- Maximized battery life via temperature-controlled battery management
- Reliable, early warning of decreasing battery life
- Displays current charging status on site (787-870 and 787-875)

Diagnostics, Monitoring, Configuration

- LEDs display operating status, warnings and errors
- Signal outputs can be processed as a digital signal in a PLC
- Potential-free signal contacts
- Parameter setting via on-unit buttons or rotary switch
- Visualization or configuration via RS-232 serial interface
- Communication cables 787-890/-892 for 787-1675
- UPS software 759-870

*Height (H) from upper-edge of DIN-35 rail

EP SITRON® Power Supplies

Capacitive Buffer and Redundancy Modules

787 Series

	Description	Input Nominal Voltage	Output Nominal Voltage	Output Current	Buffer Time	Efficiency	Dimensions (W x H x L in mm)*	Item No.
	Capacitive Buffer Modules	24 VDC		10 A	0.06 ... 7.2 s (depends on load current and switching threshold)	-	57 x 179 x 163	787-880
				20 A	0.17 ... 16.5 s (depends on load current and switching threshold)	-	57 x 179 x 181	787-881
	Diode Redundancy Module	2 x 24 VDC	24 VDC	20 A, 40 A (max.)	-	97 % (typ.)	40 x 163 x 181	787-885
	Diode Redundancy Module	2 x 48 VDC	48 VDC	20 A, 40 A (max.)	-	96 % (typ.)	40 x 163 x 181	787-886
	Diode Redundancy Module	2 x 24 VDC (9 ... 54 VDC)	24 VDC (1 x 9 ... 54 VDC)	12.5 A (max.) as redundancy module, 25 A (max.) in parallel operation	-	96 % (typ.)	50 x 92 x 130	787-783
	Diode Redundancy Module	2 x 24 VDC (9 ... 54 VDC)	24 VDC (1 x 9 ... 54 VDC)	40 A (max.) as redundancy module, 76 A (max.) in parallel operation	-	97 % (typ.)	83 x 153 x 130	787-785
	MOSFET Redundancy Module	2 x 24 VDC (10 ... 36 VDC)	24 VDC (1 x 10 ... 36 VDC)	20 A, 40 A (max.)	-	99.5 % (typ.)	42 x 139.5 x 127	787-1685

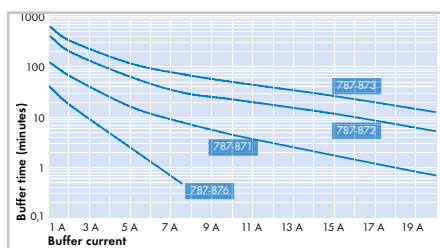

Buffer Time vs. Load Current

Different buffer times/currents can be achieved depending on the battery module selected. The example below shows a 7 A load current provided for approximately 30 seconds by a 787-870 UPS Charger/Controller (10 A) and 787-876 Battery Module.

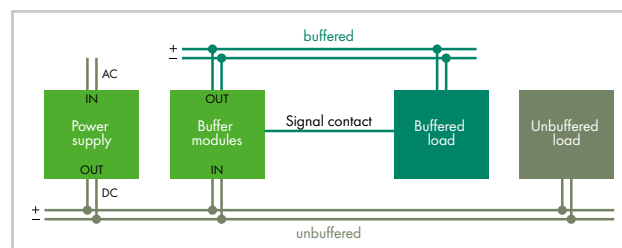











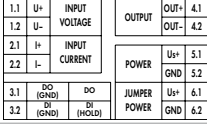

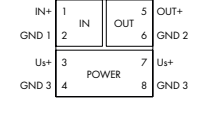

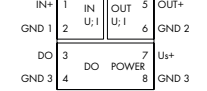

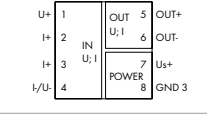

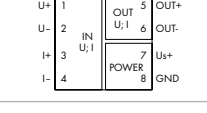

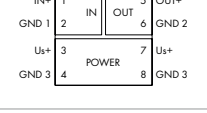

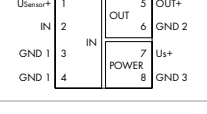
Decoupled Output

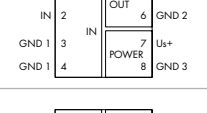
- Integrated diode
- Buffered and unbuffered loads can be decoupled
- Multiple buffer modules can be parallel-connected to increase buffer time or load current

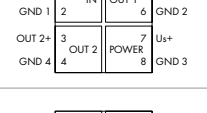
JUMPFLEX® Signal Conditioning System

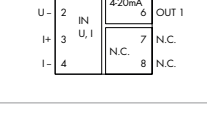
Isolation Amplifiers

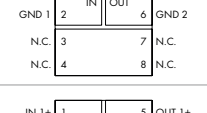
857/2857 Series

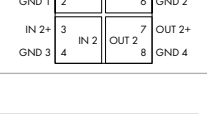
	Description	Input Signal			Item No.
		Current	Voltage	Bipolar Signals (I/U)	
	Universal Isolation Amplifier 	0 ... 1 mA 0 ... 10 mA 2 ... 10 mA 0 ... 20 mA 4 ... 20 mA 0 ... 100 mA	0 ... 5 V 1 ... 5 V 0 ... 10 V 2 ... 10 V 0 ... 220 V	±1 mA, ±10 mA, ±20 mA, ±100 mA ±1 V, ±10 V, ±30 V, ±100 V, ±200 V	857-401
	Isolation Amplifier, configurable, with zero/span adjustment 	0 ... 10 mA 2 ... 10 mA 0 ... 20 mA 4 ... 20 mA	0 ... 5 V 1 ... 5 V 0 ... 10 V 2 ... 10 V		857-400
	Isolation Amplifier, configurable, with digital output (DO) 	0 ... 10 mA 2 ... 10 mA 0 ... 20 mA 4 ... 20 mA	0 ... 5 V 1 ... 5 V 0 ... 10 V 2 ... 10 V	±20 mA ±10 V	857-401
	Universal Isolation Amplifier 	0 ... 0.3 mA to 0 ... 100 mA	0 ... 60 mV to 0 ... 200 V	±0.3 mA to ±100 mA ±60 mV to ±200 mV	857-402
	Bipolar Isolation Amplifier 	0 ... 10 mA 2 ... 10 mA 0 ... 20 mA 4 ... 20 mA	0 ... 5 V 1 ... 5 V 0 ... 10 V 2 ... 10 V	±10 mA ±20 mA ±5 V ±10 V	857-409
	Isolation Amplifiers, fixed for current or voltage signals 	0 (4) ... 20 mA	0 (2) ... 10 V 0 ... 10 V 0 ... 10 V		857-411 857-412 857-413 857-414 857-415 857-416
	Repeater Power Supply, configurable, with current and voltage output 	0 ... 20 mA 4 ... 20 mA			857-420
	HART Repeater Power Supply 	4 ... 20 mA			857-421
	Signal Splitter, with two configurable current outputs 	0 ... 20 mA 4 ... 20 mA	0 ... 5 V 1 ... 5 V 0 ... 10 V 2 ... 10 V		857-423
	Loop-Powered Isolation Amplifier 	0 ... 5 mA 0 ... 10 mA 2 ... 10 mA 0 ... 20 mA 4 ... 20 mA	0 ... 1 V 0 ... 5 V 1 ... 5 V 0 ... 10 V 2 ... 10 V	±5 mA ±10 mA ±20 mA ±1 V, ±5 V ±10 V ±20 V	857-450
	Passive Isolator, 1-channel 	0(4) ... 20 mA			857-451
	Passive Isolator, 2-channel 	2 x 0(4) ... 20 mA			857-452

Conductor termination

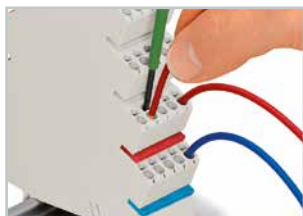

Commoning



Ambient operating temperature range:

857 Series: -25 °C ... +70 °C

2857 Series: -40 °C ... +70 °C

Conductor range:

857 Series - solid: 0.08 ... 2.5 mm² / 28 ... 14 AWG

fine-stranded: 0.34 ... 2.5 mm² / 22 ... 14 AWG

2857 Series - solid/fine-stranded: 0.2 ... 2.5 mm² / 24 ... 12 AWG

For jumpers, see page 204.

	Isolation Voltage	Output Signal			Nominal Supply Voltage U_s	Configuration	Specialty Functions
		Current	Voltage	Bipolar Signals (I/U)			
	4 kV	0 ... 10 mA 2 ... 10 mA 0 ... 20 mA 4 ... 20 mA	0 ... 5 V 1 ... 5 V 0 ... 10 V 2 ... 10 V	± 10 mA ± 20 mA ± 5 V ± 10 V	24 VDC	DIP switches, interface configuration software/app/display	Digital output (DO), clipping
	2.5 kV	0 ... 20 mA 4 ... 20 mA	0 ... 5 V 1 ... 5 V 0 ... 10 V 2 ... 10 V		24 VDC	DIP switches	Zero/span adjustment
	2.5 kV	0 ... 10 mA 2 ... 10 mA 0 ... 20 mA 4 ... 20 mA	0 ... 5 V 1 ... 5 V 0 ... 10 V 2 ... 10 V		24 VDC	DIP switches, interface configuration software/app	Digital output (DO), clipping
	2.5 kV	0 ... 20 mA 4 ... 20 mA	0 ... 5 V 1 ... 5 V 0 ... 10 V 2 ... 10 V	± 10 mA ± 20 mA ± 5 V ± 10 V	24 VDC	DIP switches, push/slide switch	Clipping, zero/span adjustment
	2.5 kV	0 ... 10 mA 2 ... 10 mA 0 ... 20 mA 4 ... 20 mA	0 ... 5 V 1 ... 5 V 0 ... 10 V 2 ... 10 V	± 10 mA ± 20 mA ± 5 V ± 10 V	24 VDC	DIP switches	Zero/span adjustment
	2.5 kV	0 (4) ... 20 mA	0 (4) ... 20 mA 0 (2) ... 10 V		24 VDC		
		0 ... 20 mA					
		4 ... 20 mA					
			0 ... 10 V 0 ... 10 V				
	2.5 kV	0 ... 20 mA 4 ... 20 mA	0 ... 5 V 1 ... 5 V 0 ... 10 V 2 ... 10 V		24 VDC	DIP switches	
	2.5 kV	4 ... 20 mA			24 VDC		
	2.5 kV	2 x 0(4) ... 20 mA			24 VDC	DIP switches	
	2.5 kV	4 ... 20 mA			Power via output	DIP switches	Zero/span adjustment
	2.5 kV	0(4) ... 20 mA			Power via input		
	2.5 kV	2 x 0(4) ... 20 mA			Power via input		

Marking



WMB marking system



Micro-WSB marking system





Marking strips





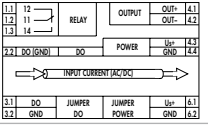

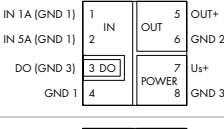
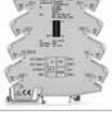
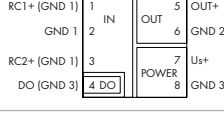

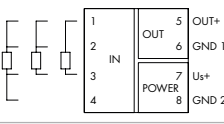

JUMPFLEX® Signal Conditioning System

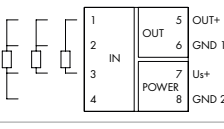
Current and Temperature Signal Conditioners

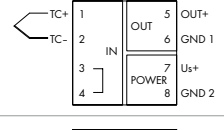
857/2857 Series

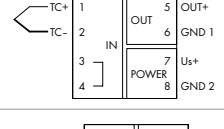
	Description	Input Signal		Item No.
		Current		
	Through-Hole Current Signal Conditioner		100 A AC/DC	2857-550
	Current Signal Conditioner, with digital output (DO)		1 A AC/DC 5 A AC/DC	857-550
	Current Signal Conditioner for Rogowski Coils, with digital output (DO)		Rogowski coils 500 AAC 2,000 AAC	857-552

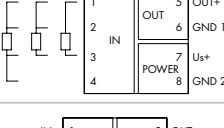
Temperature Signal Conditioners

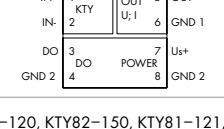
	Description	Input Signal	Sensor Connection	Isolation Voltage	Item No.
	Temperature Signal Conditioner for Pt sensors and resistance sensors		Pt sensors: Pt100, Pt200, Pt500, Pt1000 Resistance sensors: 0 ... 1 kΩ; 0 ... 4.5 kΩ	2.5 kV	857-800
	Temperature Signal Conditioner for Pt sensors and resistance sensors		Pt sensors: Pt100, Pt200, Pt500, Pt1000 Resistance sensors: 0 ... 1 kΩ; 0 ... 4.5 kΩ	2.5 kV	857-801
	Temperature Signal Conditioner for thermocouples		Thermocouples: Type J, K	2.5 kV	857-810
	Temperature Signal Conditioner for thermocouples		Thermocouples: Type J, K, E, R, N, S, T, B, S	2.5 kV	857-811
	Temperature Signal Conditioner for Ni sensors		Ni sensors: Ni100, Ni120, Ni200, Ni500, Ni1000	2.5 kV	857-818
	KTY Signal Conditioner with digital output (DO)		KTY sensors*	2.5 kV	857-820

*KTY81-110, KTY81-120, KTY81-150, KTY82-110, KTY82-120, KTY82-150, KTY81-121, KTY82-121, KTY81-122, KTY82-122, KTY81-210, KTY81-220, KTY82-210, KTY82-220, KTY81-221, KTY82-221, KTY81-222, KTY82-222, KTY81-250, KTY82-250, KTY83-110, KTY83-120, KTY83-150, KTY83-121, KTY83-122, KTY83-151, KTY84-130, KTY84-150, KTY84-151, KTY16, KTY19, ST13, ST20

Configuration Options:



DIP switches



Bluetooth® Adapter 750-921

Push/slide switch
(857 Series only)

	Isolation Voltage	Output Signal			Nominal Supply Voltage U_s	Configuration	Specialty Functions
		Current	Voltage	Bipolar Signals (I/U)			
	4 kV	0 ... 10 mA 2 ... 10 mA 0 ... 20 mA 4 ... 20 mA	0 ... 5 V 1 ... 5 V 0 ... 10 V 2 ... 10 V	± 10 mA ± 20 mA ± 5 V ± 10 V	24 VDC	DIP switches, interface configuration software/app/display	Digital output (DO), clipping, relay (1 changeover contact)
	2.5 kV	0 ... 10 mA 2 ... 10 mA 0 ... 20 mA 4 ... 20 mA	0 ... 5 V 1 ... 5 V 0 ... 10 V 2 ... 10 V		24 VDC	DIP switches, interface configuration software/app	Digital output (DO), clipping
	2.5 kV	0 ... 10 mA 2 ... 10 mA 0 ... 20 mA 4 ... 20 mA	0 ... 5 V 1 ... 5 V 0 ... 10 V 2 ... 10 V		24 VDC	DIP switches, interface configuration software/app	Digital output (DO), clipping

	Sensor Temperature Range	Output Signal			Nominal Supply Voltage U_s	Configuration	Specialty Functions
		Current	Voltage				
	-200 °C ... +850 °C	0 ... 10 mA 2 ... 10 mA 0 ... 20 mA 4 ... 20 mA	0 ... 5 V 1 ... 5 V 0 ... 10 V 2 ... 10 V		24 VDC	DIP switches	Clipping
	-200 °C ... +850 °C	0 ... 10 mA 2 ... 10 mA 0 ... 20 mA 4 ... 20 mA	0 ... 5 V 1 ... 5 V 0 ... 10 V 2 ... 10 V		24 VDC	DIP switches, interface configuration software/app	Clipping
	Type J: -150 °C ... +1,200 °C Type K: -150 °C ... +1,350 °C	0 ... 10 mA 2 ... 10 mA 0 ... 20 mA 4 ... 20 mA	0 ... 5 V 1 ... 5 V 0 ... 10 V 2 ... 10 V		24 VDC	DIP switches	Clipping
	Type J: -150 °C ... +1,200 °C Type K: -150 °C ... +1,350 °C	0 ... 10 mA 2 ... 10 mA 0 ... 20 mA 4 ... 20 mA	0 ... 5 V 1 ... 5 V 0 ... 10 V 2 ... 10 V		24 VDC	DIP switches, interface configuration software/app	Clipping
		0 ... 10 mA 2 ... 10 mA 0 ... 20 mA 4 ... 20 mA	0 ... 5 V 1 ... 5 V 0 ... 10 V 2 ... 10 V		24 VDC	DIP switches	Clipping
		0 ... 10 mA 2 ... 10 mA 0 ... 20 mA 4 ... 20 mA	0 ... 5 V 1 ... 5 V 0 ... 10 V 2 ... 10 V		24 VDC	DIP switches	Digital output (DO), clipping

Ambient operating temperature range:

857 Series: -25 °C ... +70 °C

2857 Series: -40 °C ... +70 °C



2857-900 Configuration Display
(2857 Series only)



JUMPFLEX®-ToGo Smartphone App







Interface Configuration Software with
WAGO USB Communication cable
750-923



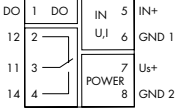

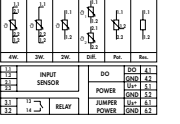
JUMPFLEX® Signal Conditioning System

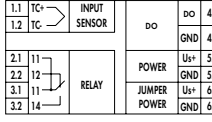
Threshold Value Switches

857/2857 Series

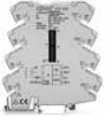
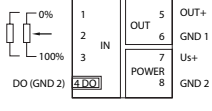

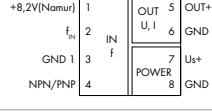

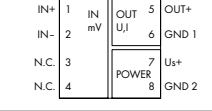

	Description		Input Signal			Item No.
			Current	Voltage	Bipolar Signals (I/U)	
	Threshold Value Switch with digital output (DO), analog input and changeover relay output		0 ... 10 mA 2 ... 10 mA 0 ... 20 mA 4 ... 20 mA	0 ... 5 V, 1 ... 5 V, 0 ... 10 V, 2 ... 10 V 0 ... 15 V, 0 ... 30 V	±10 mA ±20 mA ±5 V ±10 V	857-531
	RTD Threshold Value Switch			0 ... 100 kΩ, Pt100, Pt200, Pt500, Pt1000, Pt5000, Pt10,000, Pt10 ... 20,000		2857-533
	Thermocouple Threshold Value Switch			Type J, K, E, N, R, S, T, B, C		2857-534

Signal Conditioners with Specialty Functions

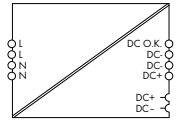
	Description		Input Signal	Item No.
	Potentiometer Signal Conditioner with digital output (DO)		Potentiometers: 0 ... 100 kΩ Resistors: 10 ... 100 kΩ	857-809
	Frequency Signal Conditioner		Frequency signals, NAMUR, NPN or PNP sensors: 0.1 Hz ... 120 kHz	857-500
	Millivolt Signal Conditioner with ranges -100 mV ... +100 mV and 0 mV ... 1000 mV		0 mV ... 200 mV to 0 mV ... 1000 mV, ±100 mV	857-819

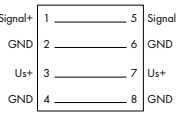
Ambient operating temperature for all devices: -25 °C ... +70 °C

Accessories

	Description		Item No.
	Switched-Mode Power Supply in 2857 Series housing		787-2852
	Supply and Through Module		857-979
	Configuration Display	Easy mounting on 2857 Series modules	2857-900
	Push-In Type Jumper Bars, insulated, 18 A, light gray	○ 2-way ○ 3-way ⋮ ○ 10-way ● yellow ● red ● blue	859-402 859-403 ⋮ 859-410 .../000-029 .../000-005 .../000-006
	Comb-Style Jumper Bar for clamping unit	○ 2-way	281-482





Application example for 281-482 Comb-Style Jumper Bar

	Isolation Voltage	Output Signal		Nominal Supply Voltage U_s	Configuration	Specialty Functions
		Relay (1 Changeover Contact)	Relay (1 Make Contact)			
	2.5 kV	250 VAC 6 A		24 VDC	DIP switches, push/slide switch, interface configuration software/app	Digital output (DO)
	4 kV		250 VAC 6 A	24 VDC	DIP switches, interface configuration software/app/display	Digital output (DO)
	4 kV	250 VAC 6 A		24 VDC	DIP switches, interface configuration software/app/display	Digital output (DO)

	Isolation Voltage	Output Signal		Nominal Supply Voltage U_s	Configuration	
		Current	Voltage			
	2.5 kV	0 ... 10 mA 2 ... 10 mA 0 ... 20 mA 4 ... 20 mA	0 ... 5 V 1 ... 5 V 0 ... 10 V 2 ... 10 V	24 VDC	DIP switches, push/slide switch, interface configuration software/app	Clipping
	2.5 kV	0 ... 10 mA 2 ... 10 mA 0 ... 20 mA 4 ... 20 mA	0 ... 5 V 1 ... 5 V 0 ... 10 V 2 ... 10 V	24 VDC	DIP switches, interface configuration software/app	Clipping
	2.5 kV	0 ... 10 mA 2 ... 10 mA 0 ... 20 mA 4 ... 20 mA	0 ... 5 V 1 ... 5 V 0 ... 10 V 2 ... 10 V	24 VDC	DIP switches, interface configuration software/app	Clipping

Accessories

	Description		Item No.
	Interface Adapter	with 16-pole ribbon cable connector per DIN 41651, for signal conditioners	857-980
	Ribbon Cable*	16-pole, free end, 2 m long	706-100/1602-200
	Bluetooth® Adapter		750-921
	WAGO USB Communication Cable , connection between PC and coupler/controller (suitable for JUMPFLEX®)	2.5 m	750-923
		5 m	750-923/000-001

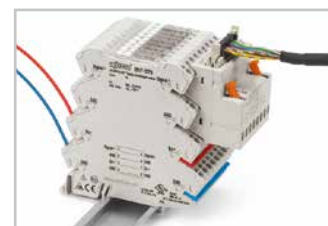

Application example for 857-980 Interface Adapter and 706-100/1602-200 Ribbon Cable

*Additional cables upon request

Relay Modules

- System Overview and Installation -

857 Series Relay Sockets

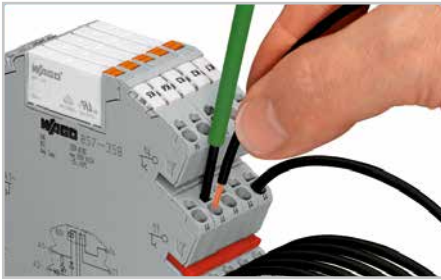

Inserting a conductor via operating tool.

859 Series Rail-Mounted Terminal Blocks with Relay and Optocoupler

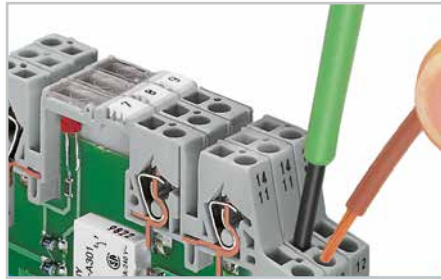

Inserting a conductor via operating tool.

788 Series Sockets with a Miniature Switching Relay

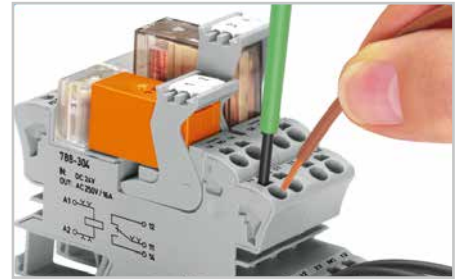

Inserting a conductor via operating tool.



Easy commoning via adjacent jumpers.



Easy commoning via adjacent jumpers.

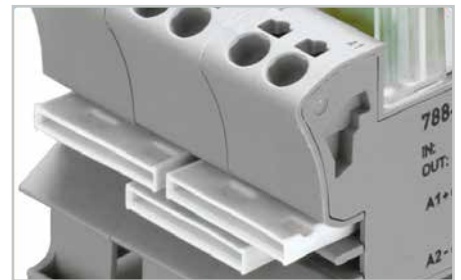

Easy commoning via adjacent jumpers.



Marking via WMB Multi Marking System.



Marking via Miniature WSB Quick Marking System.



Marking via WMB Multi Marking System and group marker carriers.



Removing a relay via ejector.



LED status indication

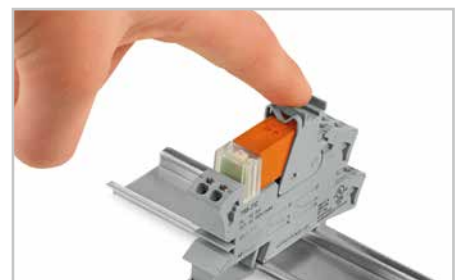

Relay socket with ejector

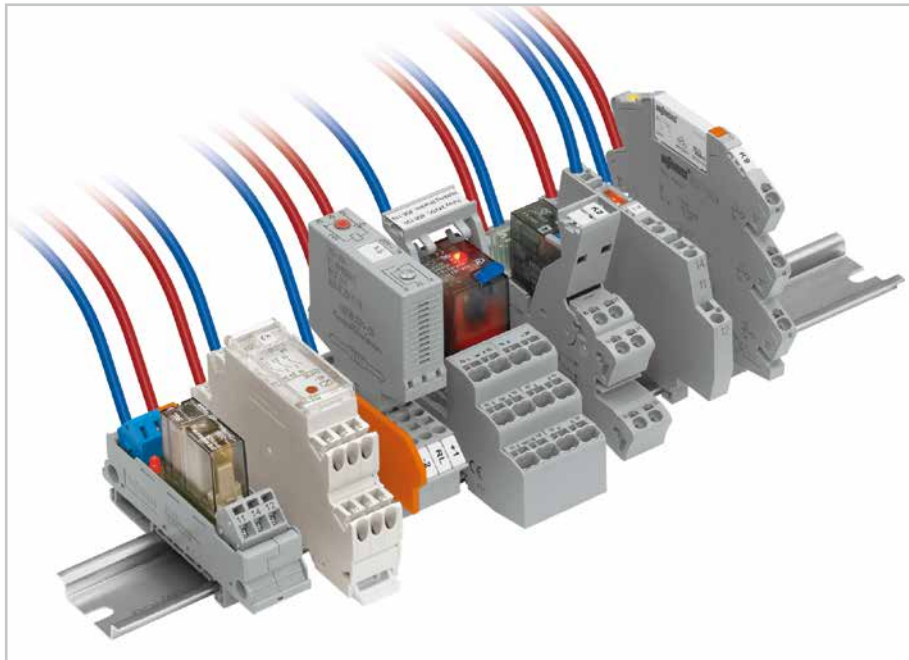

288 Series DIN-Rail-Mount Relay Modules

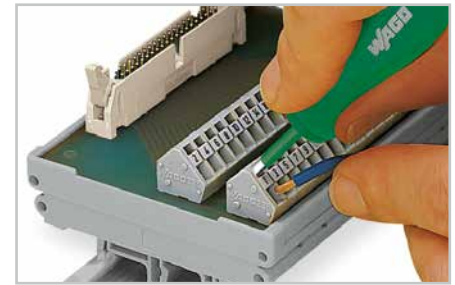

"Front-entry" conductor termination

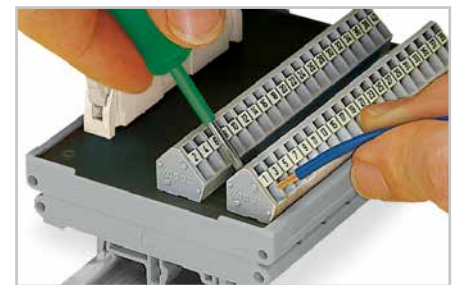

"Side-entry" conductor termination

858 Series Sockets with an Industrial Relay

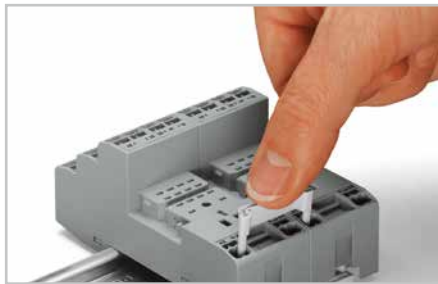

Commoning by simply pushing an adjacent jumper into conductor entry holes.

789 Series Relay Modules in a DIN-Rail-Mount Enclosure



Inserting a conductor via operating tool.

286/786 Series Pluggable Function Modules for Carrier Terminal Blocks

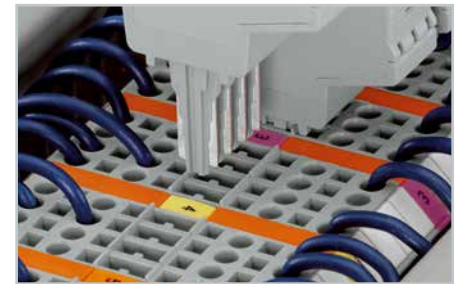

Coding ensures correct polarity.



Removing jumper via operating tool.



Easy commoning via adjacent jumpers.

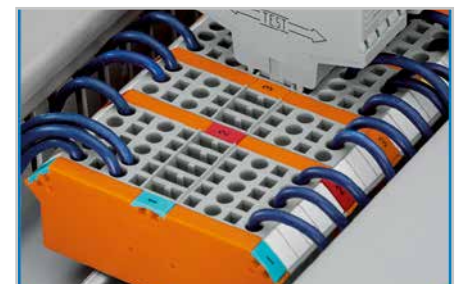

Marking via WMB Multi Marking System.



Inserting/ejecting a relay.









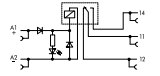
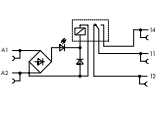

Function testing via touch-proof test slots.

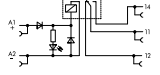
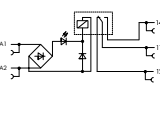
Relay Modules

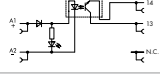
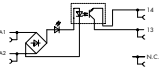
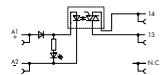
Miniature Switching and Solid-State Relay Sockets

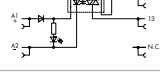
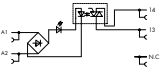
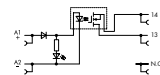
857 Series

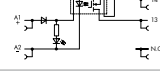
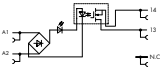
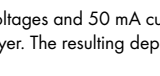
	Description	Input Nominal Voltage U_N	Max. Switching Voltage	Limiting Continuous Current	Item No.
	Relay modules with 1 changeover contact	 12 VDC 24 VDC 48 VDC 60 VDC	250 VAC	6 A	857-303 857-304 857-305 857-306
		 AC/DC 24 V 115 V 230 V 24 ... 230 V	250 VAC	6 A	857-354 857-357 857-358 857-359
	Relay modules with 1 changeover contact and gold contacts	 24 VDC	250 VAC*	6 A*	857-314
		 AC/DC 24 V 115 V 230 V 24 ... 230 V	250 VAC*	6 A*	857-364 857-367 857-368 857-369
	Solid-state relay modules	 24 VDC	0 ... 48 VDC	100 mA	857-704
		 115 VAC/DC	0 ... 48 VDC	100 mA	857-707
		 230 VAC/DC	0 ... 48 VDC	100 mA	857-708
	Solid-state relay modules	 24 VDC	24 ... 240 VAC	1 A	857-714
		 115 VAC/DC	24 ... 240 VAC	1 A	857-717
		 230 VAC/DC	24 ... 240 VAC	1 A	857-718
	Solid-state relay modules	 24 VDC	0 ... 24 VDC	2 A	857-724
		 115 VAC/DC	0 ... 24 VDC	2 A	857-727
		 230 VAC/DC	0 ... 24 VDC	2 A	857-728

*To prevent damaging the gold layer, 30 VDC switching voltages and 50 mA currents shall not be exceeded.
Higher switching power eventually evaporates the gold layer. The resulting deposits in the housing may reduce the service life.

Conductor range (857 Series): 0.34 ... 2.5 mm² / 22 ... 14 AWG
Connection technology (857 Series): Push-in CAGE CLAMP® (see page 14)







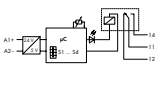

Marking using WMB Multi markers

For jumpers, see page 213.

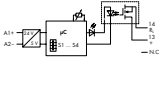

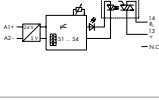

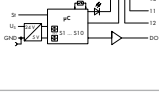
Relay Modules

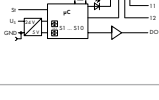
Multifunction Timer Relay Modules

857 Series

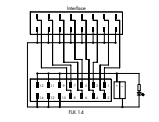
	Description		Input Nominal Voltage U_N	Output Nominal Voltage	Limiting Continuous Current	Item No.
	Timer relay module with 1 changeover contact , 4 functions, 4 time ranges		16.8 ... 31.2 VDC	250 VAC	6 A	857-604
	Solid-state relay module with 1 make contact , 4 functions, 4 time ranges		20.4 ... 31.2 VDC	0 ... 24 VDC	2 A	857-624
	Solid-state relay module with 1 make contact , 4 functions, 4 time ranges		20.4 ... 31.2 VDC	24 ... 230 VAC	1 A	857-634
	Timer relay module with 1 changeover contact , 14 functions, 8 time ranges		16.8 ... 31.2 VDC	250 VAC	6 A	857-640
	Timer relay module with 1 changeover contact , 7 functions, 2 x 8 time ranges		16.8 ... 31.2 VDC	250 VAC	6 A	857-642

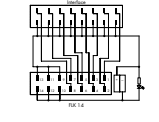
8-Channel Interface Adapter for System Wiring

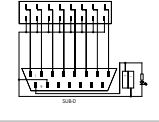
	Description		Nominal Voltage	Current Carrying Capacity per Channel	Limiting Continuous Current	Item No.
	8-channel adapter , with 14-pole interface cable connector, high-side switching input**		24 VDC	1 A	2.5 A	857-981
	8-channel adapter , with 14-pole interface cable connector, high-side switching output***		24 VDC	1 A	2.5 A	857-982
	8-channel adapter , with D-sub male connector, with 15-pole interface cable connector, high-side switching input**		24 VDC	1 A	2.5 A	857-986

**For use on the 857 Series Relay Module's coil side

***For use on the 857 Series Relay Module's contact side

	Assignment of I/O-Modules to Interface Adapters
	750-1500 (16 DO) compatible with 857-981 (DO)
	750-1502 (8 DO / 8 DI) compatible with 857-981 (DO) and 857-982 (DI)











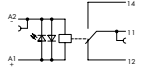

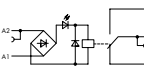

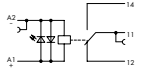

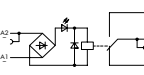
Application example

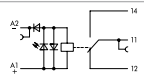
Relay Modules

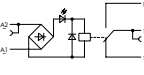
Rail-Mounted Terminal Blocks with a Miniature Switching Relay

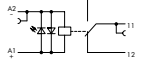
859 Series

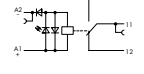
	Description		Input Nominal Voltage U_N	Max. Switching Voltage	Limiting Continuous Current	Item No.
	Relay modules with 1 changeover contact		5 VDC 12 VDC 24 VDC 48 VDC 60 VDC	250 VAC	5 A	859-302 859-303 859-304 859-305 859-306
	Relay modules with 1 changeover contact		12 VAC/DC 24 VAC/DC 48 VAC/DC 115 VAC/DC 230 VAC/DC	250 VAC	5 A	859-353 859-354 859-355 859-357 859-358
	Relay module with 1 changeover contact and gold contacts		24 VDC	250 VAC*	5 A*	859-314
	Relay modules with 1 changeover contact , gold contacts and extended input voltage/temperature range		24 VDC 36 VDC 48 VDC 115 VDC	250 VAC*	3 A*	859-392 859-386 859-384 859-317
	Relay module with 1 changeover contact and gold contacts		230 VAC	250 VAC*	5 A*	859-359
	Relay module with 1 changeover contact and gold contacts		115 VAC	250 VAC*	5 A*	859-360
	Relay module with 1 changeover contact and gold contacts		250 VAC*	250 VAC*	5 A*	859-318
	Relay module with 1 changeover contact		115 VAC	250 VAC	5 A	859-367
	Relay module with 1 changeover contact and defined turn-on/off threshold		230 VAC	250 VAC	5 A	859-368
	Relay module with 1 changeover contact and extended input voltage/temperature range		24 VDC	250 VAC	3 A	859-390
	Relay module with 1 changeover contact and extended input voltage/temperature range		110 VDC	250 VAC	3 A	859-391
	Relay modules with 1 changeover contact and extended input voltage/temperature range		24 VDC 36 VDC 48 VDC 72 VDC 110 VDC	250 VAC	3 A	859-398 859-394 859-397 859-393 859-399

*To prevent damaging the gold layer, 30 VDC switching voltages and 50 mA currents shall not be exceeded. Higher switching power eventually evaporates the gold layer. The resulting deposits in the housing may reduce the service life.

Conductor range (859 Series): 0.08 ... 2.5 mm² / 28 ... 14 AWG
Connection technology (859 Series): CAGE CLAMP® (see page 14)

Marking via Miniature WSB Quick Marking System

For jumpers, see page 204.











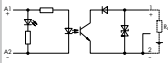

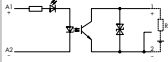

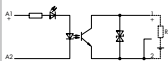
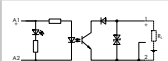

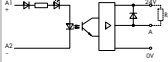

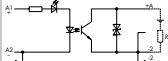
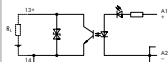
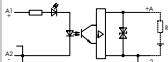

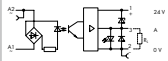
Note:

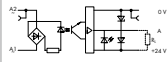
For rail-mounted terminal blocks with overvoltage protection (792 Series), see Full Line Catalog.

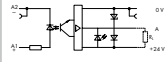
Optocoupler Modules

Rail-Mounted Terminal Blocks with an Optocoupler

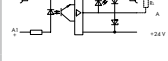
859 Series

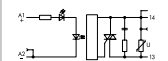
	Description		Input Nominal Voltage U_N	Output Nominal Voltage	Limiting Continuous Current	Item No.
	Optocoupler module with an extended output voltage/temperature range, for railway applications		5 VDC	3 ... 60 VDC	100 mA	859-793
	Optocoupler modules with an extended output voltage/temperature range, for railway applications		24 VDC 24 VDC	7 ... 60 VDC 9 ... 60 VDC	100 mA 100 mA	859-791 859-794
	Optocoupler modules		24 VDC	3 ... 30 VDC	100 mA	859-796
			5 VDC	3 ... 30 VDC	100 mA	859-795
	Power optocoupler module, low-side switching		24 VDC	10 ... 30 VDC	3 A	859-720
	Power optocoupler module		24 VDC	3 ... 30 VDC	3 A	859-730
	Power optocoupler module		24 VDC	3 ... 30 VDC	3 A	859-740
	Power optocoupler module		12 ... 48 VDC	3 ... 53 VDC	4 A	859-744
	Optocoupler module, high-side switching, increased input frequency up to 100 Hz, input voltage up to 270 VAC		230 VAC	20 ... 30 VDC	500 mA	859-772
	Optocoupler modules, low-side switching		24 VDC	20 ... 30 VDC	500 mA	859-712
			5 VDC	20 ... 30 VDC	500 mA	859-702
			24 VDC	20 ... 30 VDC	500 mA	859-708
			24 VDC	4 ... 6.25 VDC	500 mA	859-706
	Optocoupler modules, high-side switching		5 VDC	20 ... 30 VDC	500 mA	859-752
			24 VDC	20 ... 30 VDC	500 mA	859-758
			24 VDC	4 ... 6.25 VDC	500 mA	859-756
	Optocoupler module		5 VDC	24 ... 260 VAC	500 mA	859-902











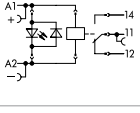
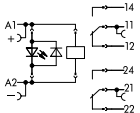

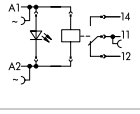
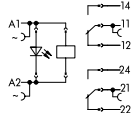

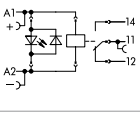
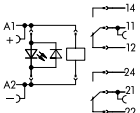
Accessories

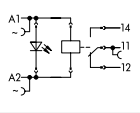
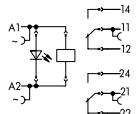
	Description	Item No.
	End and intermediate plate, 1 mm thick, gray	859-525

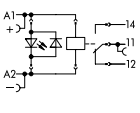
Relay Modules

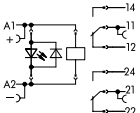
Sockets with a Miniature Switching Relay

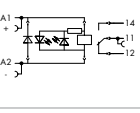
788 Series

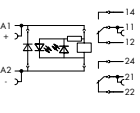
	Description		Input Nominal Voltage U_N	Max. Switching Voltage	Limiting Continuous Current	Item No.
	Relay module with 1 changeover contact and status indication (15 mm high relay)		12 VDC 24 VDC 48 VDC 60 VDC 110 VDC	250 VAC	16 A	788-303 788-304 788-305 788-306 788-307
	Relay module with 2 changeover contacts and status indication (15 mm high relay)		12 VDC 24 VDC 48 VDC 60 VDC 110 VDC	250 VAC	2 x 8 A	788-311 788-312 788-313 788-314 788-315
	Relay module with 1 changeover contact and status indication (15 mm high relay)		24 VAC 115 VAC 230 VAC	250 VAC	16 A	788-506 788-507 788-508
	Relay module with 2 changeover contacts and status indication (15 mm high relay)		24 VAC 115 VAC 230 VAC	250 VAC	2 x 8 A	788-512 788-515 788-516
	Relay module with 1 changeover contact , gold contacts and status indication (15 mm high relay)		24 VDC	250 VAC*	16 A*	788-404
	Relay module with 2 changeover contacts , gold contacts and status indication (15 mm high relay)		24 VDC	250 VAC*	2 x 8 A*	788-412
	Relay module with 1 changeover contact , gold contacts and status indication (15 mm high relay)		115 VAC 230 VAC	250 VAC*	16 A*	788-607 788-608
	Relay module with 2 changeover contacts , gold contacts and status indication (15 mm high relay)		115 VAC 230 VAC	250 VAC*	2 x 8 A*	788-615 788-616
	Relay module with 1 changeover contact and status indication (15 mm high relay)		24 VDC	250 VAC	16 A	788-354
	Safety relay module SR2M with 2 changeover contacts , force-guided contacts and status indication		24 VDC	250 VAC	6 A	788-384
	Relay module with 1 changeover contact , manual operation and status indication (25 mm high relay)		24 VDC	250 VAC	16 A	788-341
	Relay module with 2 changeover contacts , manual operation and status indication (25 mm high relay)		24 VDC	250 VAC	2 x 8 A	788-346







*To prevent damaging the gold layer, 30 VDC switching voltages and 50 mA currents shall not be exceeded.
Higher switching power eventually evaporates the gold layer. The resulting deposits in the housing may reduce the service life.

Conductor range (788 Series): 0.34 ... 2.5 mm² / 22 ... 14 AWG
Connection technology (788 Series): Push-in CAGE CLAMP® (see page 14)
Marking via WMB Multi Marking System and marking strips

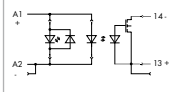

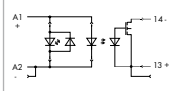

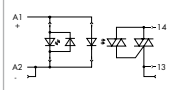

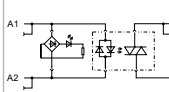
Solid-State Relay Modules

Sockets with a Solid-State Relay

788 Series

	Description		Input Nominal Voltage U_N	Output Nominal Voltage	Limiting Continuous Current	Item No.
	Solid-state relay module		24 VDC	0 ... 24 VDC	3.5 A	788-700
	Solid-state relay module		24 VDC	0 ... 24 VDC	5 A	788-701
	Solid-state relay module		24 VDC	24 ... 240 VAC	1 A	788-720
	Solid-state relay module		24 VAC/DC	12 ... 275 VAC	4 A	788-721







Accessories

	Description		Input Nominal Voltage U_N	Max. Switching Voltage	Limiting Continuous Current	Item No.
	Sockets for miniature switching relays	1 changeover contact, 15 mm high 2 changeover contacts, 15 mm high 1 changeover contact, 25 mm high 2 changeover contacts, 25 mm high	Depending on relay, max. 250 VAC	250 VAC	16 A / 2 x 8 A	788-100 788-102 788-101 788-103
	Status indicators	24 VDC (12 ... 24 V)				788-120
		48 VDC (48 ... 60 V)				788-121
		110 VDC				788-122
		24 VAC				788-123
		115 VAC				788-124
	Suppressor module for relay socket	Max. operating voltage: 230 VAC, 50 ... 60 Hz				788-148
	Pluggable miniature switching relays (15 mm high relay)	1 changeover contact	12 VDC 24 VDC 48 VDC 60 VDC 110 VDC 24 VAC 115 VAC 230 VAC	250 VAC	16 A	788-150 788-154 788-158 788-162 788-166 788-170 788-174 788-178
		2 changeover contacts	12 VDC 24 VDC 48 VDC 60 VDC 110 VDC 24 VAC 115 VAC 230 VAC	250 VAC	2 x 8 A	788-152 788-156 788-160 788-164 788-168 788-172 788-176 788-180
	Push-in type jumper bars, $I_{max.}$ 18 A	2-way 3-way 4-way 6-way 8-way				788-113 788-114 788-115 788-116 788-117
	Operating tool with a partially insulated shaft	Type 2, (3.5 x 0.5) mm blade				210-720

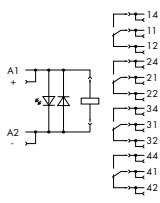
Relay Modules

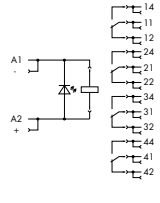

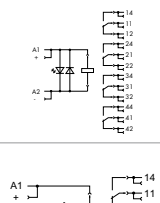

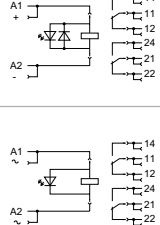
Sockets with an Industrial Relay

858 Series

	Description		Input Nominal Voltage U_N	Max. Switching Voltage	Limiting Continuous Current	Item No.
	Relay module with 4 changeover contacts		24 VDC	250 VAC	4 x 5 A	858-304
	Relay module with 4 changeover contacts and gold contacts		24 VDC	250 VAC*	4 x 5 A*	858-314
	Relay modules with 4 changeover contacts		115 VAC 230 VAC	250 VAC	4 x 5 A	858-507 858-508
	Relay modules with 4 changeover contacts and gold contacts		115 VAC 230 VAC	250 VAC*	4 x 5 A*	858-517 858-518
	Relay modules with 4 changeover contacts and extended input voltage/temperature range, with standard and gold contacts		24 VDC	250 VAC	4 x 5 A	858-354
			24 VDC	250 VAC*	4 x 5 A*	858-355
	Relay modules with 2 changeover contacts		24 VDC	250 VAC	2 x 12 A	858-324
			230 VAC			858-528

*To prevent damaging the gold layer, 30 VDC switching voltages and 50 mA currents shall not be exceeded. Higher switching power eventually evaporates the gold layer. The resulting deposits in the housing may reduce the service life.

Accessories

	Description		Input Nominal Voltage U_N	Max. Switching Voltage	Limiting Continuous Current	Item No.
	Sockets for miniature switching relays	2 and 4 changeover contacts	Depending on relay, max. 250 VAC	250 VAC	4 x 6 A (4 changeover contacts); 2 x 12 A (2 changeover contacts)	858-100
	Pluggable industrial relays	4 changeover contacts	24 VDC 230 VAC 24 VAC	250 VAC	5 A	858-150 858-151 858-154
	Pluggable industrial relays with gold contacts	2 changeover contacts	12 VDC 230 VAC	250 VAC*	5 A*	858-152 858-153
	Push-in type jumper bar, I_N 1 A	Commoning one potential on both control and load side				858-402
	Mounting bracket for industrial relays	(33.5 ... 35.5 mm high)				858-110









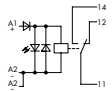
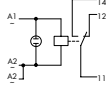
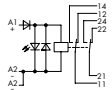
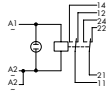

Conductor range (858 Series): 2 x 0.34 ... 2 x 1.5 mm² / 22 ... 16 AWG
Connection technology (858 Series): Push-in CAGE CLAMP® (see page 14)

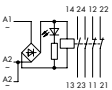
Marking via WMB Multi Marking System and marking strips

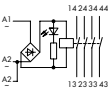
Relay Modules

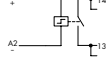
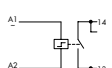
Relay Modules in a DIN-Rail-Mount Enclosure

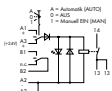
789 Series

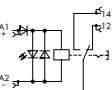
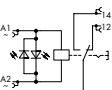
	Description	Input Nominal Voltage U_N	Max. Switching Voltage	Limiting Continuous Current	Item No.	
	Relay module with 1 changeover contact		24 VDC	250 VAC	12 A	789-304
	Relay module with 1 changeover contact		230 VAC	250 VAC	12 A	789-508
	Relay module with 2 changeover contacts		24 VDC	250 VAC	8 A	789-312
	Relay modules with 2 changeover contacts		24 VAC/DC 230 VAC	250 VAC	8 A	789-512 789-516
	Relay modules with 2 break contacts and 2 make contacts		12 VAC/DC 24 VAC/DC	250 VAC	4 AAC	789-535 789-536
	Relay modules with 4 make contacts		12 VAC/DC 24 VAC/DC	250 VAC	4 AAC	789-551 789-552
	Latching relay module with 1 make contact		24 VDC	250 VAC	16 A	789-571
	Latching relay module with 1 make contact		230 VAC	250 VAC	16 A	789-570
	Relay modules with 1 make contact and Manual/OFF/Auto switch		24 VDC	250 VAC	16 A	789-323
	Relay modules with 1 make contact and Manual/OFF/Auto switch, with control contact		24 VDC	250 VAC	16 A	789-325
	Relay module with 1 changeover contact and manual operation		24 VDC	250 VAC	12 A	789-1341
	Relay module with 1 changeover contact and manual operation		230 VAC	250 VAC	12 A	789-1544

Conductor range (789 Series): 0.08 ... 2.5 mm² / 28 ... 14 AWG

Connection technology (789 Series): CAGE CLAMP® (see page 14)

Marking via Miniature WSB Quick Marking System









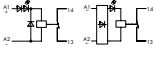
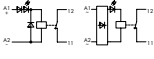

Jumper for 789 Series

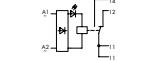
	Description	Item No.
	Push-in type jumper bar, I_N 16 A, 12-way, to be cut to the required length	789-112

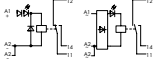

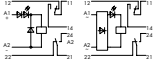

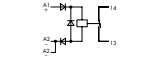
Relay Modules

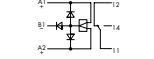
Mounting Carriers with a Miniature Switching Relay

288 Series

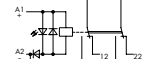
	Description		Input Nominal Voltage U_N	Max. Switching Voltage	Limiting Continuous Current	Item No.
	Relay modules with 1 make contact , relay pre-soldered onto mounting carrier		24 VDC 24 VAC/DC 48 VAC/DC 115 VAC/DC	250 VAC	5 A	288-364 288-564 288-565 288-567
	Relay modules with 1 break contact , relay pre-soldered onto mounting carrier		24 VDC 24 VAC/DC	250 VAC	5 A	288-368 288-568
	Relay module with 1 changeover contact , relay pre-soldered onto mounting carrier, with pluggable connectors		24 VAC/DC	250 VAC	5 A	288-554
	Relay modules with 1 changeover contact , relay pre-soldered onto mounting carrier		24 VDC 24 VAC/DC 230 VAC	250 VAC	6 A	288-304 288-504 288-508
	Relay modules with 2 changeover contacts , relay pre-soldered onto mounting carrier		24 VDC 24 VAC/DC	250 VAC	6 A	288-312 288-512
	Relay module with 1 make contact , relay pre-soldered onto mounting carrier, switches high inrush current loads (e.g., filament lamp loads)		24 VDC	250 VAC	16 A	288-320
	Bistable relay module with 1 changeover contact , relay pre-soldered onto mounting carrier		24 VDC	250 VAC	6 A	288-380

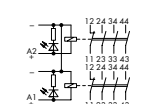
Relay Modules with Force-Guided Contacts

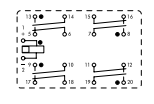
	Description		Input Nominal Voltage U_N	Max. Switching Voltage	Limiting Continuous Current	Item No.
	Relay module with 2 changeover contacts and force-guided contacts, relay pre-soldered onto mounting carrier		24 VDC	250 VAC	5 A	288-437
	2 safety relay modules Hengstler H-462, with 3 make contacts and 1 break contact , pre-mounted on carrier		24 VDC	250 VAC	6 A	288-435
	Safety relay modules SDS SF 4, with 4 break contacts and 4 make contacts , 1 relay pre-soldered onto mounting carrier		5 VDC 12 VDC 24 VAC/DC 48 VAC/DC 230 VAC/DC	250 VAC	6 A	288-412 288-413 288-414 288-415 288-418

Conductor range (288 Series): 0.08 ... 2.5 mm² / 28 ... 14 AWG
 Connection technology (288 Series): CAGE CLAMP® (see page 14)

Marking using WMB Multi markers

Relay Modules

Technical Information

Contact Material

For a contact reliability, the contact resistance over the entire operating life of the relay should remain relatively low and constant. A variety of contact materials can be selected depending on the load type, switching current, switching voltage and the desired number of switching cycles. The accompanying table shows the materials with the typical features and application notes that are used for the WAGO relay modules.

Contact Protective Circuit

When switching off inductive loads, such as contactors and solenoid valves, transients occur with peak voltages up to several thousand volts. These transients often exceed the permissible EMC standard limits and must therefore be limited by external circuits. They also cause an electric arc at the switching contact, which can destroy the contact or can significantly diminish the relay's service life and reliability. The following protective circuits, which are outlined in the table, are connected directly to the source in parallel to the load and have proven to be successful.

Service Life

A distinction must be made between the mechanical life, which indicates the number of switching cycles without contact load, and the electrical service life at maximum load, which indicates the number of switching cycles with maximum switching power and resistive load. Reduced power increases the service life compared to the value of the maximum load. The following figure shows the typical curve between switching current and service life of a relay.

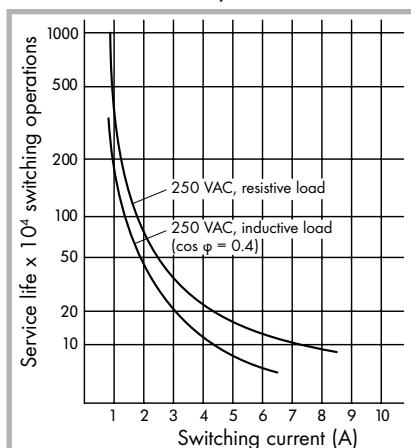











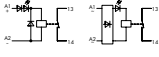
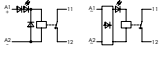

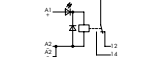
Contact material	Features and Application	Application Range
AgNi 0.15 + 5 μ Au	Excellent corrosion resistance, low and constant contact resistances at extremely low switching power, for dry circuits	μ V ... 30 V μ A ... 0.2 A
AuAg 10 via AgNi 15 + Au	Behavior as a 5 μ gold contact, but 5 times higher wear resistance, for all circuits from μ W range up to 100 W or 1 kVA	100 mV/10 μ A
AgCd O + 1 μ Au	Low welding tendency, high burn-off resistance at higher switching power, suitable for small switching loads	\geq 5 V \geq 10 mA
Ag Cd O, with gold flash	Low welding tendency, high burn-off resistance at higher switching power, Au as storage protection	\geq 12 V \geq 100 mA
Ag Ni 0.15 + HV	Good mechanical stability, low welding tendency and low contact resistance, universal use at moderate loads	\geq 12 V 5 mA ... 10 A
Ag Sn O ₂	Low welding tendency, extremely high burn-off resistance at high switching power, suitable for circuits with high switch on/off loads, DC circuits	\geq 5 V/100 mA \geq 10 V/10 mA \geq 24 V/1 mA
Ag alloy, with gold flash	Good mechanical stability, low welding tendency, large application range for small to medium switching power	10 ⁻³ W

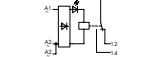
Load Circuit	Additional Fall Delay	Defined Induction Voltage Limitation	Bipolar-Effective Attenuation	Advantages:	Disadvantages:
Diode 	Large	Yes (U_D)	No	<ul style="list-style-type: none"> Easy implementation Cost-effective, reliable Uncritical dimensioning Small induction voltages 	<ul style="list-style-type: none"> Attenuation only via load resistor
Diode/Zener Diode Series Circuit 	Medium to small	Yes (U_{ZD})	No	<ul style="list-style-type: none"> Uncritical dimensioning 	<ul style="list-style-type: none"> Attenuation only above U_{ZD}
Suppressor Diode 	Medium to small	Yes (U_{ZD})	Yes	<ul style="list-style-type: none"> Cost-effective Uncritical dimensioning Limitation of positive peaks Suitable for AC voltage 	<ul style="list-style-type: none"> Attenuation only above U_{ZD}
Varistor 	Medium to small	Yes (U_{VDR})	Yes	<ul style="list-style-type: none"> High energy absorption Uncritical dimensioning Suitable for AC voltage 	<ul style="list-style-type: none"> Attenuation only above U_{VDR}
R/C Combination 	Medium to small	No	Yes	<ul style="list-style-type: none"> RF attenuation via power storage Suitable for AC voltage Level-dependent attenuation 	<ul style="list-style-type: none"> Accurate dimensioning required High inrush current

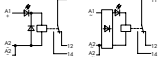
Relay Modules

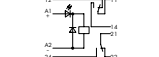
Pluggable Relay Modules for Carrier Terminal Blocks

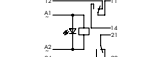
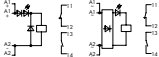
286 Series

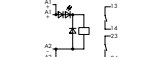
	Description		Input Nominal Voltage U_N	Max. Switching Voltage	Limiting Continuous Current	Item No.
	Relay module with 1 make contact ①		24 VDC	250 VAC	5 A	286-364
	Relay module with 1 break contact ①		24 VDC	250 VAC	5 A	286-368
	Relay module with 1 changeover contact ②		24 VDC	250 VAC	7 A	286-304
	Relay modules with 1 changeover contact ②		115 VAC 230 VAC	250 VAC	7 A	286-507 286-508
	Relay modules with 1 changeover contact and gold contacts ②		24 VDC 24 VAC/DC	250 VAC*	1 A*	286-394 286-594
	Relay modules with 2 changeover contacts ③		24 VDC 110 VDC 220 VDC	250 VAC	7 A	286-312 286-315 286-316
	Relay modules with 2 changeover contacts ③		24 VAC 115 VAC 230 VAC	250 VAC	7 A	286-512 286-515 286-516
	Relay module with 1 break contact and 1 make contact ③		24 VDC	250 VAC	6 A	286-320
	Relay module with 2 make contacts ④		24 VDC	250 VAC	6 A	286-328

*To prevent damaging the gold layer, 30 VDC switching voltages and 50 mA currents shall not be exceeded.

Higher switching power eventually evaporates the gold layer. The resulting deposits in the housing may reduce the service life.

Marking via 4 mm WSB marker cards









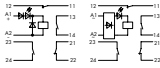

① ... ⑤: For compatible terminal blocks, see page 219.

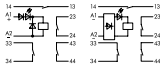

Relay Modules

Pluggable Relay Modules for Carrier Terminal Blocks

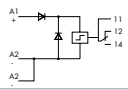
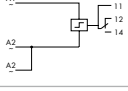
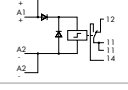

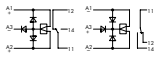
286 Series

	Description		Input Nominal Voltage U_N	Max. Switching Voltage	Limiting Continuous Current	Item No.
	Relay module with 1 break contact and 3 make contacts ④		230 VAC	250 VAC	5 A	286-548
	Relay module with 4 make contacts ④		115 VAC	250 VAC	5 A	286-555
	Relay module with 4 changeover contacts ⑤		230 VAC	250 VAC	4 AAC	286-579
	Relay module with 1 make contact , switches higher DC loads ②		24 VDC	250 VAC	5 A	286-376
	Latching relay with 1 changeover contact ②		24 VDC	250 VAC	5 A	286-573
			230 VAC			286-574
	Latching relay with 1 changeover contact , for railway applications ②		24 VDC	250 VAC	3 A (6 A up to +50 °C)	286-575
	Bistable relay modules with 1 changeover contact , high-side/low-side switching ②		24 VDC 24 VDC	250 VAC	6 A	286-380 286-381

Terminal Blocks for Pluggable Modules

0.08 ... 2.5 mm² / 28 ... 14 AWG

CAGE CLAMP®











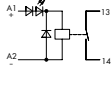

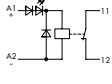

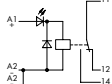

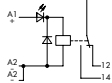

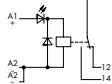
	Description	Width	Item No.	Assignment	
	Terminal blocks for pluggable modules with 2-conductor blocks	Orange separator plate	12 mm	○ 280-618	①
			17 mm	○ 280-619	②
			22 mm	○ 280-638	③
			27 mm	○ 280-639	④
	Terminal blocks for pluggable modules with 4-conductor blocks	Orange separator plate	12 mm	○ 280-608	①
		Marking plate	15 mm	○ 280-762	①
		Orange separator plate	17 mm	○ 280-609	②
		Marking plate	20 mm	○ 280-763	②
		Orange separator plate	22 mm	○ 280-628	③
		Marking plate	25 mm	○ 280-764	③
		Orange separator plate	27 mm	○ 280-629	④
		Marking plate	30 mm	○ 280-765	④
Orange separator plate	37 mm	○ 280-636	⑤		

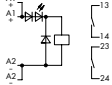
For information on CAGE CLAMP® connection, see page 14.

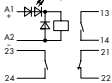
Relay Modules

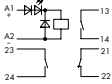
Pluggable Relay Modules for Carrier Terminal Blocks

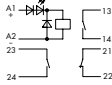
286 Series

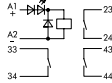
	Description		Input Nominal Voltage U_N	Max. Switching Voltage	Limiting Continuous Current	Item No.
	Relay module with 1 changeover contact and extended input voltage/temperature range 1		24 VDC	250 VAC	3 A	286-364/004-000
	Relay module with 1 break contact and extended input voltage/temperature range		24 VDC	250 VAC	3 A	286-368/004-000
	Relay module with 1 changeover contact and extended input voltage/temperature range 2		24 VDC 110 VDC	250 VAC	3 A	286-304/004-000
	Relay module with 1 changeover contact and extended input voltage/temperature range 2		24 VDC	250 VAC*	3 A*	286-307/004-000
	Relay module with 1 changeover contact and extended input voltage/temperature range 2		24 VDC	250 VAC	4 A	286-394/004-000
	Relay module with 2 break contacts and extended input voltage/temperature range 3		24 VDC	250 VAC	4 A	286-312/004-000
	Relay module with 1 break contact, 1 changeover contact and extended input voltage/temperature range 3		24 VDC	250 VAC	4 A	286-320/004-000
	Relay module with 2 make contacts and extended input voltage/temperature range 3		24 VDC	250 VAC	4 A	286-328/004-000
	Relay module with 2 break contacts, 2 make contacts and extended input voltage/temperature range 4		24 VDC	250 VAC	4 A	286-336/001-000
	Relay module with 3 make contacts, 1 break contact and extended input voltage/temperature range 4		24 VDC	250 VAC	4 A	286-344/004-000











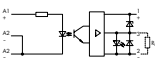

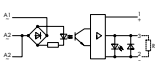
*To prevent damaging the gold layer, 30 VDC switching voltages and 50 mA currents shall not be exceeded. Higher switching power eventually evaporates the gold layer. The resulting deposits in the housing may reduce the service life.

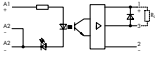
1 ... **5**: For compatible terminal blocks, see page 219.

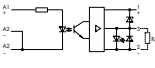
Optocoupler Modules

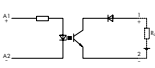
Pluggable Optocoupler Modules for Carrier Terminal Blocks

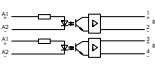

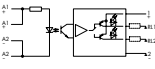
286 Series

	Description		Input Nominal Voltage U_N	Output Nominal Voltage	Limiting Continuous Current	Item No.
	Optocoupler modules, high-side switching ②		24 VDC	3 ... 6 VDC 10 ... 20 VDC 20 ... 30 VDC	500 mA	286-750 286-751 286-752
	Optocoupler modules, high-side switching ②		230 VAC	3.5 ... 7 VDC 10 ... 20 VDC	500 mA	286-754 286-756
	Optocoupler modules, low-side switching ②		24 VDC	15 ... 40 VDC	2 A	286-720
			24 VDC	15 ... 40 VDC	5 A	286-721
	Optocoupler modules, high-side switching ②		5 VDC	20 ... 30 VDC	500 mA	286-752/002-000
			24 VDC	20 ... 30 VDC	4 A	286-723
	Optocoupler module ①		24 VDC	20 ... 60 VDC	100 mA	286-791
	Dual-channel, optocoupler module ③		2 x 24 VDC	2 x 20 ... 30 VDC	2 x 250 mA	286-792
	Optocoupler module, with 2 inverted outputs ③		24 VDC	20 ... 30 VDC	500 mA	286-790

Terminal Blocks for Pluggable Modules

0.08 ... 2.5 mm² / 28 ... 14 AWG

CAGE CLAMP®



	Description	Width	Item No.	Assignment	
	Terminal blocks for pluggable modules with 2-conductor blocks	Orange separator plate	12 mm	○ 280-618	①
		Orange separator plate	17 mm	○ 280-619	②
		Orange separator plate	22 mm	○ 280-638	③
		Orange separator plate	27 mm	○ 280-639	④
	Terminal blocks for pluggable modules with 4-conductor blocks	Orange separator plate	12 mm	○ 280-608	①
		Marking plate	15 mm	○ 280-762	①
		Orange separator plate	17 mm	○ 280-609	②
		Marking plate	20 mm	○ 280-763	②
		Orange separator plate	22 mm	○ 280-628	③
		Marking plate	25 mm	○ 280-764	③
		Orange separator plate	27 mm	○ 280-629	④
		Marking plate	30 mm	○ 280-765	④
Orange separator plate	37 mm	○ 280-636	⑤		

For information on CAGE CLAMP® connection, see page 14.

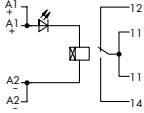

Pluggable Timer Relay Modules for Carrier Terminal Blocks, Specialty Relay Modules, Surge Suppression Modules

286 Series

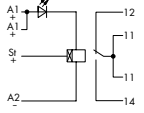



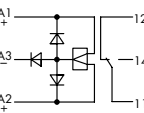
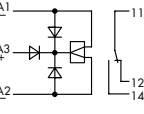

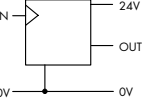

Pluggable Timer Relay Modules for Carrier Terminal Blocks

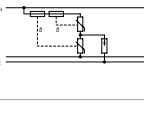
	Description		Input Nominal Voltage U_N	Max. Switching Voltage	Time Range	Item No.
	Pulse time delay relay module, 1 changeover contact ②		24 VDC	380 VAC	0.1 ... 1 s	286-460
					1 ... 10 s	286-462
					10 ... 100 s	286-464
	Multifunction timer relay module, 4 time ranges, 4 functions, 1 changeover contact ②		24 VDC	380 VAC	0.3 ... 3 s, 3 ... 12 s, 10 ... 100 s, 100 ... 800 s	286-640

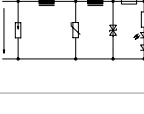
Specialty Relay Modules

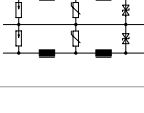
	Description		Input Nominal Voltage U_N	Max. Switching Voltage	Nominal Current I_N	Item No.
	Bistable relay module, high-side switching, 1 changeover contact ①		24 VDC	250 VAC	41.4 mA	286-380
	Bistable relay module, low-side switching, 1 changeover contact ①		24 VDC	250 VAC	41.4 mA	286-381
	Flip-flop module ①		24 VDC	24 VDC	500 mA	286-825

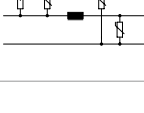
Surge Suppression Modules

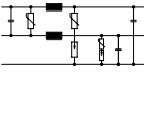



	Description		Nominal Operating Voltage U_N	Operating Voltage	Nominal Current I_N	Item No.
	Single-stage suppression for 2-pole control and power circuits ①		230 VAC	300 VAC	10 A	286-838
			115 VAC	150 VAC		286-838/115-000
	Three-stage suppression for 1-pole data, measurement and control circuits ②		24 DC	30 VDC	0.1 A	286-833
	Three-stage suppression for 2-pole data, measurement and control circuits ②		12 VDC	14 VDC	6 A	286-834
			24 VDC	30 VDC		286-834/024-000
	Two-stage suppression for 2-pole data, measurement, control and power circuits ②		24 VAC/DC	30 VAC / 38 VDC	6 A	286-831
			24 VAC/DC	30 VAC / 38 VDC		286-832
	Two-stage suppression for 2-pole data, measurement, control and power circuits, with filter ③		110 VDC	180 VDC	6 A	286-844
			115 VAC	140 VAC		286-843
			220 VDC	320 VDC		286-841
			230 VAC	250 VAC		286-842

① ... ⑤: For compatible terminal blocks, see page 219.



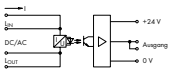

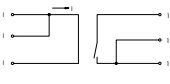

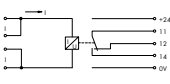

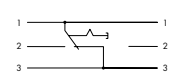

Current Flow Monitoring Modules, Specialty Modules

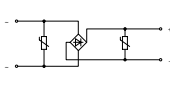
286 Series

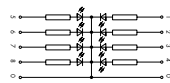
Current Flow Monitoring Modules

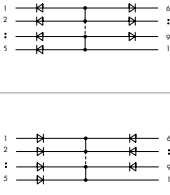
	Description		Current Monitoring Range	Voltage Range	Item No.
	AC/DC current flow monitoring module 2		16 mADC / 35 ... 300 mAAC	10 ... 250 VAC/DC	286-659
	DC current flow monitoring module, 1 make contact 1		0.4 ... 3.5 ADC (-20 ... +40 °C) 0.4 ... 3 ADC (-20 ... +60 °C) 0.4 ... 2 ADC (-20 ... +70 °C)	12 ... 28 VDC	286-662
	AC current flow monitoring module, 1 changeover contact 3		0.2 ... 3 AAC (adjustable)		286-664

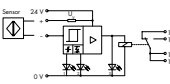
Specialty Modules

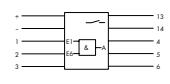
	Description		Operating Voltage	Characteristics		Item No.
	Switching modules, 1-pole, with changeover rocker switch 1		24 VDC / 250 VAC	Switching current, resistive AC 6 A	Switching current, inductive AC 4 A	286-895
			24 VDC / 250 VAC	Switching current, resistive AC 6 A	Switching current, inductive AC 4 A	286-896
	Bridge rectifiers, with varistor protection 1		24 VAC	Nominal current 1 A	Max. charging capacitator 2200 µF	286-830
			250 AC	Nominal current 1 A	Max. charging capacitator 500 µF	286-840
	LED gate module, with 8 LEDs, common cathode 3		24 VDC	Power consumption at V_N 5.1 mA each LED		286-822
	Diode gate modules		250 VAC/DC	Common anode	3 diodes 1	286-803
					5 diodes 1	286-805
					7 diodes 2	286-807
					9 diodes 3	286-809
				Common cathode	3 diodes 1	286-813
					5 diodes 1	286-815
					7 diodes 2	286-817
					9 diodes 3	286-819
	NAMUR switching amplifier 2		34 VDC	With transistor output		286-881
	AND gate module with 6 inputs, relay output with 1 make contact 3		24 VDC	Max. switching voltage 250 VAC / 120 VDC	Max. continuous current 3 A	286-826

Power and Energy Measurement ...

... via 3-Phase Power Measurement Modules from the WAGO-I/O-SYSTEM 750

General Configurations

Power and energy measurement of a machine in a 480 VAC mains network via 750-493 or 750-494 3-Phase Power Measurement Modules

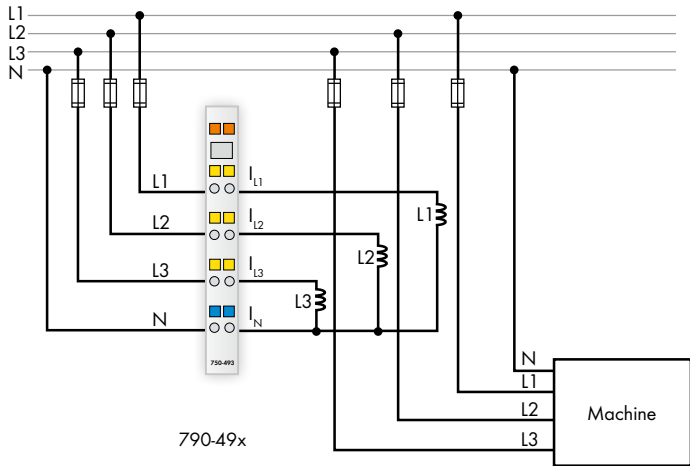

Power, energy and N-conductor measurement of a machine in a 480/690 VAC mains network via 750-495 3-Phase Power Measurement Module

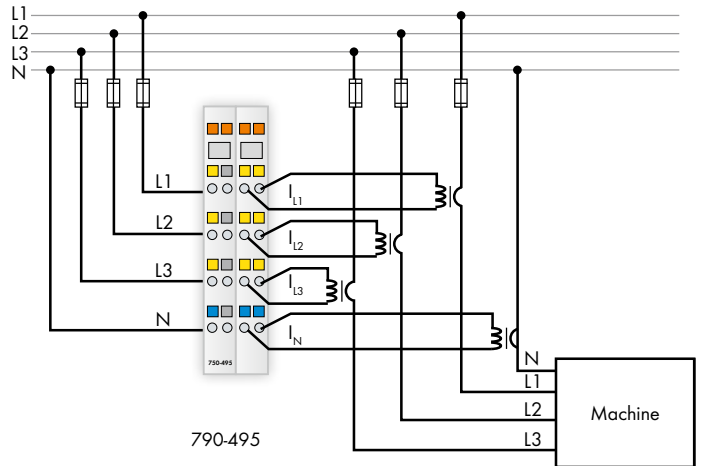

Applications

Connecting current transformers to 3-Phase Power Measurement Modules

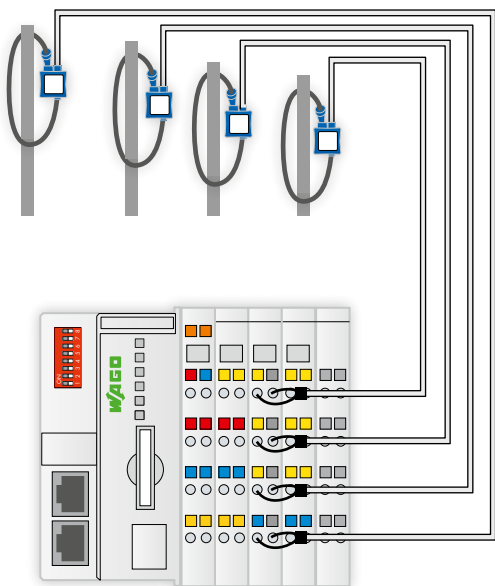

2007-8873 Terminal Block Assembly for Current Transformers

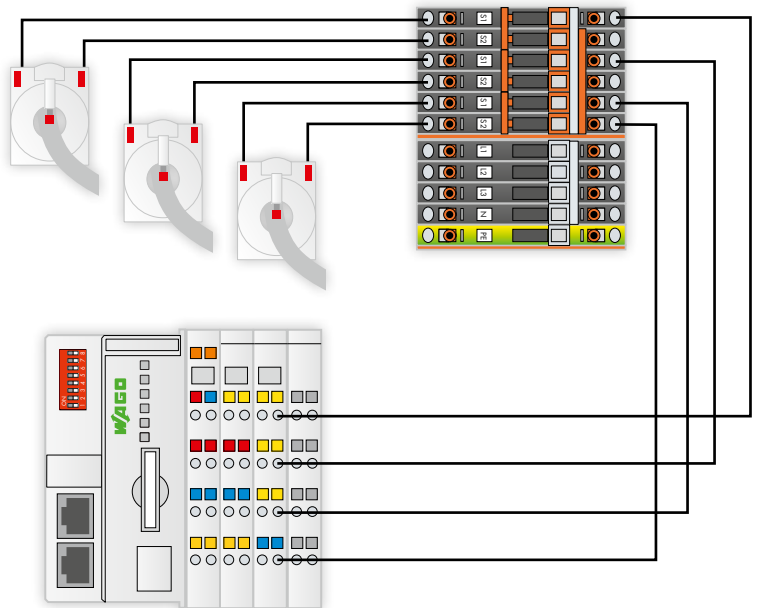

Connecting Rogowski coils directly to the 750-495/000-002 3-Phase Power Measurement Module

Power and Energy Measurement

Comprehensive Network Analysis via WAGO-I/O-CHECK

Overview: Three Phases' Measured Values

Phase	Active Power (W)	Reactive Power (var)	Apparent Power (VA)	Power Factor PF
Phase L1	216.8	-10.1	217.03	0.707
Phase L2	330	50	680	0.99
Phase L3	62.26	-2.52	62.31	0.99

Phase	Current (A)
Phase L1	0.261
Phase L2	0.514
Phase L3	0.134

Phase	Voltage (V)
Phase L1	238.39
Phase L2	238.62
Phase L3	238.55

xEnable	xReady
enumMeasuredValue1	bFeedback
enumMeasuredValue2	rMeasuredValue1
enumMeasuredValue3	rMeasuredValue2
enumMeasuredValue4	rMeasuredValue3
abIn_750_494	rMeasuredValue4
abOut_750_494	
bToken	

Measured value configuration is also possible via function block.

Harmonic Diagram

Order	Value
2	0.005
3	0.004
4	0.003
5	0.003
6	0.003
7	0.003
8	0.003
9	0.003
10	0.003
11	0.003
12	0.001
13	0.001
14	0.001
15	0.001
16	0.001
17	0.001
18	0.001
19	0.001
20	0.001
21	0.001
22	0.001
23	0.001
24	0.001
25	0.001
26	0.001
27	0.001
28	0.001
29	0.001
30	0.001
31	0.001
32	0.001
33	0.001
34	0.001
35	0.001
36	0.001



Parameter	Value
Frequency	49.99 Hz
Current Frequency	49.99 Hz
Maximum Frequency	49.99 Hz
Minimum Frequency	49.99 Hz
Total Harmonic Distortion (THD)	
Voltage	
Current	

Measured Value Chart

Plug-In Current Transformers with CAGE CLAMP® Connection 855 Series

	Primary Rated Current	Secondary Rated Current	Rated Power	Accuracy Class	Hole for Conductor/Cable	Item No.
	50	1	1,25	3	Current bar 1: 30 x 10 mm Current bar 2: 25 x 12 mm Current bar 3: 20 x 20 mm Round cable: 26 mm	855-301/050-103
	50	5	1,25	3		855-305/050-103
	60	1	1,25	1		855-301/060-101
	60	5	1,25	1		855-305/060-101
	75	1	2,5	1		855-301/075-201
	75	5	2,5	1		855-305/075-201
	100	1	2,5	1		855-301/100-201
	100	5	2,5	1		855-305/100-201
	150	1	5	1		855-301/150-501
	150	5	5	1		855-305/150-501
	200	1	5	1		855-301/200-501
	200	5	5	1		855-305/200-501
	250	1	5	1		855-301/250-501
	250	5	5	1		855-305/250-501
	400	1	10	1		855-301/400-1001
	400	5	10	1		855-305/400-1001
	600	1	10	1		855-301/600-1001
	600	5	10	1		855-305/600-1001
	250	5	5	1		855-405/250-501
	400	1	5	1		855-401/400-501
	400	5	5	1	855-405/400-501	
	600	1	5	1	855-401/600-501	
	400	5	10	1	855-505/400-1001	
	600	5	10	1	855-505/600-1001	
	800	5	10	1	855-505/800-1001	
	1000	1	10	1	855-501/1000-1001	
	1000	5	10	1	855-505/1000-1001	
	1500	5	5	1	855-605/1500-501	
1500	1	5	1	855-601/1500-501		
2000	5	10	1	855-805/2000-1001		
2000	1	10	1	855-801/2000-1001		
2500	5	10	1	855-1005/2500-1001		
2500	1	10	1	855-1001/2500-1001		

Accessories

	Description	Item No.
	Carrier Rail Adapter for Plug-In Current Transformers (855-3xx and 855-4xx)	855-9900
	Quick-Mount Kit (2 pieces including cable tie)	855-9910



Snapping the carrier rail adapter onto the plug-in current transformer.



Securing the round cable via locking screw.



Inserting a conductor via operating tool.

Split-Core Current Transformers with a Connection Cable 855 Series



	Primary Rated Current	Secondary Rated Current	Rated Power	Accuracy Class	Cable Length	Hole for Conductor/Cable	Item No.	
	60 A	1 A	0.2 VA	3	3 m	18 mm Ø	855-3001/060-003	
	100 A	1 A	0.2 VA	3	3 m		855-3001/100-003	
	200 A	1 A	0.2 VA	1	3 m		855-3001/200-001	
	250 A	1 A	0.2 VA	1	3 m		855-3001/250-001	
	100 A	1 A	0.2 VA	1	3 m	18 mm Ø	855-4001/100-001	
	150 A	1 A	0.2 VA	1	3 m		855-4001/150-001	
	150 A	5 A	1 VA	1	0.5 m		855-4005/150-101	
	200 A	1 A	0.2 VA	0.5	3 m		855-4001/200-001	
	200 A	1 A	0.2 VA	1	3 m	28 mm Ø	855-4101/200-001	
	250 A	1 A	0.2 VA	1	3 m		855-4101/250-001	
	250 A	5 A	1 VA	1	0.5 m		855-4105/250-101	
	400 A	1 A	0.2 VA	1	3 m		855-4101/400-001	
	400 A	5 A	1 VA	1	0.5 m		855-4105/400-101	
	250 A	1 A	0.5 VA	1	5 m	42 mm Ø	855-5001/250-001	
	400 A	1 A	0.5 VA	0.5	5 m		855-5001/400-000	
	400 A	5 A	0.5 VA	1	3 m		855-5005/400-001	
	600 A	1 A	0.5 VA	0.5	5 m		855-5001/600-000	
	600 A	5 A	0.5 VA	0.5	3 m		855-5005/600-000	
	1000 A	1 A	0.5 VA	0.5	5 m		855-5001/1000-000	
	1000 A	5 A	0.5 VA	0.5	3 m		855-5005/1000-000	
	1000 A	1 A	0.5 VA	0.5	5 m	2 x 42 mm Ø	855-5101/1000-000	
	1000 A	5 A	0.5 VA	0.5	3 m		855-5105/1000-000	

WAGO's compact 855 Series Split-Core Current Transformers are ideal for retrofitting existing systems. They are perfect for applications in which the current path must not be disrupted. The transformer's accuracy permits extremely precise current measurements.



The split-core current transformers are capable of supplying the specified rated power at the end of the secondary cable. All transformers are supplied with color-coded cables. Two UV-resistant cable ties are also included for secure and easy mounting.



Plug-In Current Transformers with a *picoMAX*[®] Pluggable Connector 855 Series

	Primary Rated Current	Secondary Rated Current	Rated Power	Accuracy Class	Conductor Hole	Item No.
	32 A*	0.32 A	0.01 VA (0.1 Ω)	0.5**	5.0 mm ∅	855-1700/032-000
	35 A	1 A	0.2 VA	1	7.5 mm ∅	855-2701/035-001
	64 A	1 A	0.2 VA	1	7.5 mm ∅	855-2701/064-001

Accessories

	Description		Item No.
	Carrier Rail Adapter	for 855-2701/xxx	855-9927
	Operating Tool	Type 2, (3.5 x 0.5) mm blade	210-720

*Measurement range: 0.8 ... 32 A in combination with 750-493/494/495 3-Phase Power Measurement Modules

**Testing adheres to EN 61869-2 with a conversion ratio of 16 A/0.16 A (accuracy class: 0.5) and an extended primary current of 200 %.



Snapping a transformer onto DIN-rail.



Staggered arrangement for 17.5 mm spacing



Inserting a conductor via push-in termination.



Removing the conductor via push-button.





Low power output



1A output

Intelligent Current Sensors with Bus Connection 789 Series

WAGO's intelligent current sensors monitor solar plants or inverters for DC measurements within a large current measurement range.

	Measurement Range	Transmission Error	Power Supply	Hole	Interface	Protocol	Addressing	Max. Bus Length	Item No.
	0 ... 80 ADC	≤ 0.5 % of upper-range value	12 ... 34 V (via RJ-45)	15 mm (for power cable)	RS-485	MODBUS over serial line	1 ... 32	≤ 1,200 m	789-620
	0 ... 140 ADC								789-621
	0 ... 50 A _{rms} (AC)								789-622

Rogowski Coils

855 Series

	Primary Rated Current	Output Signal	Description	Item No.
	500 A	10.05 mV	RT 500, 1.5 m cable	855-9100/500-000
			RT 500, 3 m cable	855-9300/500-000
	2000 A	40.2 mV	RT 2000, 1.5 m cable	855-9100/2000-000
			RT 2000, 3 m cable	855-9300/2000-000





Function: The Rogowski coil is a closed-air coil with a non-magnetic split core. The coil is placed around a cable or current bar. The magnetic field produced by the AC current flowing through the conductor induces an output voltage in the coil. This measurement procedure galvanically isolates the primary circuit (power) and secondary circuit (measurement).

Accessories: Signal Conditioners for Rogowski Coils

	Input Signal	Output Signal	Overcurrent	Sensitivity	Item No.
	3 x RT 500 (500 A)	3 x 100 mAAC	750 A	10.05 mV; 50 Hz, sinusoidal	789-652
	3 x RT 2000 (2,000 A)		3000 A	40.2 mV; 50 Hz, sinusoidal	789-654

Voltage Taps

	Color	Hole for Measurement Conductor	Fuse	Item No.
	Black	3 ... 5 mm Ø	2 A, 450 V, F, 70 kA, 5 x 25 mm	855-8001
	Blue		-	855-8002
	Black	5 ... 7 mm Ø	2 A, 450 V, F, 70 kA, 5 x 25 mm	855-8003
	Blue		-	855-8004

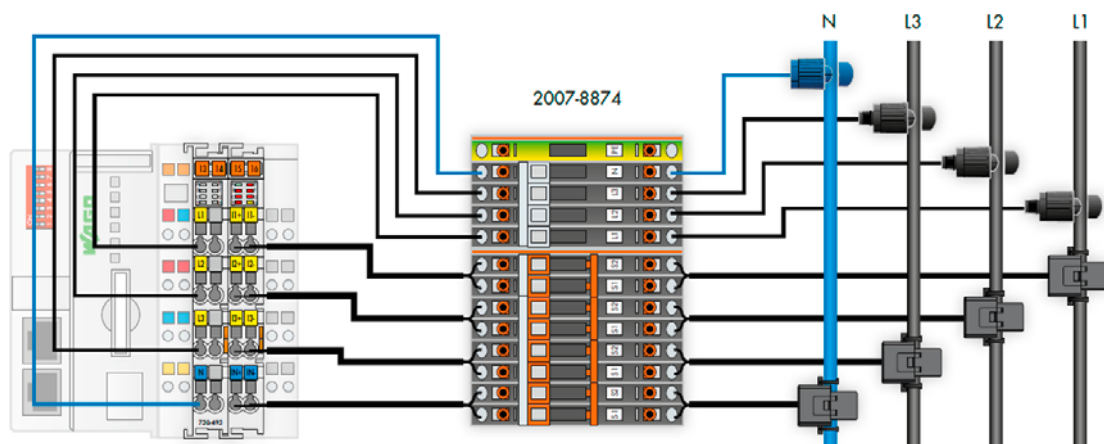

WAGO System Wiring and Interface Modules - Overview and Application Examples -

16-Channel Module with Interface Module

The new 750-14xx and 750-15xx Series Bus Modules with a pluggable connector per DIN 41 651 offer 16 digital channels in a module less than 1/2 inch (12 mm) wide. Offering quick connections and a space-efficient design, the DIN-rail-mount interface modules simplify installation in confined areas and conveniently relocate the termination point. When combined with WAGO interface modules (e.g., item no. 289-614, 289-611), a switch cabinet can be pre-wired before installation to minimize wiring time and errors. This is beneficial as wiring can be performed independently of construction.

Pre-wired electronics can be installed right before start, saving valuable time during the final stages of project completion. The modules are also ideal for connecting series machines or relay modules tasked with the higher loads common to buildings and industrial applications. The interface module also combines the advantages of relays (e.g., manual operation or rapid replacement via socket-mounted versions) with the benefits of a modern I/O system. Another ideal application would be the integration of pneumatic controllers into a fieldbus network.

Most pneumatic modules have an appropriate connector and can be controlled by the WAGO I/O-SYSTEM. Five variants are available: two 16-channel input or output modules (one high-side and one low-side switching variant), as well as a version combining 8 inputs and 8 outputs.

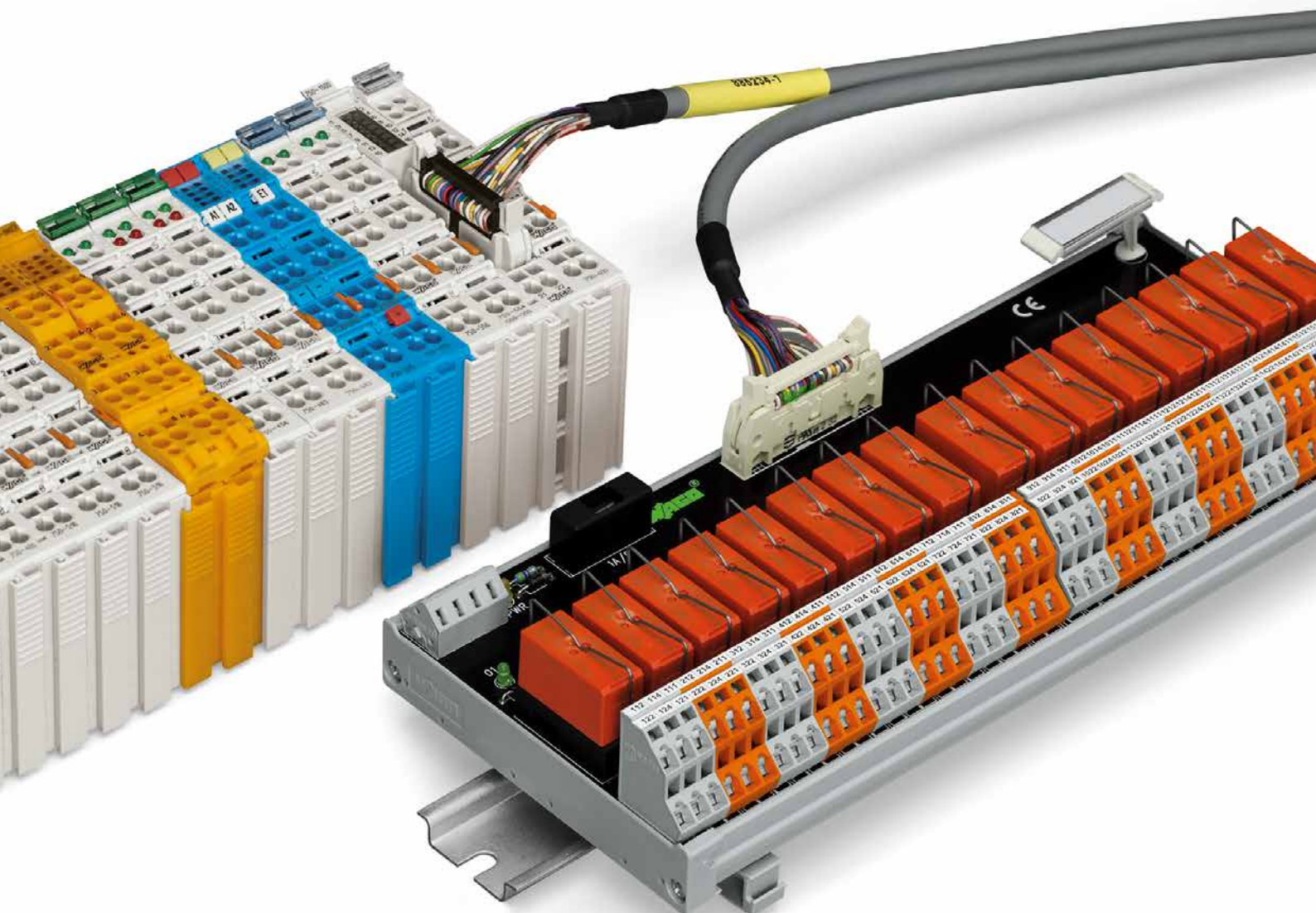



WAGO Interface Cable,
706-7753/302-100



WAGO Interface Cable,
706-7753/300-100

288/289 Series DIN-Rail-Mount Relay Modules

Examples:

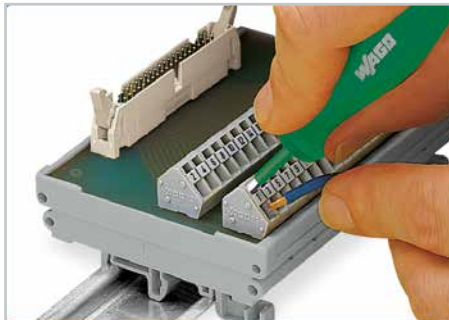

"Front-entry" conductor termination

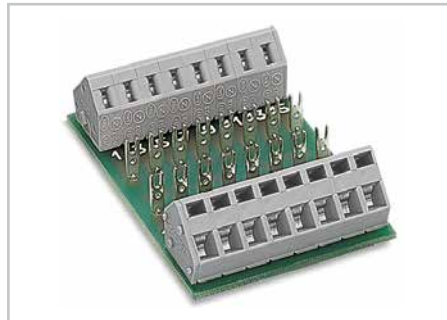

Solder pins for self-assembly



Relay module, 8 channels

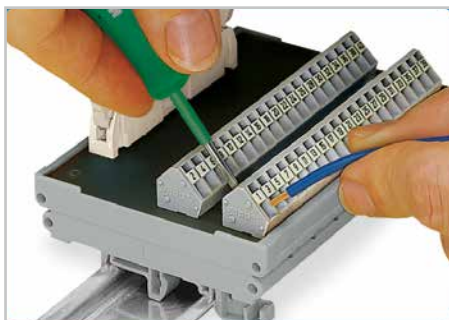

"Side-entry" conductor termination

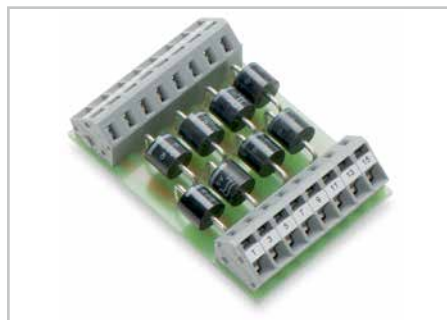

Diode module



Relay module, 16 channels

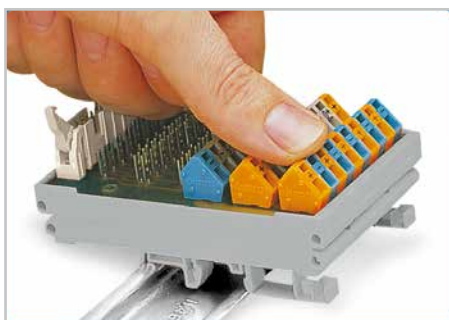

Snapping a module onto DIN-rail.

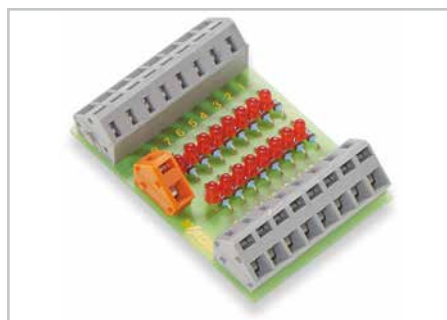

LED module



Relay module with fuse, 16 channels

WAGO System Wiring

- Overview and Application Examples -

SIEMENS S7-300			WAGO Interface Cables		WAGO Interface Modules	
			Item No.	Qty.	Type	Qty.
CPU	6ES7 313-5BE01-0AB0	16 DI/16 DO	706-2300/301-XXX	1	T16ES/T16S	1/1
	6ES7 313-5BF03-0AB0	16 DI/16 DO	706-2300/301-XXX	1	T16ES/T16S	1/1
	6ES7 313-6BE01-0AB0	16 DI/16 DO	706-2300/301-XXX	1	T16ES/T16S	1/1
	6ES7 313-6BF03-0AB0	16 DI/16 DO	706-2300/301-XXX	1	T16ES/T16S	1/1
	6ES7 313-6CE01-0AB0	16 DI/16 DO	706-2300/301-XXX	1	T16ES/T16S	1/1
	6ES7 313-6CF03-0AB0	16 DI/16 DO	706-2300/301-XXX	1	T16ES/T16S	1/1
	6ES7 314-6BF01-0AB0	16 DI/16 DO	706-2300/301-XXX	1	T16ES/T16S	1/1
	6ES7 314-6BG03-0AB0	16 DI/16 DO	706-2300/301-XXX	1	T16ES/T16S	1/1
	6ES7 314-6CF01-0AB0	16 DI/16 DO	706-2300/301-XXX	1	T16ES/T16S	1/1
6ES7 314-6CG03-0AB0	16 DI/16 DO	706-2300/301-XXX	1	T16ES/T16S	1/1	
DI	6ES7 321-1BH02-0AA0	16 DI	706-2300/300-XXX	1	T16ES	1
	6ES7 321-1BH10-0AA0	16 DI	706-2300/300-XXX	1	T16ES	1
	6ES7 321-1BH80-0AA0	16 DI	706-2300/300-XXX	1	T16ES	1
	6ES7 321-1BL00-0AA0	32 DI	706-2300/301-XXX	1	T16ES	2
	6ES7 321-1BL80-0AA0	32 DI	706-2300/301-XXX	1	T16ES	2
	6ES7 321-1BP00-0AA0	64 DI	706-2300/100-XXX	2	T16ES	4
	6ES7 321-7BH01-0AA0	16 DI	706-2300/101-XXX	1	T16ES	1
6ES7 321-7BH80-0AA0	16 DI	706-2300/101-XXX	1	T16ES	1	
DO	6ES7 322-1BH01-0AA0	16 DO	706-2300/300-XXX	1	T16ES/T16S	1
	6ES7 322-1BH10-0AA0	16 DO	706-2300/300-XXX	1	T16ES/T16S	1
	6ES7 322-1BH80-0AA0	16 DO	706-2300/300-XXX	1	T16ES/T16S	1
	6ES7 322-1BL00-0AA0	32 DO	706-2300/301-XXX	1	T16ES/T16S	2
	6ES7 322-1BP00-0AA0	64 DO	706-2300/200-XXX	2	T16ES/T16S	4
	6ES7 322-1EH01-0AA0	16 DO	706-2300/300-XXX	1	T16ES/T16S	1
	6ES7 322-8BF00-0AB0	8 DO	706-2300/201-XXX	1	T8ES/T8S	1
AI	6ES7 331-7HF01-0AB0	8 AI	706-2300/400-XXX	1	A8ES	1
	6ES7 331-7KF02-0AB0	8 AI	706-2300/400-XXX	1	A8ES	1
	6ES7 331-7NF00-0AB0	8 AI	706-2300/404-XXX	1	A8ES	1
	6ES7 331-7NF10-0AB0	8 AI	706-2300/406-XXX	1	A8ES	1
	6ES7 331-7SF00-0AB0	8 AI	706-2300/400-XXX	1	A8ES	1
	6ES7 331-7TF00-0AB0	8 AI	706-2300/400-XXX	1	A8ES	1
AO	6ES7 332-5HB01-0AB0	2 AO	706-2300/400-XXX	1	A4ES	1
	6ES7 332-5HB81-0AB0	2 AO	706-2300/400-XXX	1	A4ES	1
	6ES7 332-5HD01-0AB0	4 AO	706-2300/404-XXX	1	A4ES	1
	6ES7 332-5HF00-0AB0	8 AO	706-2300/406-XXX	1	A8ES	1
	6ES7 332-7ND02-0AB0	4 AO	706-2300/400-XXX	1	A4ES	1
	6ES7 332-8TF00-0AB0	8 AO	706-2300/400-XXX	1	A8ES	1

WAGO-I/O-SYSTEM 753			WAGO Interface Cables		WAGO Interface Modules	
	I/O Modules		Item No.	Qty.	Type	Qty.
DI	753-430 (x1)	8 DI	706-7753/300-XXX	1	T8ES	1
	753-430 (x2)	16 DI	706-7753/301-XXX	1	T16ES	1
	753-431 (x1)	8 DI	706-7753/300-XXX	1	T8ES	1
	753-431 (x2)	16 DI	706-7753/301-XXX	1	T16ES	1
DO	753-530 (x1)	8 DO	706-7753/300-XXX	1	T8ES/T8S	1
	753-530 (x2)	16 DO	706-7753/301-XXX	1	T16ES/T16S	1

For an overview of interface modules, see page 234.

WAGO-I/O-SYSTEM 750			WAGO Interface Cables		WAGO Interface Modules	
	I/O Modules		Item No.	Qty.	Type	Qty.
DI	750-1400	16 DI	706-3057/300-XXX	1	T16ES	1
DO	750-1500	16 DO	706-3057/300-XXX	1	T16ES	1
DI/DO	750-1502	8 DI/8 DO	706-7753/302-XXX	1	T8ES/T8S	1/1
	750-1502	8 DI/8 DO	706-3057/300-XXX	1	T16ES	1

For an overview of interface modules, see page 234.

WAGO Interface Modules				
	Type	Short Description	Dimensions (mm) W x H x D	Item No.
DI/DO	T8ES	10-pole, without supply	35 x 48 x 85	289-611
		10-pole, with LEDs, 3 conductors	56 x 63 x 85	704-2003
	T8S	10-pole, with LEDs, 5 A relay	70 x 65 x 105	704-5003
		10-pole, with LEDs, 5 A relay, manual operation	75 x 65 x 105	704-5013
	T16ES	20-pole, without supply	47 x 62 x 85	289-614
		20-pole, with LEDs, 1 conductor	55 x 50 x 85	704-2004
		20-pole, with LEDs, 2 conductors	85 x 50 x 85	704-2024
		20-pole, with LEDs, 2 conductors, disconnection	99 x 50 x 85	704-2044
		20-pole, with LEDs, 3 conductors	85 x 63 x 85	704-2054
		20-pole, with LEDs, 5 A relay	180 x 50 x 105	704-5004
	T16S	20-pole, with LEDs, relay socket without relay	180 x 50 x 105	704-5014
		20-pole, with LEDs, 5 A relay	111 x 65 x 105	704-5024
		20-pole, with LEDs, 5 A relay, fuse	247 x 55 x 105	704-5034
		20-pole, with LEDs, 5 A relay, manual operation	121 x 65 x 105	704-5044
20-pole, with LEDs, 5 A relay, disconnection, fuse		240 x 55 x 105	704-5054	
20-pole, with LEDs, 5 A (2 u) relay		247 x 50 x 105	704-5064	
20-pole, with LEDs, 5 A (1 a) relay, disconnection, fuse		240 x 55 x 105	704-5074	
AI/AO		A4ES	15-pole D-sub, 2/4 conductors, disconnection	66 x 50 x 105
	A8ES	25-pole D-sub, 2/4 conductors, disconnection	92 x 50 x 105	704-8013

WAGO Interface Cables				
	Type	Item No.		
DI/DO	WAGO-753 T8ES	706-7753/300-XXX	See www.wago.com	
	WAGO-753 T16ES	706-7753/301-XXX	See www.wago.com	
	WAGO-750 HE T8E8S	706-7753/302-XXX		
	TSX T16ES	706-3057/300-XXX		
	S7-300 T16E	706-2300/101-XXX		
	S7-300 2 x T16E	706-2300/100-XXX		
	S7-300 T8S	706-2300/201-XXX		
	S7-300 2 x T16S	706-2300/200-XXX		
	S7-300 T16ES	706-2300/300-XXX		
	S7-300 2 x T16ES	706-2300/301-XXX		
AI/AO	S7-300 A8E	706-2300/400-XXX		
	S7-300 A8E11	706-2300/404-XXX		
	S7-300 A8E12	706-2300/406-XXX		
	S7-300 A4SI	706-2300/500-XXX		
	S7-300 A8SI	706-2300/502-XXX		

Cable Length Overview				
Item No.	-XXX	Length	Example	
706-2300/201-XXX	-100	1 m	706-2300/201-100	
	-200	2 m	706-2300/201-200	
	-300	3 m	706-2300/201-300	

System cables upon request:

- SCHNEIDER M340
- SCHNEIDER QUANTUM
- SCHNEIDER TSX 37 (Micro)
- SCHNEIDER TSX 57 (Premium)
- GEFANUC 90-30 / ALSPA 80-35
- ROCKWELL COMPACT LOGIX (1769)
- ROCKWELL CONTROL LOGIX (1756)



DIN-Rail-Mount Potential Multiplication Modules, Interface Modules

288/289 Series



DIN-rail-mount potential multiplication modules	Interface modules Terminal strips with CAGE CLAMP® (236 Series) Mounting carrier for DIN-35 rail 0.08 ... 2.5 mm ² 28 ... 12 AWG 5 ... 6 mm / 0.22 in.	Interface modules Terminal strips with CAGE CLAMP® (736/737 Series) Mounting carrier for DIN-35 rail 0.08 ... 2.5 mm ² 28 ... 12 AWG 5 ... 6 mm / 0.22 in.
--	--	--

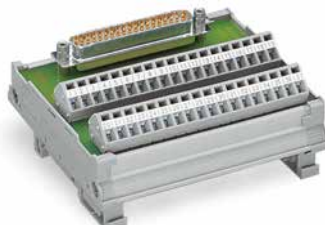
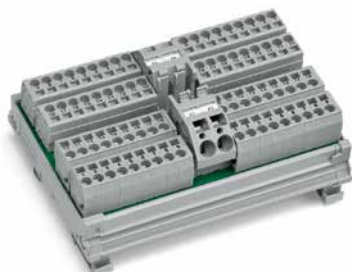

Item No.	Pack. Unit		Item No.	Pack. Unit		Item No.	Pack. Unit	
		Potential multiplication module, 4 potentials, each with 18 connection points 288-825 1 250 VAC/DC / 12 A			Interface modules with D-subminiature male connector, for mating connectors with solder connection 9-pole 289-545 1 15-pole 289-546 1 25-pole 289-547 1 37-pole 289-548 1 50-pole 289-549 1 for mating connectors with IDC 9-pole 289-540 1 15-pole 289-541 1 25-pole 289-542 1 37-pole 289-543 1 50-pole 289-544 1			Interface modules with male connector per DIN 41651 and multilevel PCB terminal strip 10-pole 289-611 1 14-pole 289-612 1 16-pole 289-613 1 20-pole 289-614 1 26-pole 289-615 1 34-pole 289-616 1 40-pole 289-617 1 50-pole 289-618 1 64-pole 289-619 1
		Potential multiplication module, 4 potentials, each with one supply and 18 connection points 288-837 1 250 VAC/DC / 12 A			Interface modules with D-subminiature female connector, for mating connectors with solder connection 9-pole 289-555 1 15-pole 289-556 1 25-pole 289-557 1 37-pole 289-558 1 50-pole 289-559 1 for mating connectors with IDC 9-pole 289-550 1 15-pole 289-551 1 25-pole 289-552 1 37-pole 289-553 1 50-pole 289-554 1			Interface modules with male connector per DIN 41651 and single-deck PCB terminal strips 10-pole 289-501 1 14-pole 289-502 1 16-pole 289-503 1 20-pole 289-504 1 26-pole 289-505 1 34-pole 289-506 1 40-pole 289-507 1 50-pole 289-508 1 64-pole 289-509 1
		Potential multiplication module, 4 potential groups, each with 6 connection points for positive and negative potentials 288-867 1 24 VDC / 10 A			Interface modules with D-subminiature male connector for mating connectors with solder connection 9-pole 289-720 1 15-pole 289-721 1 25-pole 289-722 1 37-pole 289-723 1			Also available for connectors complying with: DIN 41612 (types E, F) and DIN 41651 RJ-45 interface modules Cat. 5 RJ to 4-pole + S 289-174 RJ to 4-pole + S + P 289-178 RJ to 8-pole + S 289-175 RJ to 8-pole + S + P 289-179 RJ + S to RJ + S 289-172 RJ + S + P to RJ + S + P 289-176 RJ + S + P x RJ + S + P 289-177 RJ-45 interface module Cat. 6 RJ to 8-pole + S 289-195
		Potential multiplication module, 4 potentials, each with 24 VDC with 5 connection points of 24 V and 5 connection points of 0 V 288-870/000-030 1 24 VDC / 10 A			Interface modules with D-subminiature female connector for mating connectors with IDC 9-pole 289-725 1 15-pole 289-726 1 25-pole 289-727 1 37-pole 289-728 1			
		Potential multiplication module, 8 potentials, each with 24 VDC with 5 connection points of 24 V and 5 connection points of 0 V 288-870/000-040 1 24 VDC / 10 A						

Please find the entire product range in our Full Line Catalog. For additional information, visit www.wago.com.

S: Shield; P: Power jumper contacts

DIN-Rail-Mount PCB Carriers

288 Series

Mounting carrier, size 1, 85 mm wide, for DIN-rail mounting of 71.2 mm wide PCBs

Mounting carrier, size 2, 106 mm wide, for DIN-rail mounting of 100 mm wide PCBs



Mounting Carrier, Size 1, Low-Profile

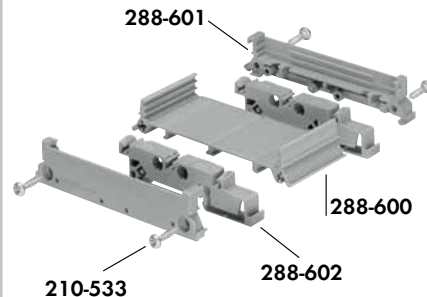

Mounting Carrier, Size 2, Low-Profile

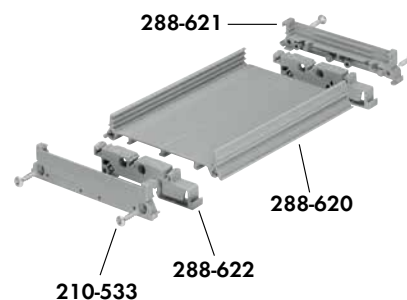

Mounting Carrier, Size 2, High-Profile, with Cover



Item No.	Pack. Unit	Item No.	Pack. Unit
Lateral cover, size 1, low-profile, 6.35 mm thick	288-601 1	Lateral cover, size 2, low-profile, 8.75 mm thick	288-621 1
Mounting foot for DIN-35 rail	288-602 1	Mounting foot for DIN-35 rail	288-622 1
Carrier base, size 2, 1 m long	288-600 1	Carrier base, size 2, 1 m long	288-620 1
		Lateral cover, size 2, high-profile, 8.75 mm thick	288-626 1
		Cover, size 2, 1 mm long	288-627 1
Phillips screw, 2.9 x 13	210-533 25	Phillips screw, 2.9 x 13	210-533 25
2 pcs per lateral cover; for a module length of 39 mm or higher; lateral covers must be riveted for smaller modules.		2 pcs per lateral cover; for a module length of 39 mm or higher; lateral covers must be riveted for smaller modules.	
Rivet length depends on module length; rivets are not offered by WAGO.		Rivet length depends on module length; rivets are not offered by WAGO.	

Accessories, 288 Series

PCB length: L1
 Base length: L2 = L1 - 11 mm
 Mounting carrier length: L3 = L1 + 2 mm
 Lateral cover, type 1: 6.35 mm thick
 Free space between profile and PCB: 5 mm (when using upper groove)

PCB length: L1
 Base length: L2 = L1 - 15.8 mm
 Mounting carrier length: L3 = L1 + 2 mm
 Cover length: L4 = L1
 Lateral cover, size 2: 8.75 mm thick
 Free space between profile and PCB: 5 mm

Mounting Carrier, Size 1, Low-Profile

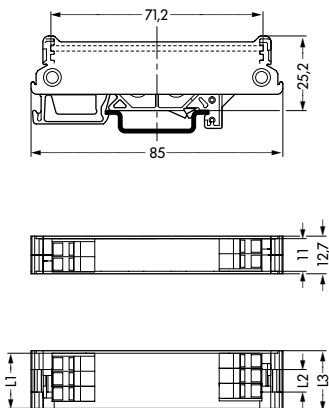

Mounting Carrier, Size 2, Low-Profile

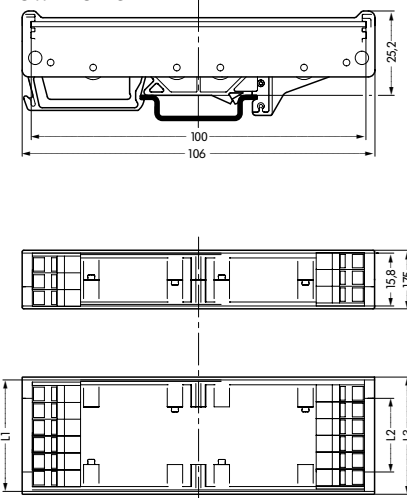

Mounting Carrier, Size 2, High-Profile

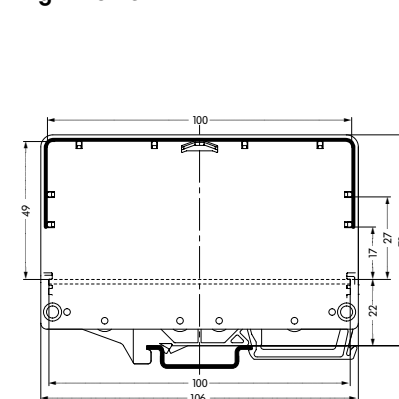

For technical explanations and abbreviations, see technical section.

Empty Component Plug Housings for Building Custom Circuits

280/286/2002 Series

Plug width: 5.2 mm/0.205 in. 10.4 mm/0.409 in.	Plug width: 5 mm/0.197 in. 10 mm/0.394 in. 250 V/4 kV/3 6 A (max.)	Plug width: 10 mm/0.394 in. 15 mm/0.591 in. 20 mm/0.787 in. 25 mm/0.984 in. 250 V/4 kV/3 6 A (max.)
--	--	---



Type 1





































2

Type 6 5 4 3

Type 10 9 8 7

Type	Item No.	Pack. Unit	Type	Item No.	Pack. Unit	Type	Item No.	Pack. Unit
Empty component plugs for carrier terminal blocks, 2002 Series			Empty component plugs for carrier terminal blocks			Empty component plug housings for terminal blocks for pluggable modules		
Type 1	2002-800	100	Type 3	280-801	100	Type 7	286-110	1
2-pole, 5.2 mm/0.205 in. wide			2-pole, 5 mm/0.197 in. wide, Plug inside dimensions: W/H/D (3.2/15/15) mm			4-pole, 10 mm/0.394 in. wide		
Type 1	2002-810	50	Type 4	280-802	50	Type 8	286-111	1
2-pole, 10.4 mm/0.409 in. wide			2-pole, 10 mm/0.394 in. wide, Plug inside dimensions: W/H/D (8.2/15/15) mm			6-pole, 15 mm/0.591 in. wide		
Type 1	2002-820	50	Type 5	280-804	50	Type 9	286-112	1
4-pole, 10.4 mm/0.409 in. wide			4-pole, 10 mm/0.394 in. wide, Plug inside dimensions: W/H/D (8.2/15/15) mm			8-pole, 20 mm/0.787 in. wide		
Empty component plug for through terminal blocks, 2001, 2002, 2004 and 2006 Series			Empty component plug for through terminal blocks			Type 10		
Type 2	2002-880	50	Type 6	280-803	50	286-113		
2-pole, 10.4 mm/0.409 in. wide			2-pole, 10 mm/0.394 in. wide, Plug inside dimensions: W/H/D (8.2/15/15) mm			10-pole, 25 mm/0.984 in. wide		

Accessories, 280, 286 and 2002 Series

2-cond. carrier terminal block, 5.2 mm wide  0.25 ... 2.5 (4) mm ² /22 ... 12 AWG  10 ... 12 mm / 0.43 in. gray 2002-1661 50	2-cond. carrier terminal block, 5 mm wide  0.08 ... 2.5 mm ² /28 ... 14 AWG  8 ... 9 mm / 0.33 in. gray 280-916 100	Terminal blocks for pluggable modules, with 2-cond. blocks, polarized, with orange separator  0.08 ... 2.5 mm ² /28 ... 14 AWG  8 ... 9 mm / 0.33 in.
4-cond. carrier terminal block, 5.2 mm wide  0.25 ... 2.5 (4) mm ² /22 ... 12 AWG  10 ... 12 mm / 0.43 in. gray 2002-1861 50	3-cond. carrier terminal block, 5 mm wide  0.08 ... 2.5 mm ² /28 ... 14 AWG  8 ... 9 mm / 0.33 in. gray 280-610 100	4-pole, 12 mm/0.472 in. wide 280-618 1 6-pole, 17 mm/0.669 in. wide 280-619 1 8-pole, 22 mm/0.866 in. wide 280-638 1 10-pole, 27 mm/1.063 in. wide 280-639 1
2-cond. through terminal block, 5.2 mm wide  0.25 ... 2.5 (4) mm ² /22 ... 12 AWG  10 ... 12 mm / 0.43 in. gray 2002-1201 100	4-cond. carrier terminal block, 5 mm wide  0.08 ... 2.5 mm ² /28 ... 14 AWG  8 ... 9 mm / 0.33 in. gray 280-686 100	Terminal blocks for pluggable modules, with 4-cond. blocks, polarized, with orange separator  0.08 ... 2.5 mm ² /28 ... 14 AWG  8 ... 9 mm / 0.33 in.
3-cond. through terminal block, 5.2 mm wide  0.25 ... 2.5 (4) mm ² /22 ... 12 AWG  10 ... 12 mm / 0.43 in. gray 2002-1301 100	2-cond. through terminal block, 5 mm wide  0.08 ... 2.5 mm ² /28 ... 14 AWG  8 ... 9 mm / 0.33 in. gray 280-901 100	4-pole, 12 mm/0.472 in. wide 280-608 1 6-pole, 17 mm/0.669 in. wide 280-609 1 8-pole, 22 mm/0.866 in. wide 280-628 1 10-pole, 27 mm/1.063 in. wide 280-629 1
4-cond. through terminal block, 5.2 mm wide  0.25 ... 2.5 (4) mm ² /22 ... 12 AWG  10 ... 12 mm / 0.43 in. gray 2002-1401 100	3-cond. through terminal block, 5 mm wide  0.08 ... 2.5 mm ² /28 ... 14 AWG  8 ... 9 mm / 0.33 in. gray 280-681 100	1-cond./1-cond. terminal blocks for pluggable modules, with orange separator  0.08 ... 4 mm ² /28 ... 12 AWG  8 ... 9 mm / 0.33 in.
2-cond. through terminal block, 6.2 mm wide  0.5 ... 4 (6) mm ² /20 ... 10 AWG  11 ... 13 mm / 0.47 in. gray 2004-1201 50	4-cond. through terminal block, 5 mm wide  0.08 ... 2.5 mm ² /28 ... 14 AWG  8 ... 9 mm / 0.33 in. gray 280-833 100	4-pole, 11.1 mm/0.437 in. wide 769-192/769-319 10 6-pole, 16.1 mm/0.634 in. wide 769-193/769-319 5 8-pole, 21.1 mm/0.831 in. wide 769-194/769-319 5 10-pole, 26.1 mm/1.028 in. wide 769-195/769-319 5
2-cond. through terminal block, 7.5 mm wide  0.5 ... 6 (10) mm ² /20 ... 8 AWG  13 ... 15 mm / 0.55 in. gray 2006-1201 50	2-cond. through terminal block, 5 mm wide side-entry wiring,  0.08 ... 2.5 mm ² /28 ... 14 AWG  8 ... 9 mm / 0.33 in. gray 280-101 100	Unlocking pliers, for removing empty component plug housing covers 
Multi-purpose operating tool, for component plugs  2002-116 5		210-492 1

Please find the entire product range in our Full Line Catalog. For additional information, visit www.wago.com.

Modular Empty Housings

2857 Series

- Overview and Configuration -

Supplied as a pre-assembled unit

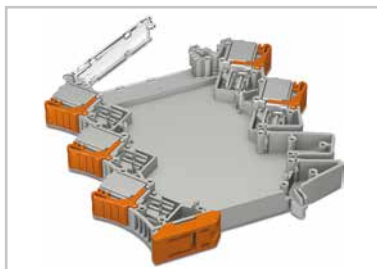

1. Pre-assembled unit



2. Inserting and soldering the PCB

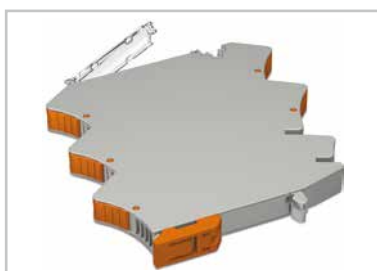

3. Snapping on side wall

Pluggable **picoMAX®** connections





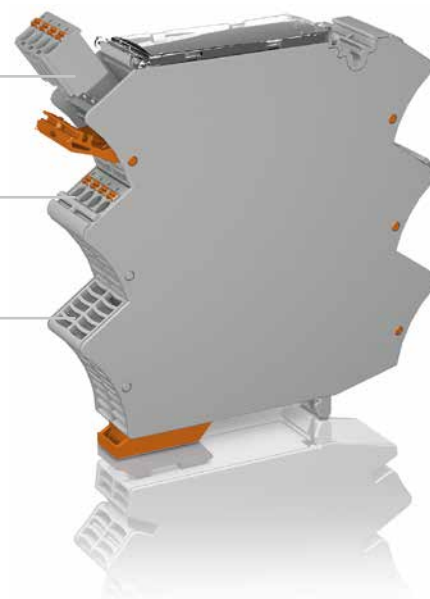

Fixed **picoMAX®** connections

Empty slot

... freely selectable for each connection point



Housing configuration:

Housing width: 12.5 mm/0.49 in.	 2857-101	 2857-102	 2857-103	-
Housing width: 22.5 mm/0.89 in.	 2857-121	 2857-122	 2857-123	 2857-124
Connection levels	2-2	3-2	3-3	1-1
Jumper slots	2-2	0-2	0-0	2-2

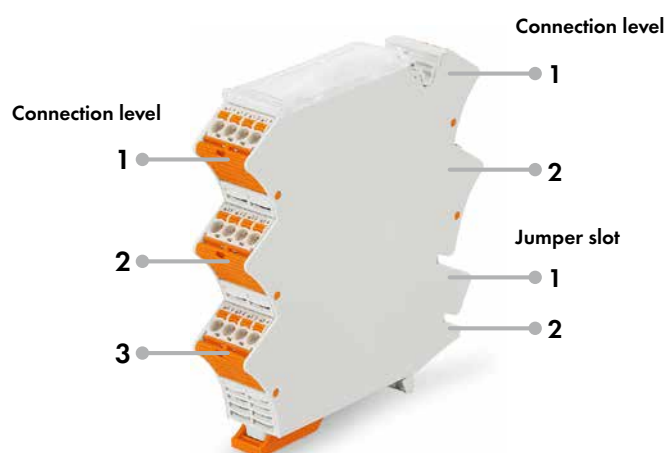

Mixed configuration (fixed/removable/empty slot) upon request.

Example of connection level and jumper slot assignment:

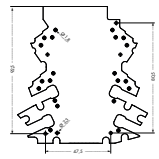
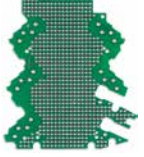
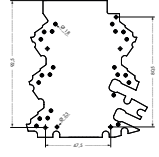
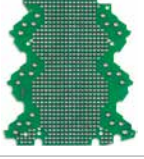
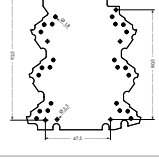

Connection levels	3-2
Jumper slots	0-2

Stripboards for installation in 12.5 mm and 22.5 mm empty housings:

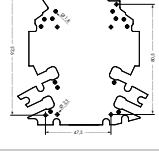
		2-2 connection levels, 2-2 jumper slots 2857-191/3140-000
		3-2 connection levels, 0-2 jumper slots 2857-192/3140-000
		3-3 connection levels, 0-0 jumper slots 2857-193/3140-000
		1-1 connection levels, 2-2 jumper slots 2857-194/3140-000

Smart Data Engineering

Supports Workflow from Control Cabinet Planning to Installation

Electrical Engineering

Directly import data from the CAE circuit diagram into the **smartDESIGNER** engineering software

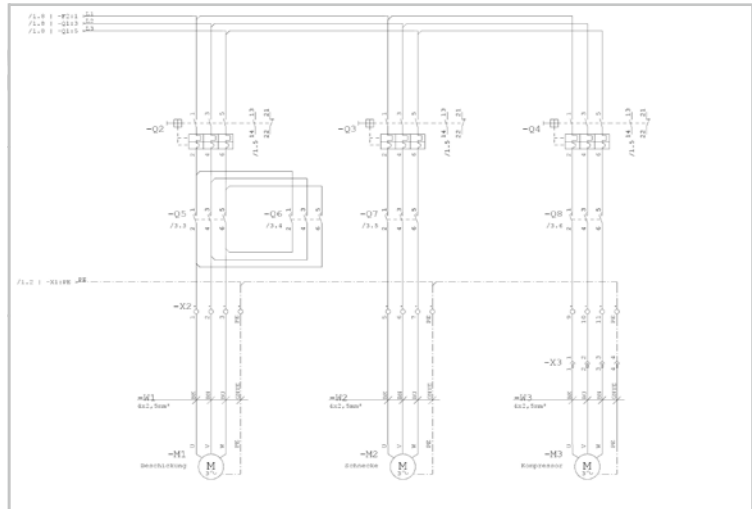

CLASSIFICATION AND PRODUCT DESCRIPTION

- 27 Elektr., Automaten- und Präzisionsbau
- 27-01 unterteilt
- 27-02 Schaltkasten-Modul
- 27-03 Transformator, Wandl., Drossel
- 27-04 Stromversorgungsgeräte
- 27-05 Lichtanlage, Leuchte
- 27-06 Motor- und Antrieb
- 27-07 Mess-, Prüf-, und Meßtechnik
- 27-08 Mess-, Prüf-, und Meßtechnik
- 27-09 Mess-, Prüf-, und Meßtechnik
- 27-10 Mess-, Prüf-, und Meßtechnik
- 27-11 Mess-, Prüf-, und Meßtechnik
- 27-12 Mess-, Prüf-, und Meßtechnik
- 27-13 Mess-, Prüf-, und Meßtechnik
- 27-14 Mess-, Prüf-, und Meßtechnik
- 27-15 Mess-, Prüf-, und Meßtechnik
- 27-16 Mess-, Prüf-, und Meßtechnik
- 27-17 Mess-, Prüf-, und Meßtechnik
- 27-18 Mess-, Prüf-, und Meßtechnik
- 27-19 Mess-, Prüf-, und Meßtechnik
- 27-20 Mess-, Prüf-, und Meßtechnik
- 27-21 Mess-, Prüf-, und Meßtechnik
- 27-22 Mess-, Prüf-, und Meßtechnik
- 27-23 Mess-, Prüf-, und Meßtechnik
- 27-24 Mess-, Prüf-, und Meßtechnik
- 27-25 Mess-, Prüf-, und Meßtechnik
- 27-26 Mess-, Prüf-, und Meßtechnik
- 27-27 Mess-, Prüf-, und Meßtechnik
- 27-28 Mess-, Prüf-, und Meßtechnik
- 27-29 Mess-, Prüf-, und Meßtechnik
- 27-30 Mess-, Prüf-, und Meßtechnik
- 27-31 Mess-, Prüf-, und Meßtechnik
- 27-32 Mess-, Prüf-, und Meßtechnik
- 27-33 Mess-, Prüf-, und Meßtechnik
- 27-34 Mess-, Prüf-, und Meßtechnik
- 27-35 Mess-, Prüf-, und Meßtechnik
- 27-36 Mess-, Prüf-, und Meßtechnik
- 27-37 Mess-, Prüf-, und Meßtechnik
- 27-38 Mess-, Prüf-, und Meßtechnik
- 27-39 Mess-, Prüf-, und Meßtechnik
- 27-40 Mess-, Prüf-, und Meßtechnik
- 27-41 Mess-, Prüf-, und Meßtechnik
- 27-42 Mess-, Prüf-, und Meßtechnik
- 27-43 Mess-, Prüf-, und Meßtechnik
- 27-44 Mess-, Prüf-, und Meßtechnik
- 27-45 Mess-, Prüf-, und Meßtechnik
- 27-46 Mess-, Prüf-, und Meßtechnik
- 27-47 Mess-, Prüf-, und Meßtechnik
- 27-48 Mess-, Prüf-, und Meßtechnik
- 27-49 Mess-, Prüf-, und Meßtechnik
- 27-50 Mess-, Prüf-, und Meßtechnik
- 27-51 Mess-, Prüf-, und Meßtechnik
- 27-52 Mess-, Prüf-, und Meßtechnik
- 27-53 Mess-, Prüf-, und Meßtechnik
- 27-54 Mess-, Prüf-, und Meßtechnik
- 27-55 Mess-, Prüf-, und Meßtechnik
- 27-56 Mess-, Prüf-, und Meßtechnik
- 27-57 Mess-, Prüf-, und Meßtechnik
- 27-58 Mess-, Prüf-, und Meßtechnik
- 27-59 Mess-, Prüf-, und Meßtechnik
- 27-60 Mess-, Prüf-, und Meßtechnik
- 27-61 Mess-, Prüf-, und Meßtechnik
- 27-62 Mess-, Prüf-, und Meßtechnik
- 27-63 Mess-, Prüf-, und Meßtechnik
- 27-64 Mess-, Prüf-, und Meßtechnik
- 27-65 Mess-, Prüf-, und Meßtechnik
- 27-66 Mess-, Prüf-, und Meßtechnik
- 27-67 Mess-, Prüf-, und Meßtechnik
- 27-68 Mess-, Prüf-, und Meßtechnik
- 27-69 Mess-, Prüf-, und Meßtechnik
- 27-70 Mess-, Prüf-, und Meßtechnik
- 27-71 Mess-, Prüf-, und Meßtechnik
- 27-72 Mess-, Prüf-, und Meßtechnik
- 27-73 Mess-, Prüf-, und Meßtechnik
- 27-74 Mess-, Prüf-, und Meßtechnik
- 27-75 Mess-, Prüf-, und Meßtechnik
- 27-76 Mess-, Prüf-, und Meßtechnik
- 27-77 Mess-, Prüf-, und Meßtechnik
- 27-78 Mess-, Prüf-, und Meßtechnik
- 27-79 Mess-, Prüf-, und Meßtechnik
- 27-80 Mess-, Prüf-, und Meßtechnik
- 27-81 Mess-, Prüf-, und Meßtechnik
- 27-82 Mess-, Prüf-, und Meßtechnik
- 27-83 Mess-, Prüf-, und Meßtechnik
- 27-84 Mess-, Prüf-, und Meßtechnik
- 27-85 Mess-, Prüf-, und Meßtechnik
- 27-86 Mess-, Prüf-, und Meßtechnik
- 27-87 Mess-, Prüf-, und Meßtechnik
- 27-88 Mess-, Prüf-, und Meßtechnik
- 27-89 Mess-, Prüf-, und Meßtechnik
- 27-90 Mess-, Prüf-, und Meßtechnik
- 27-91 Mess-, Prüf-, und Meßtechnik
- 27-92 Mess-, Prüf-, und Meßtechnik
- 27-93 Mess-, Prüf-, und Meßtechnik
- 27-94 Mess-, Prüf-, und Meßtechnik
- 27-95 Mess-, Prüf-, und Meßtechnik
- 27-96 Mess-, Prüf-, und Meßtechnik
- 27-97 Mess-, Prüf-, und Meßtechnik
- 27-98 Mess-, Prüf-, und Meßtechnik
- 27-99 Mess-, Prüf-, und Meßtechnik
- 27-100 Mess-, Prüf-, und Meßtechnik

Technical and Commercial Item Data:
Classified by ETIM and ecl@ss – also in Advanced Format

Mechanical Engineering

CAD export into all standard CAD formats and in different granularities

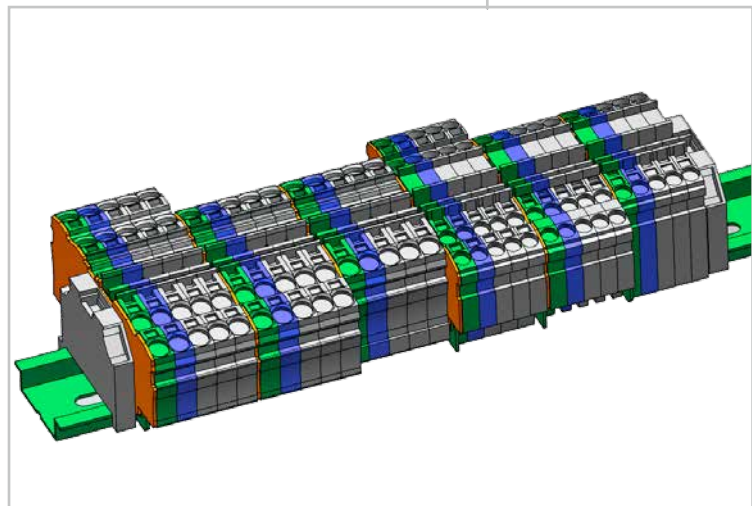

smartDESIGNER

- Free online configuration and ordering software for all electrical interconnect and automation components
- No installation
- Available worldwide 24 hours a day
- Current item data
- Edit via WAGO expert knowledge
- Design in full 3D

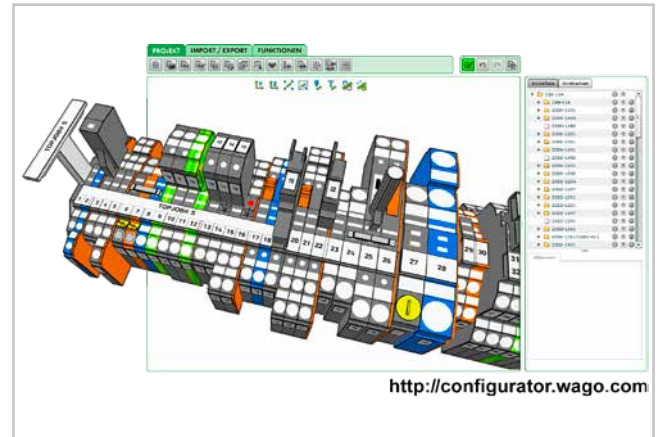
**smartSCRIPT**

- XML-based software for all WAGO marking materials
- Data import from CAE systems
- Font size check
- Material selection wizard



Configuration made easy – <http://configurator.wago.com>

Smart Data Engineering

Fast and Easy Control Cabinet Marking

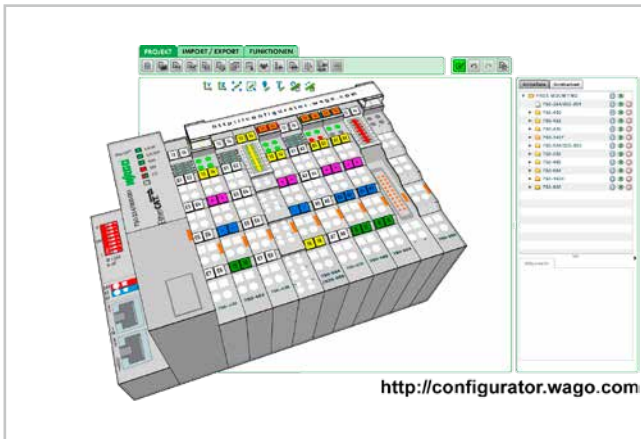

smartDESIGNER

After designing, print labeling materials directly out of the project via **smartPRINTER**

smartPRINTER

Thermal transfer printer quickly and easily labels the entire control cabinet:

- WAGO marking strips and markers
- Type plates
- Push-button markers
- Labels
- Cable and wire markers

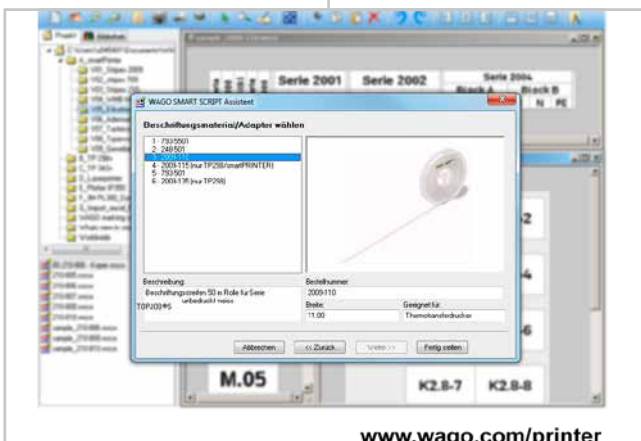

smartSCRIPT

- Import from CAE systems or create customized marking
- Print directly on **smartPRINTER**

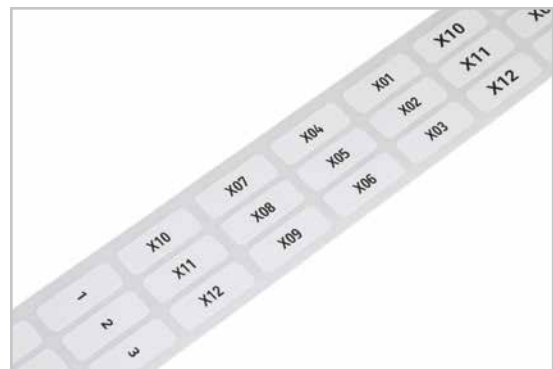
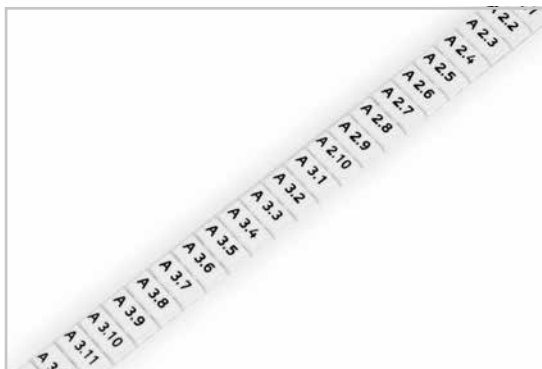
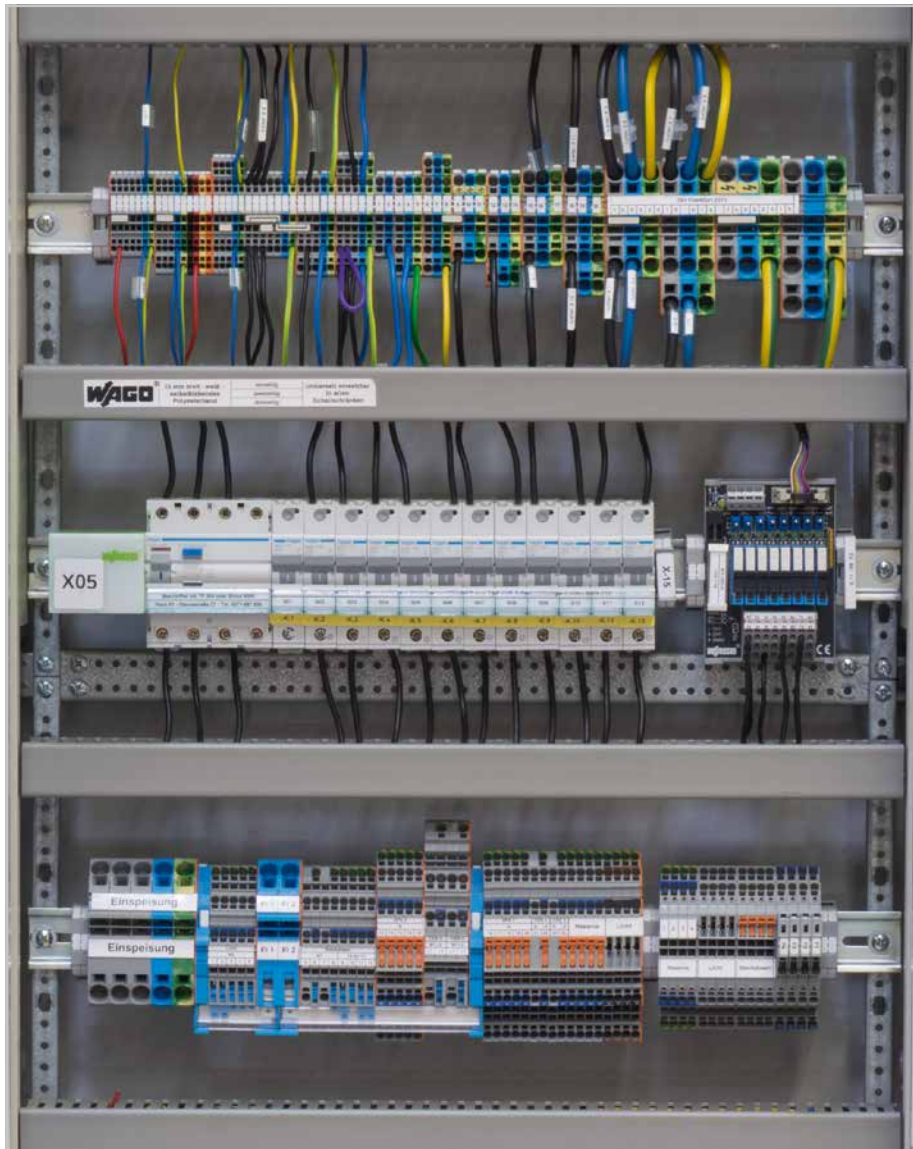
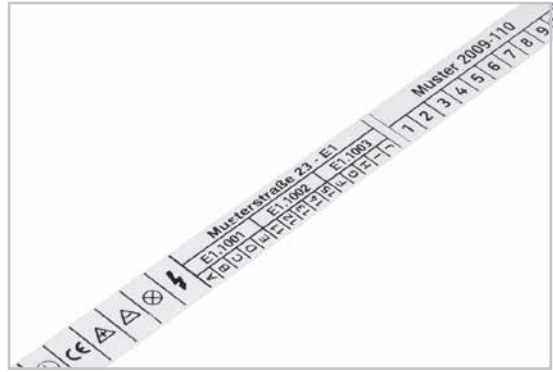

For more information, visit www.wago.com/smartprinter

smartPRINTER - Installation -



Printer upon delivery



Accessories for material unwinding



Open the printer.



Insert the ink ribbon.



Prepare the marking material.



Printing 2009-110 **markingSTRIP** on TOPJOB® S Terminal Blocks via **smartPRINTER**.



Insert and secure the suitable roller into the printer.



Printer has several interfaces:
USB, ETHERNET, serial COM port



Fast, cost-effective and easy to use - printing WMB Inline markers via **smartPRINTER**

Also visit www.wago.com/smartprinter

Thermal Transfer Printer, Plotter, Engraver 258 Series

smartPRINTER 300 dpi resolution Dimensions (W x H x D): 135 x 175 x 245 mm	IP 200 Plotter, including software Dimensions (W x H x D): 125 x 660 x 440 mm	EG 450 Engraver Dimensions (W x H x D): 240 x 290 x 315 mm (control unit + vacuum cleaner on top of each other)
---	--	--



Description	Item No.	Description	Item No.	Description	Item No.
smartPRINTER	258-5000	IP 200 Plotter, A4	258-200	EG 450 Engraver	258-450
includes power supply unit and cable, USB cable, 1 x marking strip roll and WMB Inline markers, 2 x roller, 1 x roll holder, 1 x ink ribbon, smartSCRIPT marking software and driver		Maximum plot area	440 x 305 mm (A3) 220 x 305 mm (A4)	Technical data (engraving spindle):	
Printing method	Thermal transfer	Interfaces	Parallel Centronics (LPT), USB 1.1	Rotational speed	min. 5000 rpm, max. 50000 rpm
Print head	Glass layer, spring-mounted	Control language	Based on HP-GL 7475A	Torque	6 Ncm
Print resolution	300 dpi	Data buffer	16 MB	Frequency	83 ... 830 Hz
Print speed	127 mm/s (max.) (recommended: 50.8 mm/s)	Speed	400 mm/s (max.)	Power consumption	60 W (max.)
Print width	47 mm (max.)	Drive system	Two-phase stepper motor	Collets	Shaft diameter: 3 mm
Print length	762 mm (max.)	Pen storage unit	Max. 4 pens (optimum seal)	Clamping mechanism	Head clamping
Operating display	Color TFT-LCD with navigation button	Plotter pen	Special plotter pens with HP receptacle	Run-out with collet	0.03 mm
Memory	8 MB Flash, 16 MB SDRAM	Addressable resolution	0.01 mm	Housing	Aluminum
Interfaces	ETHERNET 10/100, USB, RS-232	Repeat accuracy	0.05 mm	Clamping diameter	25 mm
Sensors	Transmissive/reflective sensor (centrally mounted)	Power supply	Via separate desktop power supply unit, equipped with exchangeable supply line	Ball bearing type	Steel, lifetime lubricated, 2-times
Operating voltage	100 ... 240 VAC 50 ... 60 Hz	Operating voltage	120 ... 240 VAC, 50 ... 60 Hz	Cooling	Automatic via built-in fan
Dimensions (W x H x D)	135 x 175 x 245 mm	Voltage range	90 ... 264 VAC	Application area	Engraving only
Weight	2,000 g (without printing material)	Current consumption (internal)	0.3 A (max.) at 220 VAC	Guaranteed bearing operation	Min. 1,000 hours if used properly
Operating temperature	5 °C ... 40 °C (41 °F ... 104 °F)	Weight	approx. 8,000 g	Technical data (VEB 500 Control Unit)	
Storage temperature	-20 °C ... 50 °C (-4 °F ... 122 °F)	WAGO disposable plotter pen		Operating voltage	100 ... 240 VAC / 50 ... 60 Hz
Safety approvals	CE (EMC)	0.18 mm line width	258-326	Weight	Engraving spindle + control unit + vacuum cleaner + accessories: 8,000 g
Ink ribbon	Reel diameter: 40 mm; Internal core diameter: 0.5" (12.7 mm); Length (max.): 110 m; Width (max.): 58 mm	0.25 mm line width	258-327	Engraver set (sizes: 0.2/0.3/0.4/0.5/ 0.7/1 mm) 258-452	
Ink ribbon for smartPRINTER	258-5005	0.35 mm line width	258-328	Engraver	
Roller for markingSTRIP	258-5006	Carrier plate for:		Engraver size: 0.2 mm	258-452/000-002
Roller for WMB Inline	258-5007	WSB 5 mm	258-361	Engraver size: 0.3 mm	258-452/000-003
Roller for Miniature WSB Inline	258-5008	WSB 4 mm	258-362	Engraver size: 0.4 mm	258-452/000-004
Roller for Phoenix products	258-5009	Miniature WSB	258-363	Engraver size: 0.5 mm	258-452/000-005
Roller for Weidmüller products	258-5010	Group marker carrier (209-112)	258-364	Engraver size: 0.7 mm	258-452/000-007
Carrying case for smartPRINTER	258-5015	WMB (3.5 mm/4 mm/5 mm)	258-368	Engraver size: 1 mm	258-452/000-010
Light gray, with foam padding for printer		Marker tags (210-199/200)	258-369	Engraver (stainless steel)	
Dimensions (W x H x D): 50 x 26 x 33 cm		WAGO marker cards (210-110/120)	258-370	Engraver size: 0.2 mm	258-458/000-002
		Other receptacles available upon request		Engraver size: 0.4 mm	258-458/000-004
		Software for Printer and Plotter		Vacuum cleaner bag (type Y98) 258-457	
		WAGO smartDESIGNER		Engraver carrier plates	
		WAGO smartSCRIPT		90 mm x 100 mm x 3	258-454
		VarioSign		60 mm x 100 mm x 4	258-455
				30 mm x 100 mm x 9	258-456
For additional information, visit www.wago.com/smartprinter		Visit www.wago.com/printer		DIN A4	258-383

Marker Cards

WMB Multi Marking System

793 / 794 / 248 Series

WAGO WMB Multi Marking System for terminal blocks featuring Miniature WSB and WSB marker slots, 10 strips with 10 markers for each card, 5 cards per packing unit	WAGO WMB Multi Marking System for terminal blocks featuring Miniature WSB and WSB marker slots, 10 strips with 10 markers for each card, 5 cards per packing unit	WAGO WMB Multi Marking System and WAGO Miniature WSB Quick Marking System 10 strips with 10 markers for each card, 5 cards per packing unit
--	--	--

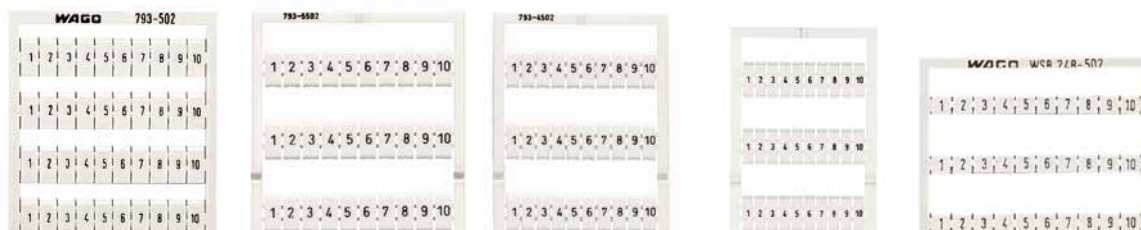

Marking	Item No.	Item No.	Item No.	Item No.	Item No.
		WMB Multi Marking System			Miniature WSB
		for terminal block width:			for 264, 750, 769 Series
	5 mm	5 ... 5.2 mm	4 ... 4.2 mm	3.5 mm	
		stretchable	stretchable		
plain	793-501	793-5501	793-4501	793-3501	248-501
1 ... 10 (10x)	793-502	793-5502	793-4502	793-3502	248-502
11 ... 20 (10x)	793-503	793-5503	793-4503	793-3503	248-503
21 ... 30 (10x)	793-504	793-5504	793-4504	793-3504	248-504
31 ... 40 (10x)	793-505	793-5505	793-4505	793-3505	248-505
41 ... 50 (10x)	793-506	793-5506	793-4506	793-3506	248-506
1 ... 9 (10x)	793-565	793-5565	793-4565	793-3565	248-565
1 ... 50 (2x)	793-566	793-5566	793-4566	793-3566	248-566
51 ... 100 (2x)	793-507	793-5507	793-4507	793-3507	248-507
101 ... 150 (2x)	793-508	793-5508	793-4508	793-3508	248-508
151 ... 200 (2x)	793-509	793-5509	793-4509	793-3509	248-509
R, S, T, U, V, W, X, Y, Z, MP	793-544	793-5544	793-4544	793-3544	248-544
A, B, P, N, PE, PEN, L1, L2, L3, ⊕	793-545	793-5545	793-4545	793-3545	248-545
(in strips with 10 identical letters)					
for double-deck terminal blocks					All listed markings are also available on colored marker cards (black printing).
1, 3, 5, ..., 99 and 2, 4, 6, ..., 100 (1x)	793-599	793-5599	793-4599		Item no. suffixes for colored marker cards:
for triple-deck terminal blocks					● ... /000-002
1, 4, 7, ..., 88 and 2, 5, 8, ..., 89 and 3, 6, 9, ..., 90 and 91, 94, 97, ..., 99 (1x)	794-557	794-5557	-		● ... /000-005
					● ... /000-006
					● ... /000-007
					● ... /000-012
					● ... /000-017
					● ... /000-023
					● ... /000-024

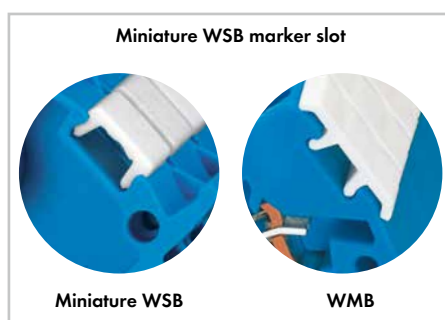

Marking Conductors from 0.25 ... 16 mm²





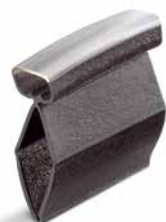

211 Series

Marking sleeve, halogen-free for one marker, to be fitted prior to conductor termination	Marking sleeve, halogen-free for one marker, to be fitted prior to conductor termination	Marking sleeve, halogen-free, for cable tie, for one marker, can also be fitted after install
--	--	---



Description	Item No.	Pack. Unit	Description	Item No.	Pack. Unit	Description	Item No.	Pack. Unit
Marking sleeve, 12 mm long			Marking sleeve, 23 mm long			Marking sleeve, 23 mm long		
for 1.6 ... 3.2 mm conductor diameter or 0.25 ... 1.5 mm ² cross-section	211-112	2000	for 1.6 ... 3.2 mm conductor diameter or 0.25 ... 1.5 mm ² cross-section	211-122	2000	for 10 mm ² conductors and larger for 6 mm Ø cables and larger	211-129	1000
for 2.2 ... 4.5 mm conductor diameter or 0.5 ... 4 mm ² cross-section	211-113	2000	for 2.2 ... 4.5 mm conductor diameter or 0.5 ... 4 mm ² cross-section	211-123	2000	Note: Only use with markers for plotter.		
for 3.7 ... 5.9 mm conductor diameter or 2.5 ... 6 mm ² cross-section	211-114	1000	for 3.7 ... 5.9 mm conductor diameter or 2.5 ... 6 mm ² cross-section	211-124	1000	Cable tie set 2.5 x 100 mm, 25 cable ties per set	807-090/101-100	1
for 5.5 ... 10 mm conductor diameter or 10 ... 25 mm ² cross-section	211-115	1000	for 5.5 ... 10 mm conductor diameter or 10 ... 25 mm ² cross-section	211-125	1000			

Accessories, 211 Series

Markers, for thermal transfer printer,  3,000 markers per roll; 12 mm long ○ 211-111 1	Markers, for thermal transfer printer,  3,000 cards per roll; 23 mm long ○ 211-121 1
Markers, for plotter,  57 markers per card, 12 mm long ○ 211-110 1	Markers, for plotter,  34 markers per card, 23 mm long ○ 211-120 1
Carrier plate for marker cards (IP 350 Plotter)  258-370 1	Carrier plate for marker cards (IP 350 Plotter)  258-370 1



Slide the plotted or printed marker into the marking sleeve receptacle. Exchanging the marker is also possible after the conductor has been terminated.

Applications



Marking conductors via marking sleeves.

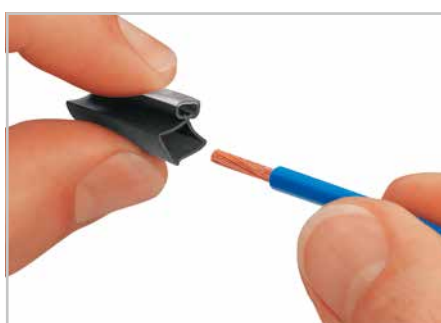

Compress the sleeve and slide it onto the conductor to be marked.



Attach the marking sleeve (211-129) to individual cables or conductors via cable ties (807-090/101-100).

Conductor Markers for Thread-On Mounting Self-Laminating Labels for Cable Marking 211 Series

Conductor markers for thread-on mounting
Shrink tubes for conductor marking

Self-laminating labels for cable marking
on DIN A4 sheets or roll
Cable diameter: approx. 3 ... 14 mm

Conductor markers

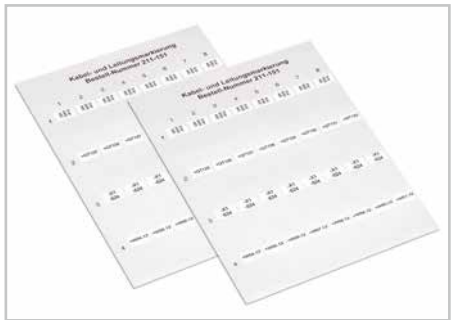

Self-laminating labels are available on A4 sheets for laser printers (plotters) or are supplied on roll for thermal transfer printers.

Description	Item No.	Pack. Unit	Description	Item No.	Pack. Unit
Conductor markers for thread-on mounting, 1,000 markers/roll, for 0.75 ... 1.5 mm ² conductors	211-861	1	Labels on DIN A4 sheets, for laser printer		
1,000 markers/roll, for 2.5 ... 6 mm ² conductors	211-862	1	Marking surface: "S" = 9 mm x "B" = 17 mm "L" = 35 mm for max. 8 mm cable diameter 70 labels per sheet		
1,000 markers/roll, for 6 ... 16 mm ² conductors	211-863	1	211-150	20	
Shrink tubes for conductor marking, halogen-free, 2:1 shrink ratio			Marking surface: "S" = 13 mm x "B" = 21 mm "L" = 56 mm for max. 14 mm cable diameter 32 labels per sheet		
20 m/roll			211-500	25	
○ 2.4 mm Ø, 0.25 ... 0.75 mm ²	211-500	1	Conductor markers, plain		
● 2.4 mm Ø, 0.25 ... 0.75 mm ²	211-500/000-002	1	Marking surface: 9 x 18 mm, 1,000 markers per roll		
○ 3.2 mm Ø, 0.75 ... 1 mm ²	211-501	1	211-855	1	
● 3.2 mm Ø, 0.75 ... 1 mm ²	211-501/000-002	1	Marking surface: 15 x 22 mm, 1000 markers per roll		
○ 4.8 mm Ø, 1 ... 2.5 mm ²	211-502	1	211-856	1	
● 4.8 mm Ø, 1 ... 2.5 mm ²	211-502/000-002	1	Marking surface: 18 x 44 mm, 500 markers per roll		
○ 6.4 mm Ø, 4 ... 6 mm ²	211-503	1	211-857	1	
● 6.4 mm Ø, 4 ... 6 mm ²	211-503/000-002	1			
15 m/roll					
○ 9.5 mm Ø, 10 ... 16 mm ²	211-504	1			
● 9.5 mm Ø, 10 ... 16 mm ²	211-504/000-002	1			
○ 12.7 mm Ø, 25 ... 35 mm ²	211-505	1			
● 12.7 mm Ø, 25 ... 35 mm ²	211-505/000-002	1			
○ 19.0 mm Ø, 35 ... 50 mm ²	211-506	1			
● 19.0 mm Ø, 35 ... 50 mm ²	211-506/000-002	1			



Remove the printed label from the sheet or roll.

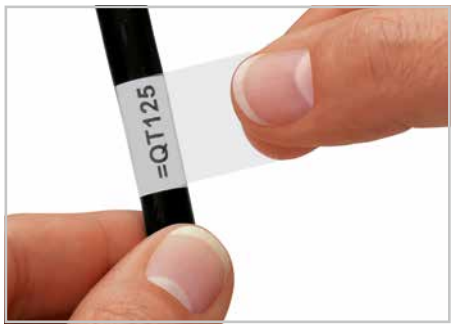

Wrap the label around the conductor or cable. The transparent laminate protects the marking.

Application and Dimensions



Conductor Markers for Thread-On Mounting

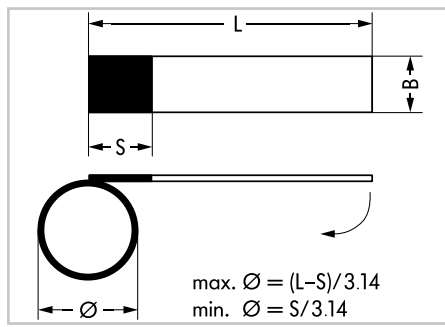











Dimensions of self-laminating label (in mm)



Compress the shrink tube and slide it onto the conductor to be marked.

I/O Marking, Labels and Push-Button Markers

210 / 211 Series

	Description	Technical Data	Color/Item No.
	Markers for I/O components (requires 258-371 Carrier Plate for plotting)	Plotter, 12 x 7 mm	○ 211-211
	Label roll, polyester, self-adhesive	15 x 6 mm, 3,000 labels/roll	○ 210-805
		15 x 6 mm, 3,000 labels/roll	● 210-805/000-002
		15 x 9 mm, 3,000 labels/roll	○ 210-806
		15 x 9 mm, 3,000 labels/roll	● 210-806/000-002
		20 x 8 mm, 3,000 labels/roll	○ 210-807
		20 x 8 mm, 3,000 labels/roll	● 210-807/000-002
		9.5 x 25 mm, 1,500 labels/roll	○ 210-808
		5 x 35 mm, 3,000 labels/roll	● 210-810
	Label roll, fabric, self-adhesive	20 x 7 mm, 3,000 labels/roll	○ 210-811
		20 x 7 mm, 3,000 labels/roll	● 210-811/000-002
	Type plates, polyester	70 x 33 mm, 500 plates/roll	○ 210-801
		70 x 33 mm, 500 plates/roll	○ 210-802
		44 x 99 mm, 500 plates/roll	○ 210-803
		44 x 99 mm, 500 plates/roll	○ 210-804
	Continuous labels, polyester, self-adhesive for PCB and MCS	2.3 mm wide, 9 lines at 25 m	○ 210-831
		3 mm wide, 9 lines at 25 m	○ 210-832
		5 mm wide, 5 lines at 25 m	○ 210-834
		6 mm wide, 5 lines at 25 m	○ 210-833
	Push-button markers, semi-permanent adhesive	26.5 x 18 mm, 1,000 markers/roll	○ 210-850
		27.5 x 17.5 mm, 1,000 markers/roll	○ 210-856
		22 x 22 mm, 1,000 markers/roll	○ 210-858
		27 x 27 mm, 1,000 markers/roll	○ 210-860
		27 x 12.5 mm, 1,000 markers/roll	○ 210-862
	Plastic covers for push-button markers	26.5 x 18 mm, transparent, 100 covers	○ 210-851
		27.5 x 17.5 mm, transparent, 100 covers	○ 210-857
		22 x 22 mm, transparent, 100 covers	○ 210-859
		27 x 27 mm, transparent, 100 covers	○ 210-861
		27 x 12.5 mm, transparent, 100 covers	○ 210-863
	Push-button markers, permanent adhesive	27 x 19 mm, 350 markers/roll	○ 210-852
		27 x 18 mm, 350 markers/roll	○ 210-855
	Universal push-button frame for 210-852	27 x 19 mm, transparent, 100 frames	○ 210-853
	Label roll DD (device designation), polyester	28 x 28 mm, 175 µm thick, 500 labels/roll	○ 210-854
	Marking strip	15 mm, 50 m roll	○ 210-701

Group Marker Carriers

End Stops

209 / 210 / 249 / 709 / 2002 / 2009 Series

TOPJOB® S group marker carriers	Group marker carriers	Screwless end stops for DIN-35 rail
---------------------------------	-----------------------	-------------------------------------

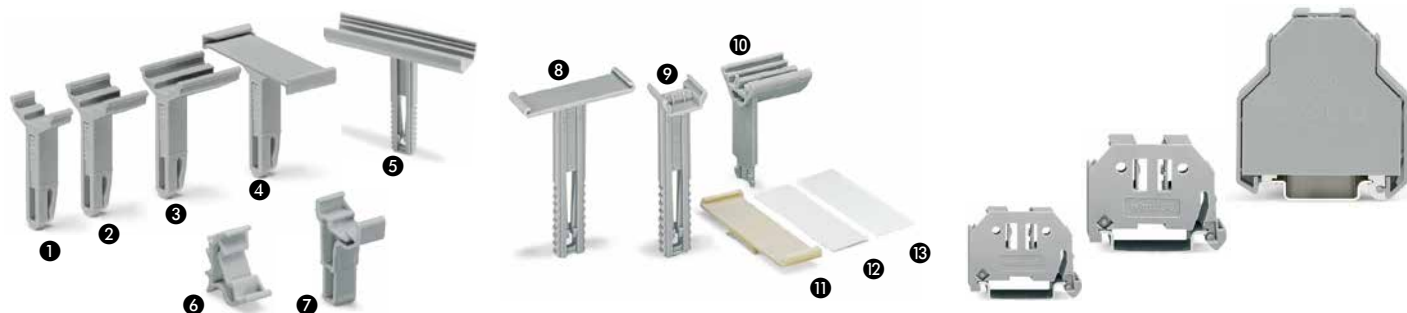

Item No.	Pack. Unit	Item No.	Pack. Unit	Item No.	Pack. Unit
TOPJOB® S group marker carriers, snap-on type for jumper slot, for WMB Multi Marking System, WMB Inline and marking strips		Height-adjustable group marker carriers, for 249-116 and 249-117 end stops, for 1 marker or self-adhesive label and transparent protection covers		Screwless end stop, for DIN-35 rail 6 mm wide	249-116 100 (4 x 25)
5 mm wide 2009-191 ①	50 (2x25)	10 mm wide 249-119 ⑧	50 (2x25)	Screwless end stop, for DIN-35 rail 10 mm wide	249-117 50 (2 x 25)
10 mm wide 2009-192 ②	50 (2x25)	6 mm wide 249-120 ⑧	50 (2x25)	Screwless end stop, for DIN-35 rail 14 mm wide	249-197 10
15 mm wide 2009-193 ③	50 (2x25)	for 2 WSB Quick markers each or 1 x marking strip (2009-110)			
TOPJOB® S group marker carrier snap-on type for jumper slot, for marking strips		249-118 ⑨	100 (4x25)		
10 mm wide 2009-196 ④	50 (2x25)	Group marker carrier, fits into jumper slot of rail-mounted terminal blocks, for up to 3 WMB markers			
TOPJOB® S group marker carrier, snap-on type for end stops (249-116 and 249-117), adjustable in height from 45 to 61 mm for 9 WMB markers or marking strips		15 mm wide 209-140 ⑩	50		
12.2 mm wide 2009-163 ⑤	50 (2x25)	Group marker carrier, snaps into plastic end stop			
Marker carrier, for lateral marker slots		10 mm wide 209-112 ⑪	50		
5 mm wide 2009-198 ⑥	200 (8x25)	Markers, from white cardboard, for self-marking, 100 markers per sheet			
Marker carrier, for jumper slots (2002 Series)		209-113 ⑫	1 sheet		
5 mm wide 2002-161 ⑦	100 (4x25)	Stickers, for self-marking, 100 stickers per sheet			
		210-345	1 sheet		
		Protection cover, transparent			
		209-114 ⑬	50		
		Carrier-through element, height-adjustable			
		709-118	25		
		Carrier-end element, height-adjustable			
		709-119	25		

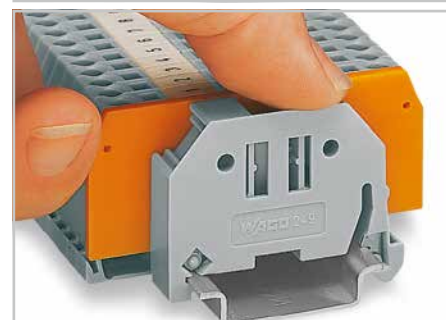
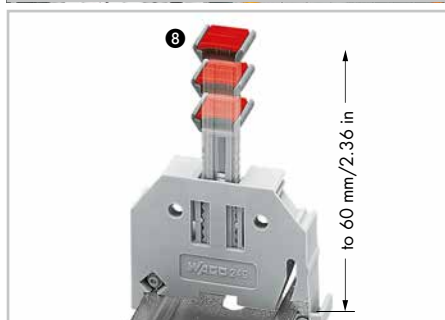
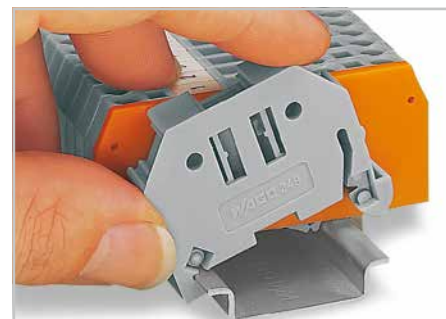
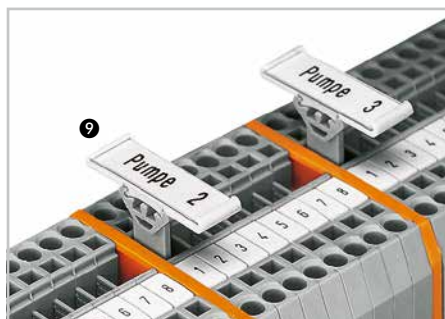

11

Sealable, Transparent Covers for Rail-Mounted Terminal Blocks

Collective Carriers for Jumpers

209 / 282 / 709 / 2009 Series

Cover and cover carrier, type 1, suitable for:
279 ... 282 Series Rail-Mounted Terminal Blocks
264 Series Miniature Rail-Mounted Terminal Blocks

Cover and cover carrier, type 2, suitable for:
283 ... 285 Series Rail-Mounted Terminal Blocks
280/281 Series Double-/Triple-Deck Terminal Blocks
280 Series Sensor/Actuator Terminal Blocks
282 Series Disconnect/Test Terminal Blocks for Transformer Circuits

Switchgear cabinet drawer
Collective carrier for adjacent jumpers
Collective carriers for jumpers



Color	Item No.	Pack. Unit	Color	Item No.	Pack. Unit	Item No.	Pack. Unit
Cover, type 1, 1 m long, for cover carrier (type 1), transparent			Cover, type 2, 1 m long, for cover carrier (type 2), transparent			Switchgear cabinet drawer, DIN-35 rail mount drawer	
	709-153	10		709-154	1	709-591	1

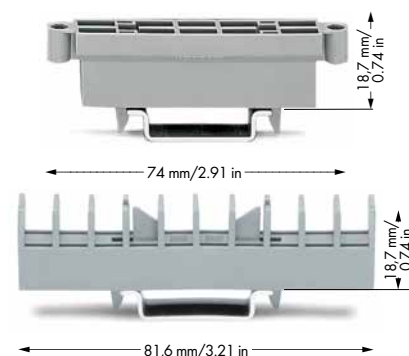

Color	Item No.	Pack. Unit	Color	Item No.	Pack. Unit	Color	Item No.	Pack. Unit
Cover carrier, type 1, incl. mounting/securing screws and knurled nuts			Cover carrier, type 2, incl. mounting/securing screws and knurled nuts			Collective carrier for adjacent jumpers, 10.7 mm wide		
○	709-167	10	○	709-168	10	○	209-100	50 (2x25)
Accessories, 709 Series			Marking card with 6 marking strips, plain			Collective carrier for TOPJOB® S Jumpers, 16.9 mm wide		
Spare mounting/securing screws			709-183			25		
209-196			1			Suitable for 2000 ... 2016 Series Jumpers		
200 (8x25)						Collective carrier for jumpers, 15.8 mm wide		
Spare knurled nuts						25		
210-549						Suitable for jumpers for: transverse switching terminal blocks (282-811) and longitudinal switching disconnect terminal blocks (282-821)		
100 (4x25)								



Application example:
Cover (type 1) with safety warning and lead seals.

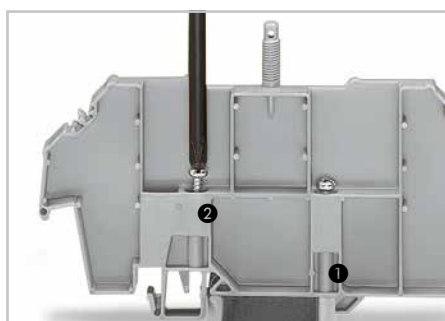

1 Mounting screw - prevents the cover carrier from being moved on the rail.
2 Securing screw - prevents lifting off from rail.



The switchgear cabinet drawer is the ideal place to store small parts that are not routinely used (e.g., instructions, test plug adapters, jumpers, spare fuses).

Carrier Rails

Angled Support Brackets

210 Series

Carrier rail, 35 x 7.5 mm, 1 mm thick, per IEC 60715, steel, zinc-plated, I _N 76 A (reference length of 1 m)	Carrier rail, 35 x 15 mm, 1.5 / 2.3 mm thick, per IEC 60715, steel, zinc-plated, I _N 125 A (reference length of 1 m)	Carrier rail, 35 x 15 mm, 2.3 mm thick, per IEC 60715, copper, unplated, I _N 309 A (reference length of 1 m)
---	---	---



Length	Item No.	Pack. Unit	Length	Item No.	Pack. Unit	Length	Item No.	Pack. Unit
Steel carrier rail, 35 x 7.5 mm, 1 mm thick, unslotted, 2 m long	210-113	10	Steel carrier rail, 35 x 15 mm, 1.5 mm thick, unslotted, 2 m long	210-114	10	Copper carrier rail, 35 x 15 mm, 2.3 mm thick, unslotted, 2 m long	210-198	10
Steel carrier rail, 35 x 7.5 mm, 1 mm thick, slotted, 2 m long	210-112	10	Steel carrier rail, 35 x 15 mm, 1.5 mm thick, slotted, 2 m long	210-197	10			
			Steel carrier rail, 35 x 15 mm, 2.3 mm thick, unslotted, 2 m long	210-118	10			

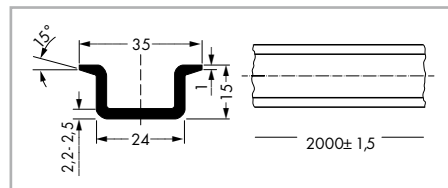
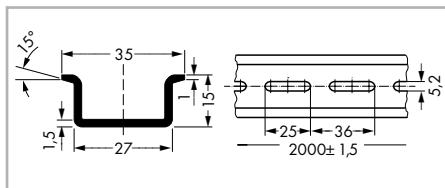
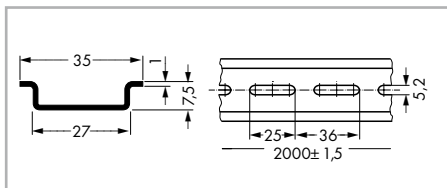

Carrier rail, 35 x 7.5 mm, 1.5 mm thick, per IEC 60715, aluminum, unplated, I _N 76 A (reference length of 1 m)	Carrier rail, 35 x 15 mm, 2.3 mm thick, per EN 60715, PA6-GV30-V0 plastic	Accessories
---	---	-------------



Length	Item No.	Pack. Unit	Length	Item No.	Pack. Unit
Aluminum carrier rail, 35 x 7.5 mm, 1.5 mm thick, unslotted, 2 m long	210-196	10	Plastic carrier rail, 35 x 15 mm, 2.3 mm thick, unslotted, 2 m long	210-509	1

	Item No.	Pack. Unit
Angled support bracket, without screw	210-148	10
Screw M 5 x 8, for angled support bracket	210-149	100 (5x20)
Rail end cap, for DIN-35 rail (7.5 mm high) gray	210-109	50 (2x25)

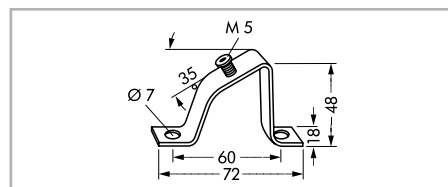
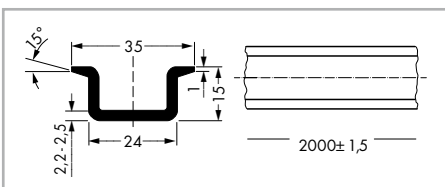
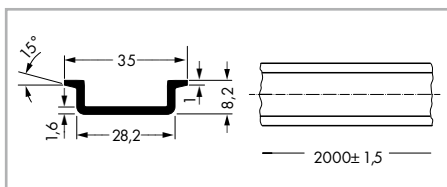

Operating Tools

209 / 210 / 279 / 280 / 282 Series

<p>Operating tools, per DIN 5264, with a partially insulated shaft, ideal for operating WAGO terminal blocks</p>	<p>Insulated multipole operating tools for front-entry terminal blocks</p>	<p>Short operating tools, per DIN 5264, with a partially insulated shaft, ideal for operating WAGO terminal blocks</p>
---	---	---



Item No.	Pack. Unit	Item No.	Pack. Unit	Item No.	Pack. Unit
<p>Operating tool with a partially insulated shaft, type 1, (2.5 x 0.4) mm blade, suitable for 218, 233, 234, 235, 250, 253, 279, 726, 727, 733, 734, 735, 750, 752, 753, 770, 2000, 2001, 2020 Series</p> <p>210-719 1</p>		<p>Operating tool, insulated, suitable for 279 Series</p> <p>1-pole 209-129 1</p> <p>2-pole 279-432 1</p> <p>3-pole 279-433 1</p> <p>10-pole 279-440 1</p>		<p>Operating tool, (2.5 x 0.4) mm blade, suitable for 218, 233, 234, 235, 250, 253, 279, 726, 727, 733, 734, 735, 750, 752, 753, 770, 2000, 2001, 2020, 2734 Series</p> <p>210-647 1</p>	
<p>Operating tool with a partially insulated shaft, type 2, (3.5 x 0.5) mm blade, suitable for 231, 232, 236, 255, 256, 257, 260, 261, 262, 264, 270, 280, 281, 290, 721, 722, 736, 737, 738, 742, 745, 775, 776, 777, 769, 780, 781, 804, 869, 870, 880, 2002, 2003, 2004, 2005, 2022 Series</p> <p>210-720 1</p>		<p>suitable for 264*, 280, 281** Series</p> <p>1-pole 209-130 1</p> <p>2-pole 280-432 1</p> <p>3-pole 280-433 1</p> <p>4-pole 280-434 1</p> <p>5-pole 280-435 1</p> <p>6-pole 280-436 1</p> <p>7-pole 280-437 1</p> <p>8-pole 280-438 1</p> <p>9-pole 280-439 1</p> <p>10-pole 280-440 1</p>		<p>Operating tool, angled, (2.5 x 0.4) mm blade, suitable for 279, 2000, 2001, 2020 Series</p> <p>210-648 1</p>	
<p>Operating tool with a partially insulated shaft, type 3, (5.5 x 0.8) mm blade, suitable for 282, 283, 284, 285, 745, 782, 783, 784, 785, 2006, 2010, 2016 Series</p> <p>210-721 1</p>		<p>suitable for 281 Series</p> <p>5-pole 281-440 1</p>		<p>Operating tool, angled, (3.5 x 0.5) mm blade, suitable for 231, 232, 236, 255, 256, 257, 260, 261, 262, 264, 280, 281, 721, 722, 736, 737, 738, 742, 745, 804, 869, 870, 880, 2002, 2004, 2022 Series</p> <p>210-658 1</p>	
<p>Set of operating tools with a partially insulated shaft, type 1, (2.5 x 0.4) mm blade, type 2, (3.5 x 0.5) mm blade, type 3, (5.5 x 0.8) mm blade</p> <p>210-722 1</p>		<p>*only 1- and 2-pole</p> <p>**only up to 3-pole</p>			

Application notes:



Set of operating tools in a box



Commoning front-entry disconnect terminal blocks via comb-style jumper bar using a 10-pole operating tool.



The operating tools with blade dimensions per DIN 5264 are ideal for operating 280 Series Front-Entry Sensor/Actuator Terminal Blocks.

Operating Tools for MCS MIDI

231 / 233 / 236 / 733 / 734 / 769 Series

Operating tools for factory wiring of PCB terminal strips	Operating levers for male and female connectors equipped with CAGE CLAMP®	Operating tools for male and female connectors equipped with CAGE CLAMP®
--	--	---



Color	Item No.	Pack. Unit	Color	Item No.	Pack. Unit	Color	Item No.	Pack. Unit
Operating tool, for 233, 733, 2060 Series			Operating lever, for 231, 232, 721, 722, 723, 731, 732 Series			Operating tool, for 231, 232, 721, 722, 723, 731, 732 Series		
● metal, partially insulated	233-335 ①	1	○	231-131 ⑥	100	○	231-159 ⑬	100
○ insulated	233-332 ②	25	●	231-291 ⑦	100	●	231-231 ⑭	100
● insulated	233-331 ③	25	for 734 Series			for 734 Series		
for 236 Series			○	734-230 ⑧	100	○	734-190 ⑮	100
○ insulated	236-332 ④	400	●	734-191 ⑨	100	●	734-231 ⑯	100
metal	236-335 ⑤	1	for 733 Series					
			○	733-130 ⑩	100			
			●	733-191 ⑪	100			
			for 769 Series					
			○	769-434 ⑫	2000			

Application notes:

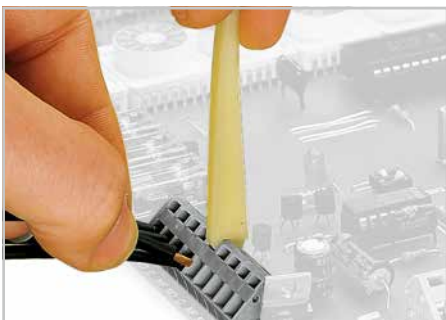

Conductor termination via operating tool



Conductor termination via operating lever



Conductor termination parallel to CAGE CLAMP® actuation



Conductor termination via operating tool

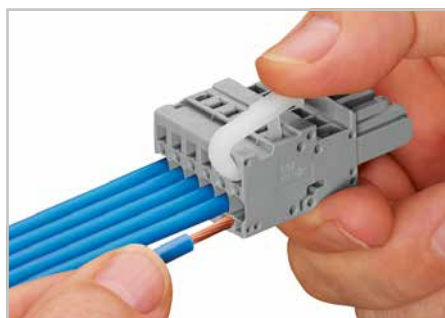

Conductor termination via operating lever

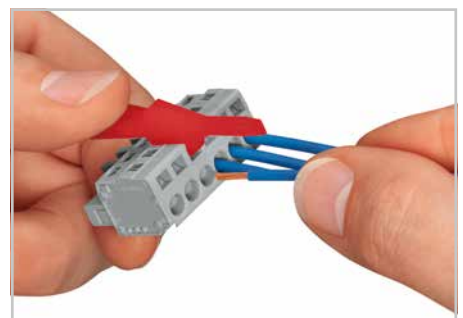

Conductor termination perpendicular to CAGE CLAMP® actuation

Operating Tools, Stickers for Operating Instructions 210 Series

Operating tools for male and female connectors equipped with CAGE CLAMP®	Stickers for operating instructions	Stickers for operating instructions
---	-------------------------------------	-------------------------------------

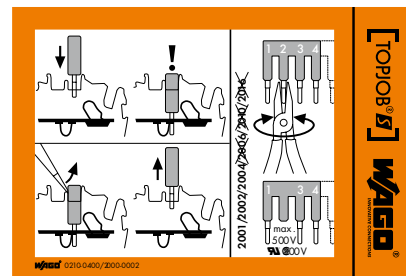
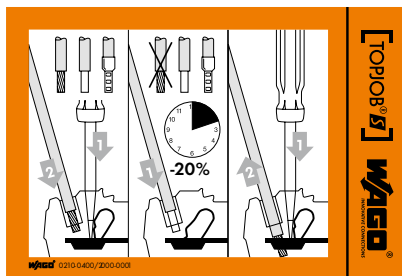

Color	Item No.	Pack. Unit	Item No.	Pack. Unit	Item No.	Pack. Unit
	Operating tools, 2.5/3.5 mm and 3.81 mm pin spacing, for MCS MICRO		Stickers for operating instructions, for TOPJOB® S Rail-Mounted Terminal Blocks 210-400/2000-001		Stickers for operating instructions, for TOPJOB® S Jumpers 210-400/2000-002	
●	210-251	1				
	5/5.08 mm and 7.5/7.62 mm pin spacing, for MCS MIDI					
●	210-250	1				

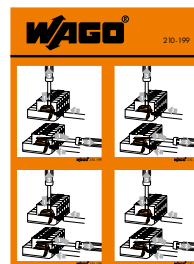
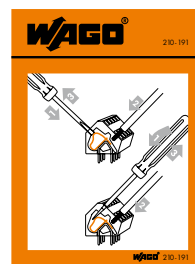
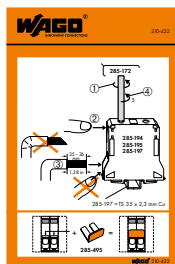
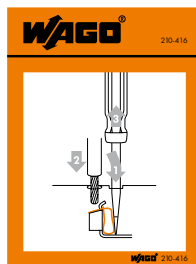

Color	Item No.	Pack. Unit	Item No.	Pack. Unit	Item No.	Pack. Unit
●	Operating tool, for X-COM®-SYSTEM 769 Series Male and Female Connectors		Stickers for operating instructions, for CAGE CLAMP®, universal 210-416		Stickers for operating instructions, for PCB terminal blocks 236 Series 210-191 736/737/738 Series 210-406	
	210-490	1		100		100
			Stickers for operating instructions, for 95 mm² high-current terminal blocks, 285 Series 210-422		Stickers for operating instructions, for MCS with CAGE CLAMP® 210-199	
				100		100



Conductor termination via operating tool

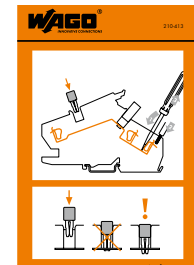
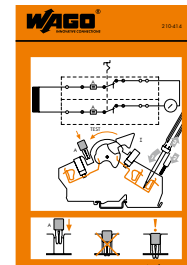
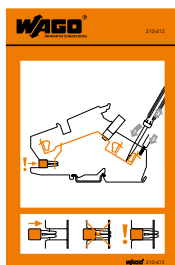
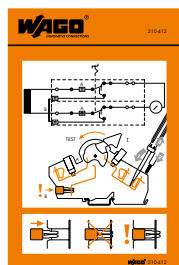

Item No.	Pack. Unit	Item No.	Pack. Unit
Stickers for operating instructions, for 282-870 Disconnect/Test Terminal Block (current transformer) 210-412	100	Stickers for operating instructions, for 282-860 Disconnect/Test Terminal Block (voltage transformer) 210-414	100
Stickers for operating instructions, for 282-865 Through Terminal Block (current transformer) 210-415	100	Stickers for operating instructions, for 282-866 Through Terminal Block (voltage transformer) 210-413	100



Cable Cutter Cable Strippers 206 Series

Cable cutter per VDE up to 35 mm ²	Cable stripper for round cables 2.5 ... 11 mm Ø	Cable stripper for round cables 4.5 ... 45 mm Ø
---	---	---



Item No.	Pack. Unit	Item No.	Pack. Unit	Item No.	Pack. Unit
Cable cutter, for copper or aluminum conductors up to 35 mm ²		Cable stripper, for round cables with 2.5 ... 11 mm outer diameter		Cable stripper, for round cables with 4.5 ... 45 mm outer diameter	
206-118	1	206-171	1	206-174	1

Accessories, 206 Series

	Replacement blade, for 2.5 ... 11 mm Ø  206-170	Replacement blade, for 4.5 ... 45 mm Ø  206-173
	1	1

Application notes:



Cutting a cable.

206-171 Cable Stripper

- 10-position adjustment wheel ensures consistent stripping results
- Fine adjustability via 10-position blade cutting depth adjustment
- Strips the sheath from multi-core and fiber optic cables up to 11 mm diameter
- Safe and easy to use through closed stripping cavity

206-174 Cable Stripper

- Safe and easy to use: three locking positions for circular, longitudinal and spiral cuts
- High cable stripping capacity of up to 45 mm diameter
- Ergonomic design features rests with thumb, index and pinky fingers to ease raising of the cable retention hook
- Replacement blades can be stored within the tool's handle



Operating instructions for 206-171 Cable Stripper

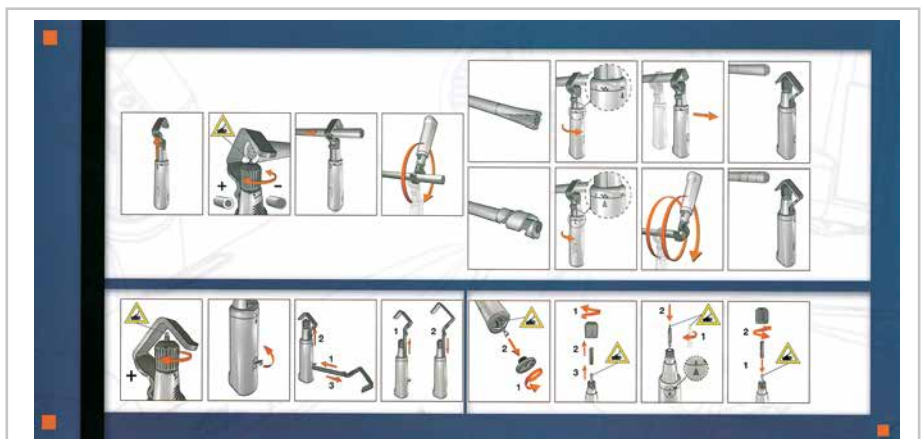

Operating instructions for 206-174 Cable Stripper

Wire Strippers

206 Series

"Quickstrip 10" wire stripper

0.02 ... 10 mm² "f-st"

"Quickstrip 16" wire stripper

4 ... 16 mm²



Item No.	Pack. Unit	Item No.	Pack. Unit
"Quickstrip 10" wire stripper, 0.02 ... 10 mm ² "f-st" (6 mm ² "s")		"Quickstrip 16" wire stripper, 4 ... 16 mm ²	
Cutter for conductors up to 10 mm ² "f-st" (1.5 mm ² "s")		Cutter for conductors up to 10 mm ² "f-st" (1.5 mm ² "s")	
206-124	1	206-125	1





Stripping a conductor.



Cutting a conductor.

Accessories, 206 Series

"Standard" blade cassette, 0.02 ... 10 mm ²		"Standard" blade cassette, 4 ... 16 mm ²	
 206-126	1	 206-128	1
"V" blade cassette, 0.1 ... 4 mm ² for PTFE			
 206-127	1		

Application notes:

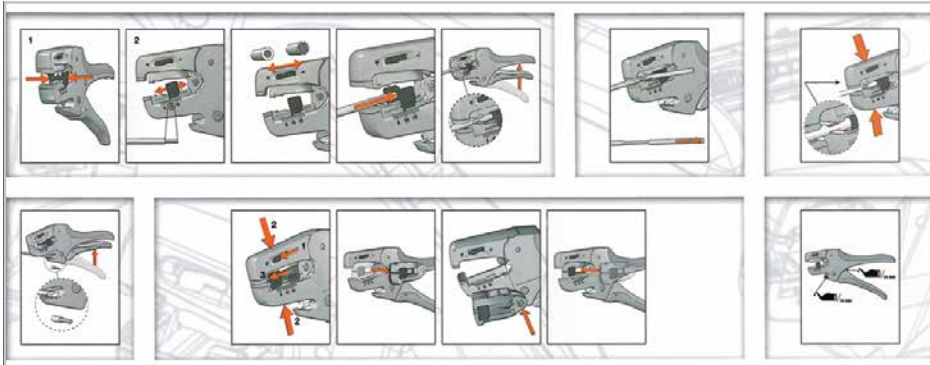

Operating instructions for wire strippers

Crimping Tools

206 Series

"Variocrimp 4" crimping tool
0.25 ... 4 mm²

"Variocrimp 16" crimping tool
6 ... 16 mm²

Crimping Tool 25,
10 mm², 16 mm² and 25 mm²

Crimping Tool 50,
35 mm² and 50 mm²



Item No.	Pack. Unit	Item No.	Pack. Unit
"Variocrimp 4" crimping tool, for insulated and uninsulated ferrules, crimping range: 0.25 ... 4 mm ²		Crimping Tool 25, for insulated and uninsulated ferrules, crimping range: 10 mm ² , 16 mm ² and 25 mm ²	
206-204	1	206-225	1
"Variocrimp 16" crimping tool, for insulated and uninsulated ferrules, crimping range: 6 ... 16 mm ²		Crimping Tool 50, for insulated and uninsulated ferrules, crimping range: 35 mm ² and 50 mm ²	
206-216	1	206-250	1

What is a "gas-tight" connection?

In a gas-tight connection, the conductor and the ferrule are compressed, eliminating all spaces. Under normal atmospheric conditions, neither a liquid nor gaseous medium can penetrate the crimped connection. Oxidation between crimped single conductors is prevented, virtually eliminating the possibility of any increase in the crimped connection's resistance. In some exceptional cases, minute, isolated spaces may be present. However, these instances can be considered as closed off due to the twisted conductor.

Inadequate crimping can allow the conductor to be pulled out of the connection. Hollow spaces also remain, permitting oxidation formation and leading to an increase in contact resistance.

Elevated resistance is detrimental for both signal transmission (signal flow is damped) and power transmission, resulting in power loss and contact heating (risk of fire).

Crimping tools with built-in ratchets are recommended (e.g., **WAGO Crimping Tools**). These tools only open after the crimping process has been fully completed. Space-saving crimping from all four sides is ideal for spring clamp termination.

Ferruled conductor sizes specified for WAGO products are based on this crimping method.

Application notes:



Insert ferruled conductor into crimping station. Squeeze handles until ratchet mechanism is released.

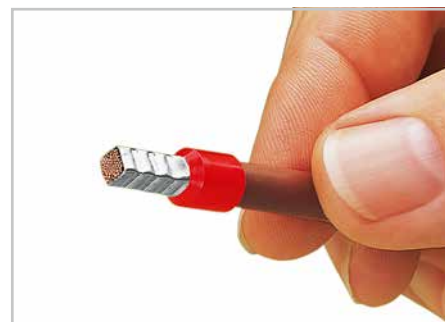

A perfect gas-tight crimp - both electrically and mechanically reliable

- The built-in crimping pressure control of "Variocrimp 4" automatically adjusts the crimping force to the conductor cross-section. Select the wire gauge on "Variocrimp 16" before crimping.
- Only one crimping station is needed to handle the specified conductor sizes
- Uniform, compact crimping on all four sides for high conductor retention
- No need to center the conductor into the ferrule
- Conductor and ferrule insertion possible from both sides (for left- and right-handers)
- Built-in ratchet mechanism ensures gas-tight crimp connection
- Crimping tools open automatically after crimping operation is complete
- Comfortable handles for operator

Conductor Size (mm ²)	Conductor Retention Force ≥ ... N
0.25	30
0.5	50
0.75	60
1.0	70
1.5	80
2.5	100
4	120
6	160
10	180
16	200
25	270
35	380
50	470

All crimping tools are factory-calibrated. We recommend that you periodically check to see if the crimping tool functions as expected after approximately 3,000 crimps. The accompanying table allows you to check the crimping quality. For additional information on care and maintenance, please refer to the instruction leaflet.

Ferrules

216 Series

Sleeve for mm ²	Color AWG	Strip Length mm	L	L1	D	D1	D2	Item No.	Pack. Unit	
Insulated ferrules, extra long, for TOBJOB® S Terminal Blocks										
0.5	22	○	12.0	16.0	10.0	3.1	2.6	1.0	216-241	1000
0.75	20	○	12.0	16.0	10.0	3.3	2.8	1.2	216-242	1000
0.75	20	○	14.0	18.0	12.0	3.3	2.8	1.2	216-262	1000
1.0	18	●	12.0	16.0	10.0	3.5	3.0	1.4	216-243	1000
1.0	18	●	14.0	18.0	12.0	3.5	3.0	1.4	216-263	1000
1.5	16	●	12.0	16.0	10.0	4.0	3.5	1.7	216-244	1000
1.5	16	●	14.0	18.0	12.0	4.0	3.5	1.7	216-264	1000
1.5	16	●	20.0	24.0	18.0	4.0	3.5	1.7	216-284	1000
2.5	14	●	12.0	17.0	10.0	4.7	4.2	2.2	216-246	1000
2.5	14	●	14.0	19.0	12.0	4.7	4.2	2.2	216-266	1000
2.5	14	●	20.0	25.0	18.0	4.7	4.2	2.2	216-286	1000
4.0	12	○	14.0	20.0	12.0	5.4	4.8	2.8	216-267	500
4.0	12	○	20.0	26.0	18.0	5.4	4.8	2.8	216-287	500
6.0	10	●	14.0	20.0	12.0	6.9	6.3	3.5	216-208	500
6.0	10	●	20.0	26.0	18.0	6.9	6.3	3.5	216-288	500
10.0	8	●	20.0	28.0	18.0	8.4	7.6	4.5	216-289	500
16.0	6	●	23.0	28.0	18.0	9.6	8.8	5.8	216-210	500



Insulated ferrules, in standard length										
0.25	24	●	7.5	10.5	6.0	2.5	2.0	0.8	216-321	1000
0.25	24	●	9.5	12.5	8.0	2.5	2.0	0.8	216-301	1000
0.35	24	●	7.5	10.5	6.0	2.5	2.0	0.8	216-322	1000
0.34	24	●	9.5	12.5	8.0	2.5	2.0	0.8	216-302	1000
0.5	22	○	7.5	11.5	6.0	3.0	2.5	1.1	216-221	1000
0.5	22	○	9.5	13.5	8.0	3.0	2.5	1.1	216-201	1000
0.75	20	○	8.0	12.0	6.0	3.3	2.8	1.3	216-222	1000
0.75	20	○	10.0	14.0	8.0	3.3	2.8	1.3	216-202	1000
1.0	18	●	8.0	12.0	6.0	3.6	3.0	1.5	216-223	1000
1.0	18	●	10.0	14.0	8.0	3.6	3.0	1.5	216-203	1000
1.5	16	●	8.0	12.0	6.0	4.0	3.4	1.8	216-224	1000
1.5	16	●	10.0	14.0	8.0	4.0	3.4	1.8	216-204	1000
2.08	14	●	10.0	14.5	8.0	4.2	3.6	2.05	216-205	1000
2.5	14	●	10.0	15.0	8.0	4.8	4.2	2.3	216-206	1000
4.0	12	○	12.0	16.8	9.5	5.4	4.8	2.9	216-207	1000
6.0	10	●	14.0	20.0	12.0	6.8	6.2	3.5	216-208	100
10.0	8	●	16.0	21.0	12.0	8.1	7.5	4.6	216-209	100
16.0	6	●	23.0	28.0	18.0	9.6	8.8	5.8	216-210	100

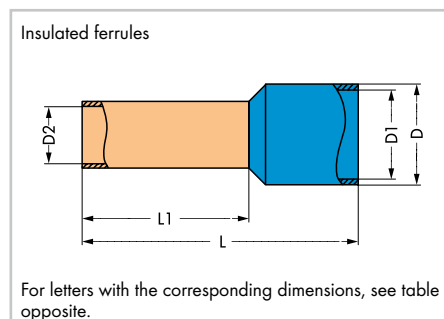

Insulated twin ferrules, extra long, for TOBJOB® S Terminal Blocks										
2 x 0.5	2 x 20	○	10.0	16.4	10.0	3.5x2.0	2.9x1.4	1.4	216-530	500
2 x 1.0	2 x 18	●	12.0	19.2	12.0	5.8x3.2	5.2x2.6	2.0	216-542	500
2 x 1.5	2 x 16	●	12.0	20.0	12.0	6.5x3.6	5.9x3.0	2.2	216-543	500
2 x 2.5	2 x 14	●	12.0	21.0	12.0	8.0x4.5	7.2x3.7	2.8	216-545	500
2 x 4.0	2 x 12	○	12.0	22.0	12.0	9.0x5.2	8.0x4.2	3.5	216-546	500
2 x 6.0	2 x 10	●	12.0	23.0	12.0	11.4x6.2	10.4x5.2	4.5	216-547	500

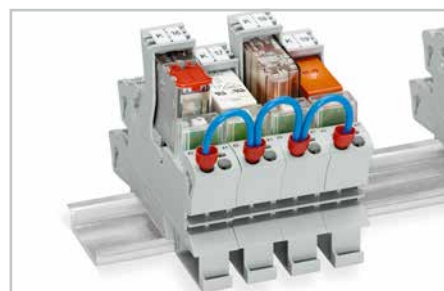

Wire bridge with twin ferrules

Uninsulated ferrules, in standard length										
0.25	24		5.0	5.0		1.7		0.75	216-151	1000
0.25	24		7.0	7.0		1.7		0.75	216-131	1000
0.34	24		5.0	5.0		1.7		0.85	216-152	1000
0.34	24		7.0	7.0		1.7		0.85	216-132	1000
0.5	22		6.0	6.0		2.1		1.0	216-121	1000
0.5	22		8.0	8.0		2.1		1.0	216-101	1000
0.75	20		6.0	6.0		2.3		1.2	216-122	1000
0.75	20		8.0	8.0		2.3		1.2	216-102	1000
1.0	18		6.0	6.0		2.5		1.4	216-123	1000
1.0	18		8.0	8.0		2.5		1.4	216-103	1000
1.5	16		6.0	6.0		2.8		1.7	216-124	1000
1.5	16		8.0	8.0		2.8		1.7	216-104	1000
2.5	14		10.0	10.0		3.4		2.2	216-106	1000
4.0	12		10.0	10.0		4.0		2.8	216-107	1000
6.0	10		12.0	12.0		4.7		3.5	216-108	250
10.0	8		12.0	12.0		5.8		4.5	216-109	250
16.0	6		12.0	15.0		7.5		5.8	216-110	250

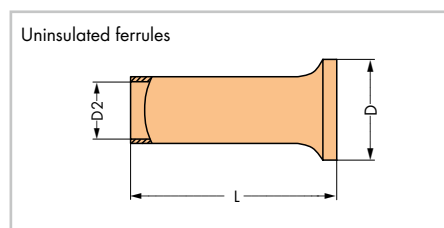
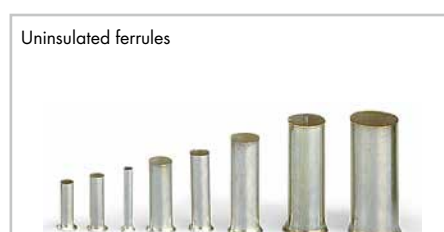

Test and Measurement Devices

206 Series

Voltage tester Profi III LED+	Voltage tester Profi III LCD+	Voltage tester Testboy
---	---	----------------------------------



Item No.	Pack. Unit	Item No.	Pack. Unit	Item No.	Pack. Unit
Profi III LED+ , 2-pole voltage tester with LED display, removable test probes (4 mm Ø) Measurement range: 6 ... 1000 VAC 6 ... 1,400 VDC Protection class: IP65 Resistance measurement: no Frequency measurement: no Data hold function: no		Profi III LCD+ , 2-pole voltage tester with LCD display, removable test probes (4 mm Ø) Measurement range: 3 ... 1,000 VAC TRMS 4 ... 1,400 VDC Protection class: IP65 Resistance measurement: 1 ... 1999 Ω Frequency measurement: 0 ... 1000 Hz Data hold function: yes		Testboy , non-contact voltage tester, with integrated flashlight Voltage range: 12 ... 1,000 VAC	
206-806	1	206-807	1	206-804	1

Accessories, 206 Series

Replacement test probes, 4 mm Ø (2 probes)	Replacement test probes, 4 mm Ø (2 probes)
206-808	206-808



Additional Profi III LED+ features:

- Automatic measurement range selection
- Single-pole phase testing AC >100 V
- Two-pole sequence testing (R and L)
- Continuity testing
- FI/RCD testing (30 mA) via buttons
- One-hand operation for SCHUKO® and CEE sockets
- LED torch lamp function (white)
- CAT IV 1,000 V
- TÜV/GS tested and approved
- IEC/EN 61243-3 (DIN VDE 0682-401)

Additional Profi III LCD+ features:

- Automatic measurement range selection
- Single-pole phase testing AC >100 V
- Two-pole sequence testing (R and L)
- Continuity testing
- FI/RCD testing (30 mA) via buttons
- One-hand operation for SCHUKO® and CEE sockets
- LED torch lamp function (white)
- Automatic backlight
- Auto power-off function (with countdown indicator)
- CAT IV 1,000 V
- TÜV/GS tested and approved
- IEC/EN 61243-3 (DIN VDE 0682-401)

The device reliably detects AC voltage in cables, sockets, fuses, switches, junction boxes and other installations.

The voltage tester detects:

- Live conductors
- Cable breaks
- Blown fuses (in cartridges or holders)
- Defective switches
- Defective lamps

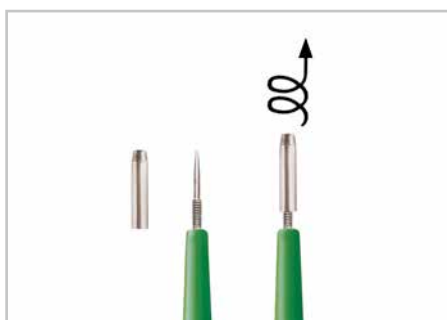

Profi-LED+ and Profi-LCD+

- Improved socket contact via Ø 4 mm test probes
- Removable test probes for small test ports (suitable for all WAGO terminal blocks)

Test and Measurement Devices

206 Series

Digital multimeter	Digital clamp meter	Digital clamp meter
Multi-Tester	Amp-Tester	Clamp-Multi-Tester



Item No.	Pack. Unit	Item No.	Pack. Unit	Item No.	Pack. Unit
Multi-Tester, digital multimeter with contact-less voltage tester, Carrying case (included) Measurement range: 600 V AC/DC; 10 A AC/DC Resistance measurement: up to 20 MΩ		Amp-Tester, digital clamp meter True RMS measurement Carrying case (included) Measurement range: 0.01 ... 200 A AC/DC, up to 400 Hz (sinus) Degree of protection: IP44		Clamp-Multi-Tester, Digital clamp meter DC and AC current up to 600 A True RMS and min./max. value measurement DC and AC voltage up to 600 V Manual or automatic measurement range selection	
206-810	1	206-815	1	206-816	1



Additional Multi-Tester features:

- Contact-less voltage test AC > 100 V (optical and acoustical)
- Resistance measurement: up to 20 MΩ
- Acoustical continuity test
- Diode test
- Data hold function
- Auto power-off function
- LED torch lamp function
- CAT IV 600 V
- TÜV/GS tested and approved
- IEC/EN 61010-1 (DIN VDE 0411)



Additional Amp-Tester features:

- AC and DC current measurement
- True RMS measurement
- Data hold function
- Maximum jaw opening: 21 mm Ø
- Compact design for measuring in tight spaces
- Resolution: 0.01 A at 40 A
- Resolution: 0.1 A at 200 A
- Sampling rate: 3 times per second
- Auto power-off function
- CAT III 300 V
- TÜV/GS tested and approved
- IEC/EN 61010-1 (DIN VDE 0411)



Additional Clamp-Multi-Tester features:

- Resistance up to 60 MΩ
- Capacitance measurement
- Acoustical continuity test
- Diode test
- Data hold function
- Large LCD with backlight
- LED measuring point lighting
- CAT III 600 V overvoltage protection
- IEC/EN 61010-1 (DIN VDE 0411)
- Includes batteries, measurement leads and carrying bag

Test Plugs, Test Pin, Banana Plugs 210 / 215 / 735 Series

Test plugs	Test pin	Banana plugs for 4 mm Ø sockets 0.08 ... 2.5 mm ² 28 ... 14 AWG 42 V I _N 20 A  9 ... 11 mm / 0.39 in.
------------	----------	---



Item No.	Pack. Unit	Item No.	Pack. Unit	Item No.	Pack. Unit
Test plug, 2 mm Ø, 500 mm cable length		Test pin, 1 mm Ø, with solder connection for test cable		Banana plugs, for 4 mm Ø sockets, orange, blue, yellow, white, black, color mixed	
● red	210-136	50	735-500	1	215-111
Test plug, 2.3 mm Ø, 500 mm cable length				Banana plugs, for 4 mm Ø sockets,	
● yellow	210-137	50		● orange	215-211
Step-down test plug, from 4mm socket to 2mm plug				● red	215-212
● red	210-297	100		● black	215-311
				● green	215-411
				● yellow	215-511
				○ white	215-611
				● blue	215-711
				○ gray	215-811
				● green-yellow	215-911

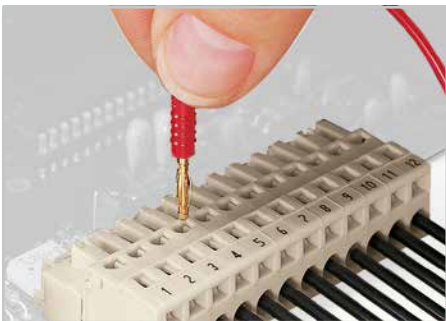

Testing with 2 mm Ø test plug.

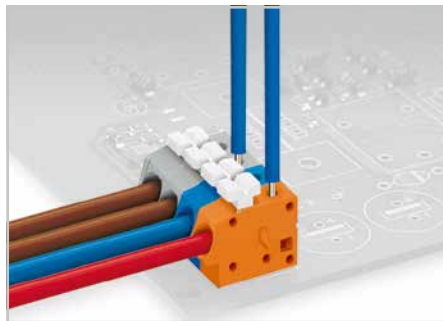

Testing with 1 mm Ø test pin - touch contact.

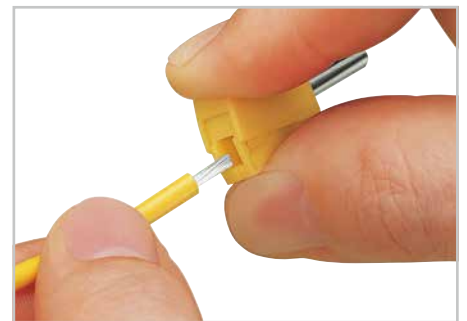

Conductor termination:
Press button fully and insert stripped conductor into square entry and release.





Testing with step-down test plug.



Banana plug used as test plug -
Testing via 209-170 Test Plug Adapter.

Test Plug Modules for 236, 736, 737 and 738 Series PCB Terminal Blocks 231 Series

Pin spacing: 5 mm / 0.197 in. Pin spacing: 7.5 mm / 0.295 in. 0.08 ... 2.5 mm² 28 ... 12 AWG 250 V / 2.5 kV / 2 (II)* 0.5 A  12 ... 13 mm / 0.47 ... 0.51 in.	Pin spacing: 5.08 mm / 0.2 in. Pin spacing: 7.62 mm / 0.3 in. 0.08 ... 2.5 mm² 28 ... 12 AWG 250 V / 2.5 kV / 2 (II)* 0.5 A  12 ... 13 mm / 0.47 ... 0.51 in.
---	---



Contact type A
Testing only when unwired.

Color	Item No.	Pack. Unit	Color	Item No.	Pack. Unit
Test plug module, contact type A with 10 mm contact lug, for 236 Series, can be snapped together			Test plug module, contact type A with 10 mm contact lug, for 236 Series, can be snapped together		
○ gray	231-127	100	● orange	231-128	100
Pin spacing: 5 mm / 0.197 in.			Pin spacing: 5.08 mm / 0.2 in.		
○ gray	231-161	100	● orange	231-125	100
Pin spacing: 7.5 mm / 0.295 in.			Pin spacing: 7.62 mm / 0.3 in.		
Test plug module, contact type A with 17 mm contact lug, for 280, 736, 737, 738 and 780 Series, can be snapped together			Test plug module, contact type A with 17 mm contact lug, for 736, 737 and 738, can be snapped together		
○ gray	231-126	100	● orange	231-426	100
Pin spacing: 5 mm / 0.197 in.			Pin spacing: 5.08 mm / 0.2 in.		
Test plug module, contact type B with 18 mm contact lug, for 280, 736, 737, 738 and 780 Series, can be snapped together			Test plug module, contact type B with 18 mm contact lug, for 736, 737 and 738, can be snapped together		
○ gray	231-155	100	● orange	231-455	100
Pin spacing: 5 mm / 0.197 in.			Pin spacing: 5.08 mm / 0.2 in.		
Test plug module, contact type B with 18 mm contact lug, for 736 and 737 Series, can be snapped together					
Pin spacing: 7.5 mm / 0.295 in.					
○ gray	231-456	100			



Contact type B
Testing only when wired –
0.75 ... 1.5 mm² "fst" or 0.5 mm² "sol."

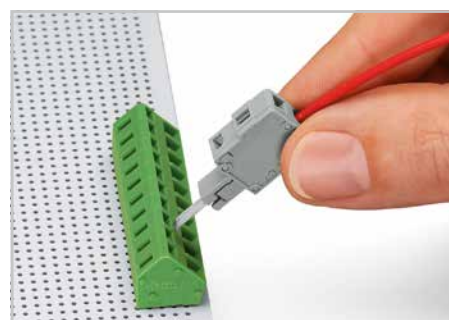

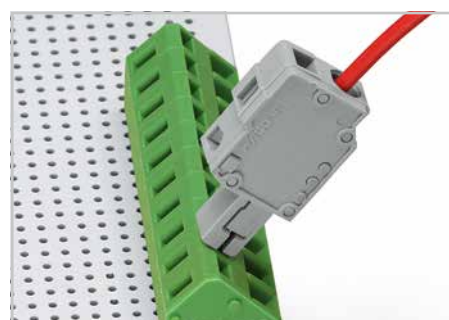

Inserting a test plug module into the operating slot.



Unwired terminal strip with inserted test plug module

Accessories, 231 Series











End plate	Item No.	Pack. Unit	End plate	Item No.	Pack. Unit
	○ 231-100	200 (2 x 100)		● 231-300	200 (2 x 100)

*Observe protection against direct contact for 42 V and higher voltages!

International Certifications – Overview

	Abbreviation for Online Search		Abbreviation for Online Search
 Underwriters Laboratories USA http://www.ul.com	UL	 Danmarks Elektriske Materielkontrol Denmark http://www.demko.dk	DEMKO
 Underwriters Laboratories USA http://www.ul.com	UL	CENELEC CERTIFICATION AGREEMENT	
 Underwriters Laboratories USA http://www.ul.com	cURus	 Danmarks Elektriske Materielkontrol Denmark http://www.cenelec.org	CCA Appr. No. with DK
 Underwriters Laboratories USA http://www.ul.com	cULus	 SETI – FEMKO Sähkötarkastuskeskus Elinspektionscentralen Finland http://www.seti.fi	
 Canadian Standards Association Canada http://www.csa.ca	CSA	 Sähkötarkastuskeskus Elinspektionscentralen Finland http://www.fimko.com	FIMKO
 VDE-Gutachten mit Fertigungsüberwachung Germany http://www.vde.de/vde/html/e/home.htm	VDE	SABS South African Bureau of Standards South Africa http://www.sabs.co.za	SABS
 VDE – Deutscher Verband für Elektrotechnik Germany http://www.vde.de		 RosTest Russia http://www.rostest.ru	ROSTEST
VDE VDE – Prüfbericht Germany		 Departamentul Moldovastandard Moldavia http://www.moldova.md/ro/government/oll/D_STAND/en/strcent2.htm	CSM
 Österreichischer Verband für Elektrotechnik Austria http://www.ove.at	ÖVE	 Certificate of Registration Great Britain http://www.astacertification.com	ASTA
 Schweizerischer Elektrotechnischer Verein Switzerland http://www.sev.ch/	SEV	 Rheinisch-Westfälischer Technischer Überwachungsverein e.V. Germany http://www.rwtuv.de	RWTÜV
 N.V. tot Keuring van Elektrotechnische Materialen Netherlands http://www.kema.nl	KEMA	 Elektrotechnick ý v ýskumn ý a projektov ý ústav Czech Republic http://www.ezu.cz	EZU
CENELEC CERTIFICATION AGREEMENT CCA N.V. tot Keuring van Elektrotechnische Materialen Netherlands http://www.cenelec.org	CCA Appr. No. with NL	 Stowarzyszenie Elektrykow Polskich Poland http://www.bbj.pl	BBJ
 Norges Elektriske Materialkontroll Norway http://express.nemko.com	NEMKO	 Stowarzyszenie Elektrykow Polskich Poland http://www.sep.com.pl	SEP
 Svenska Elektriska Materielkontrollanstalten AB Sweden http://www.semko.com	SEMKO		

For complete, up-to-date approval information, visit www.wago.com.

	Abbreviation for Online Search		Abbreviation for Online Search
CNET	CNET		BKI
LCIE	LCIE	CB	CB
	FTZU	CB	CB
			ENEC
Marine Approvals		Ex Approvals	
	GL		PTB
BV	BV		cURus-EX
	LR		KEMA-EX
	DNV	GOSENERGO-Ex	GOSENERGO-EX
	RMR		FTZU
	PRS		BKI-EX
	KR		
ABS	ABS		

Current-Carrying Capacity Curves Fuse Terminal Blocks for Mini-Automotive, Blade-Style Fuses

Higher ambient temperatures (T_{amb}) place additional strain on fuse cartridges. Therefore, a reduced rated current according to the following diagrams and tables (see factor F_T) should be accounted for in such applications:

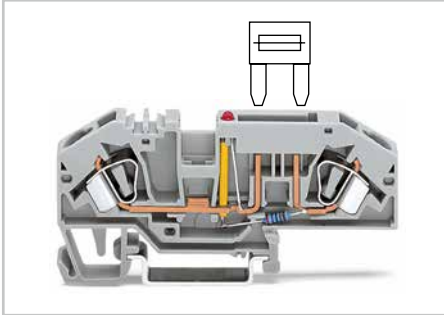

Information from the mini-automotive, blade-type fuse manufacturers

Derating $T_{amb} / ^\circ\text{C}$	%	F_T
- 25	14	0.877
- 20	13	0.885
- 15	12	0.893
- 10	11	0.901
- 5	10	0.909
0	9	0.917
5	8	0.926
10	6	0.943
15	4	0.962
20	2	0.980
23	0	1.000
30	- 2	1.020
35	- 4	1.042
40	- 6	1.064
45	- 8	1.087
50	- 10	1.111
55	- 13	1.149
60	- 16	1.190
65	- 19	1.235
70	- 22	1.282

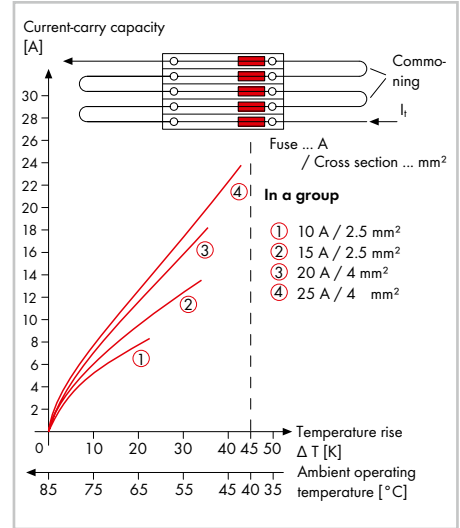
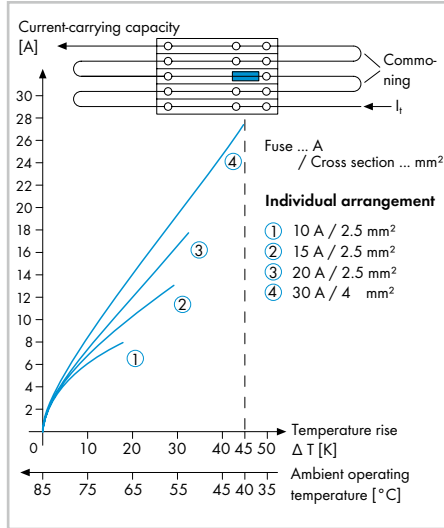

Current-Carrying Capacity Curves for 1-Conductor/1-Pin and 2-Pin Carrier Terminal Blocks and 1-Conductor Female Plugs X-COM®-SYSTEM



1-Conductor/1-Pin
Carrier Terminal Block: 769-176
Conductor size: 4 mm² (12 AWG)

1-Conductor Female Plugs: 769-102 ... 769-115
Conductor size: 4 mm² (12 AWG)
Conductor loop length: 1 m

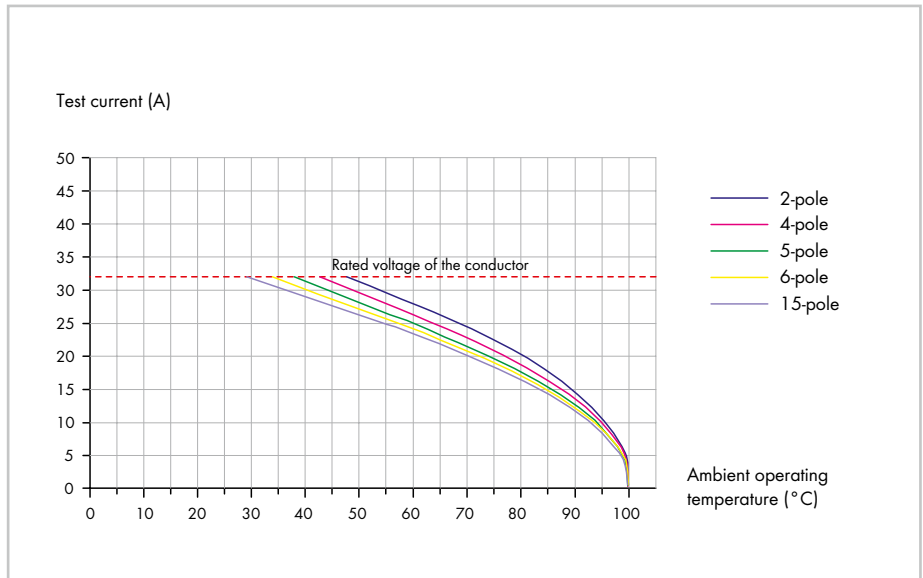

Current-Carrying Capacity Curves for Headers/Connectors with CAGE CLAMP® MULTI CONNECTION SYSTEM (MCS) – MIDI

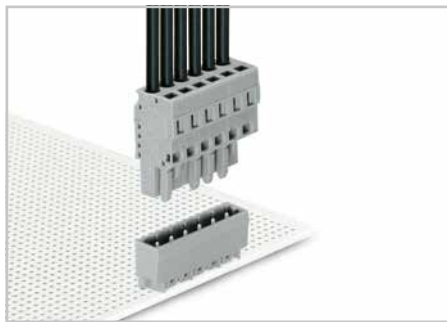

Male Headers with Solder Pins	231-132/001-000 ...
1 mm x 1 mm:	231-154/001-000
1.2 mm x 1.2 mm:	231-162/001-000 ...
	231-184/001-000
Female Connectors:	231-102/026-000 ...
	231-124/026-000
Conductor size (2.5 mm ² "f-st"):	PCB side commoned with 2.5 mm ²
Conductor loop length:	1 m

Additional current-carrying capacity curves upon request.

Male Headers with Straight Solder Pins: 1 mm x 1 mm/1.2 mm x 1.2 mm MIDI
Pin Spacing: 5 mm, 5.08 mm, 7.5 mm and 7.62 mm

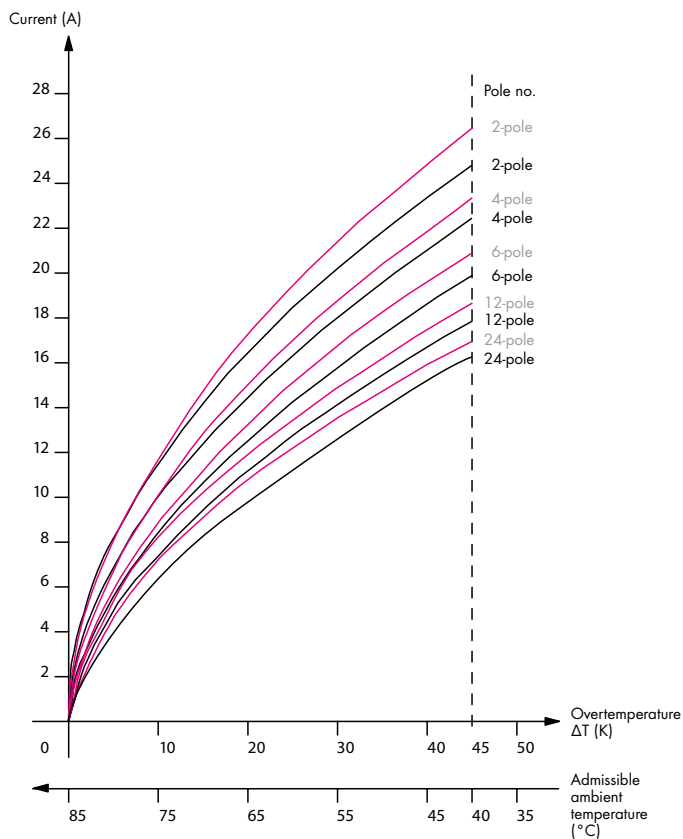

Determining Maximum Load

Explanation using the following example:

What load (amps) can a 6-pole connector assembly handle when subjected to an ambient operating temperature of 55 $^{\circ}\text{C}$?

- 1.) On the bottom axis (x-coordinate = temperature), select the ambient operating temperature for the connector assembly (here 55 $^{\circ}\text{C}$).
- 2.) For this temperature, draw a vertical line up to the curve corresponding to the number of poles (here 6-pole).
- 3.) From the point of intersection, draw a line horizontally to the intersection with the y-axis and read the value of the current.

In this example, all poles of the 6-pole connector assembly can be simultaneously loaded with 4.8 amps at a 55 $^{\circ}\text{C}$ ambient operating temperature.

Example

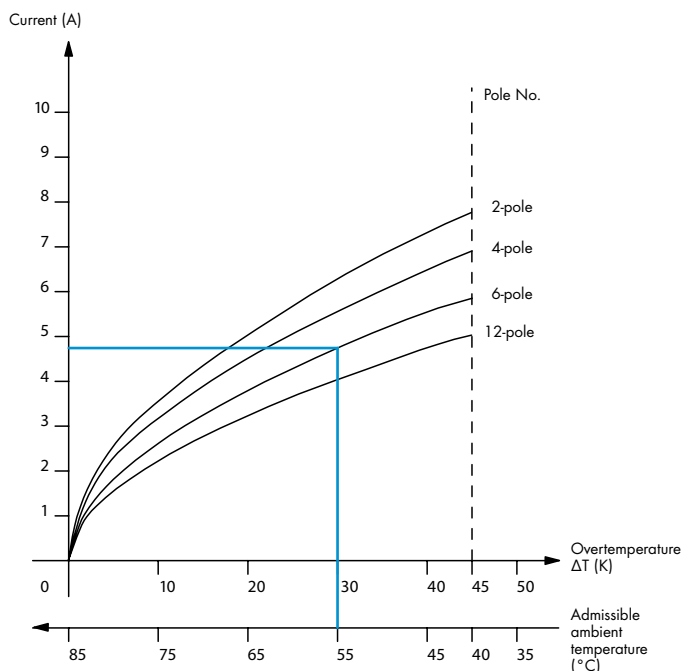

Tests and Testing Procedures per IEC/EN Standards

Electrical Tests

- Insulation Parameters per IEC/EN 60664-1

Table F.4 – Creepage Distances to Avoid Failure due to Tracking
DIN EN 60664-1/VDE 0110, Part 1

Voltage ¹⁾ rms V	Minimum Creepage Distances								
	Printed Circuits		Pollution Degree						
	Pollution Degree		Pollution Degree						
	1 All Material Groups	2 All Material Groups except IIIb	1 All Material Groups	2 Material Group I	2 Material Group II	2 Material Group III	3 Material Group I	3 Material Group II	3 Material Group III ²⁾
mm	mm	mm	mm	mm	mm	mm	mm	mm	
10	0.025	0.040	0.080	0.400	0.400	0.400	1.000	1.000	1.000
12.5	0.025	0.040	0.090	0.420	0.420	0.420	1.050	1.050	1.050
16	0.025	0.040	0.100	0.450	0.450	0.450	1.100	1.100	1.100
20	0.025	0.040	0.110	0.480	0.480	0.480	1.200	1.200	1.200
25	0.025	0.040	0.125	0.500	0.500	0.500	1.250	1.250	1.250
32	0.025	0.040	0.14	0.53	0.53	0.53	1.30	1.30	1.30
40	0.025	0.040	0.16	0.56	0.80	1.10	1.40	1.60	1.80
50	0.025	0.040	0.18	0.60	0.85	1.20	1.50	1.70	1.90
63	0.040	0.063	0.20	0.63	0.90	1.25	1.60	1.80	2.00
80	0.063	0.100	0.22	0.67	0.95	1.30	1.70	1.90	2.10
100	0.100	0.160	0.25	0.71	1.00	1.40	1.80	2.00	2.20
125	0.160	0.250	0.28	0.75	1.05	1.50	1.90	2.10	2.40
160	0.250	0.400	0.32	0.80	1.10	1.60	2.00	2.20	2.50
200	0.400	0.630	0.42	1.00	1.40	2.00	2.50	2.80	3.20
250	0.560	1.00	0.56	1.25	1.80	2.50	3.20	3.60	4.00
320	0.75	1.60	0.75	1.60	2.20	3.20	4.00	4.50	5.00
400	1.0	2.0	1.0	2.0	2.8	4.0	5.0	5.6	6.3
500	1.3	2.5	1.3	2.5	3.6	5.0	6.3	7.1	8.0
630	1.8	3.2	1.8	3.2	4.5	6.3	8.0	9.0	10.0
800	2.4	4.0	2.4	4.0	5.6	8.0	10.0	11.0	12.5
1,000	3.2	5.0	3.2	5.0	7.1	10.0	12.5	14.0	16.0
1,250			4.2	6.3	9.0	12.5	16.0	18.0	20.0
1,600			5.6	8.0	11.0	16.0	20.0	22.0	25.0
2,000			7.5	10.0	14.0	20.0	25.0	28.0	32.0
2,500			10.0	12.5	18.0	25.0	32.0	36.0	40.0
3,200			12.5	16.0	22.0	32.0	40.0	45.0	50.0
4,000			16.0	20.0	28.0	40.0	50.0	56.0	63.0
5,000			20.0	25.0	36.0	50.0	63.0	71.0	80.0
6,300			25.0	32.0	45.0	63.0	80.0	90.0	100.0
8,000			32.0	40.0	56.0	80.0	100.0	110.0	125.0
10,000			40.0	50.0	71.0	100.0	125.0	140.0	160.0
12,500			50.0 ³⁾	63.0 ³⁾	90.0 ³⁾	125.0 ³⁾			
16,000			63.0 ³⁾	80.0 ³⁾	110.0 ³⁾	160.0 ³⁾			
20,000			80.0 ³⁾	100.0 ³⁾	140.0 ³⁾	200.0 ³⁾			
25,000			100.0 ³⁾	125.0 ³⁾	180.0 ³⁾	250.0 ³⁾			
32,000			125.0 ³⁾	160.0 ³⁾	220.0 ³⁾	320.0 ³⁾			
40,000			160.0 ³⁾	200.0 ³⁾	280.0 ³⁾	400.0 ³⁾			
50,000			200.0 ³⁾	250.0 ³⁾	360.0 ³⁾	500.0 ³⁾			
63,000			250.0 ³⁾	320.0 ³⁾	450.0 ³⁾	600.0 ³⁾			

¹⁾ This voltage is for:
 – functional insulation: the working voltage
 – basic and supplementary insulation of the circuit energized directly from the mains (see 4.3.2.2.1): for the voltage rationalized through Table F.3a or F.3b, based on the rated voltage of the equipment, or the rated insulation voltage
 – basic and supplementary insulation of systems, equipment and internal circuits not energized directly from the mains (see 4.3.2.2.2): the highest rms voltage which can occur in the system, equipment or internal circuit when supplied at rated voltage and under the most taxing combination of operation conditions within equipment rating



²⁾ Material group IIIb is not recommended for applications in pollution degree 3 above 630 V.

³⁾ Provisional data based on extrapolation. Technical committees with other information based on experience may use their dimensions.

⁴⁾ The values in brackets shall only be applied for reducing creepage distances if a rib is used (see 5.2.5).

The high degree of accuracy of the creepage distances given in the table does not imply that the measuring accuracy must be of the same quality.

Technical Information and Abbreviations

0.25 ... 2.5 (4) mm² ① 800 V/8 kV/3 I_N 24 A Terminal block width: 5.2 mm / 0.205 in.  10 ... 12 mm / 0.43 in. ② Approvals	22 ... 12 AWG 600 V, 20 A ㉗ 600 V, 20 A ㉘	Pin spacing: 5 mm / 0.197 in. 0.5 ... 2.5 mm² "s+f-st" 20 ... 12 AWG "s+f-st" 250 V/4 kV/3, 16 A 300 V, 10 A 500 V/4 kV/2, 16 A	 10 ... 11 mm / 0.41 in. ② Approvals
---	--	---	--

- ① Conductor range: 0.25 ... 4 mm² "s+f-st";
 Push-in termination: 0.75 ... 4 mm² "s" and 0.75 ... 2.5 mm² "insulated ferrule, 12 mm"
 (Length of ferrule is only related to the metallic part.)

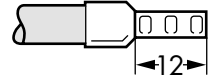

Pin spacing 5 mm / 0.197 in.: Pin spacing of the terminal block/connector
 (e.g., PCB terminal blocks and *MULTI CONNECTION SYSTEM*)

0.25 ... 2.5 (4) mm² / 22 ... 12 AWG: Conductor range (min. ... max.),
 ferrules reduce cross-section to 2.5 mm² (see ①)

800 V/250 V/500 V: Rated voltage (see Full Line Catalog)

8 kV/4 kV: Rated impulse voltage (see Full Line Catalog)

3/2: Degree of pollution (see Full Line Catalog)

I_N 24 A/16 A: Maximum current

600 V, 20 A ㉗: Voltage and current values per UL approval

600 V, 20 A ㉘: Voltage and current values per CSA approval

300 V, 10 A: Voltage and current values per applied UL and CSA approvals

Terminal block width 5.2 mm/0.205 in.: Width of modular terminal blocks (e.g., rail-mounted terminal blocks)

 **10 ... 12 mm / 0.43 in.:** Strip length (fine-stranded conductor)

 **10 ... 11 mm / 0.41 in.:** Strip length (solid conductor)

② **Approvals** (Current approvals are available online at: www.wago.com)

Abbreviations

"s": Solid conductor	AWG: American Wire Gauge
"st": Stranded conductor	I_N 32 A: Nominal current of 32 A (e.g., for jumpers)
"f-st": Fine-stranded conductor	WCB: WAGO Combi Marking System
"s+f-st": Solid and fine-stranded conductors	WMB: WAGO Multi Marking System
"sol.": Solid conductor	WSB: WAGO Quick Marking System
"f-st": Fine-stranded conductor	

Material Specifications

Insulating Materials:

WAGO primarily uses polyamide (PA 6.6 and PA 4.6) as carriers of current-conducting parts and polycarbonate (PC) as insulating material. For more than 40 years, these materials have proven themselves in WAGO products and all are approved by certified, third-party agencies.

Contact Materials:

Hard and extra-hard electrolytic copper (ECu), as well as extra-hard copper alloys are the standard materials used for the current-carrying parts of all WAGO products. This material combines excellent conductivity and good chemical resistance without the risk of stress-induced cracking.

Contact Plating:

The special tin layer, which is the standard layer for all current-carrying parts in WAGO products, ensures perfect long-term protection against corrosive substances. Furthermore, these layers provide a gas-tight contact that ensures a durable transition resistance.

Clamping Spring Material:

Every WAGO clamping spring is made of high-quality, accurately tested austenitic chrome nickel steel (CrNi) with high tensile strength, which boasts proven corrosion resistance through long-term usage. It is resistant to sea spray, city pollutants and industrial emissions (e.g., sulfur dioxide, hydrogen sulfide).

PRODUCT INDEX

A	Page	D	Page	G	Page
Actuator terminal blocks, Classic	77	Rail-mounted terminal blocks, Classic	75	Ground conductor terminal blocks, Classic, FE	71
Actuator terminal blocks, TOPJOB® S	65	Rail-mounted terminal blocks with test slot, Classic	81	Classic, SE	74
Adjacent jumpers for Classic rail-mounted terminal blocks	72	Rail-mounted terminal blocks, TOPJOB® S	45	TOPJOB® S	25
Analog output I/O modules	167	Displays, see e!DISPLAY and PERSPECTO®	150	Group marker carriers	249
Analog input I/O modules	165	Distribution supply terminal blocks, TOPJOB® S	43	H	
Approvals	264	Distribution terminal blocks, Classic	72	High-current, rail-mounted terminal blocks	32
AS-Interface Master	171	Double-deck terminal strips for PCBs	129	I	
Automation technology	144	Double-deck carrier terminal blocks, TOPJOB® S	58	IEC 60870 Configurator	149
B		carrier terminal blocks, X-COM®S-SYSTEM	67	IEC 61850 Configurator	149
BACnet Configurator	149	diode terminal blocks, TOPJOB® S	61	Intelligent current sensors	228
Banana plugs	262	double-disconnect terminal blocks, TOPJOB® S	58	Interface adapter	209
Building pluggable connectors, see WINSTA®	134	fuse terminal blocks, TOPJOB® S	58	cables	232
Buffer modules	199	rail-mounted terminal blocks, Classic	73	configuration software	203
Bus modules, see WAGO-I/O-SYSTEM	152	rail-mounted terminal blocks, TOPJOB® S	36	modules	234
Busbars	41	Junction box terminal blocks	105	Intrinsically safe Ex i modules	175
Busbar terminal blocks for potential distribution	91	E		IO-Link Master	171
C		e!COCKPIT Software	146	Isolation amplifiers, see JUMPFLEX®	200
Cable cutter	256	e!DISPLAYS	150	J	
Cable strippers	258	Electric motor wiring (quadruple-deck) rail-mounted terminal blocks, Classic	73	Jumpers for rail-mounted terminal blocks	
CAGE CLAMP®	14	Electric motor wiring (quadruple-deck) rail-mounted terminal blocks, TOPJOB® S	39	Adjacent jumpers, Classic	72
Carrier rails	251	Empty component plug housing for terminal blocks for pluggable modules	236	Push-in type jumper bars, TOPJOB® S	25
Carrier terminal blocks, Classic	71	Empty housings	237	Push-in type wire jumpers	26
Carrier terminal blocks, TOPJOB® S	48	End stops	249	Staggered jumpers	72
Carrier terminal blocks, X-COM®-SYSTEM	67	Energy measurement	224	Step-down jumpers	29, 75
Chassis-mount terminal strips	97	Engineering software	146	JUMPFLEX®	
CODESYS, see e!COCKPIT Software and WAGO I/O-PRO	146	EPSITRON® Power Supplies		Current signal conditioner	202
Coding keys for MCS	125	Capacitive buffer modules	199	Frequency signal conditioners	204
Coding pins for X-COM®S-SYSTEM	67	CLASSIC Power	190	Isolation amplifiers	200
Collective carriers for jumpers	250	COMPACT Power	189	Potentiometer signal conditioner	204
Common potential terminal blocks	89	DC/DC converters	194	Temperature signal conditioners	202
Communication modules for I/O-System	171	ECO Power	188	Threshold value switches	204
Companies and representatives	290	Electronic circuit breakers	195	Junction box connectors	107
Component plugs, empty	218	PRO Power	192	Junction box connectors, COMPACT	106
Connection cables for SPEEDWAY	182	Redundancy modules	199	Junction box connectors, MICRO	105
Connection technologies	14	Uninterruptible power supply	198	L	
Control panels	151	ETHERNET® industrial switches	184	Labels	247
Controllers		Ex i modules for I/O-System	175	LED terminal blocks, TOPJOB® S	60
PFC100	156	F		Lighting terminal blocks	101
PFC200	156	Female connectors		Lighting terminal blocks, Linect®	103
Programmable fieldbus controllers	157	picoMAX®	111	Lighting connectors	108
Covers for rail-mounted terminal blocks	250	MULTI CONNECTION SYSTEM (MCS)	115	Luminaire disconnect connectors	108
Crimping tools	258	X-COM®-SYSTEM	84	M	
Current-carrying capacity curves	266	X-COM® S-SYSTEM	67	Male headers for PCBs, see MULTI CONNECTION SYSTEM	115
Current flow monitoring modules	223	Ferrules	259	Marking accessories	244
Current sensors	228	Fieldbus connectors	178	Marking sleeves	246
Current transformer terminal blocks, TOPJOB® S	56	Fieldbus couplers for I/O-System	159	Matrix patchboards	87
D		Finger guards	31	Measurement devices	260
DALI Configurator	149	Function modules for I/O-System	169	Memory cards	150
DC/DC converters	194	Fuse plugs	79	Miniature terminal blocks	93
Digital output I/O modules	163	Fuse terminal blocks		Modular empty housings	237
Digital input I/O modules	161	for cylindrical fuses, Classic	79	Modular terminal blocks	
DIN-rail-mount carriers with a miniature switching relay	216	for mini-automotive blade-style fuses, Classic	79	FE	95
DIN-rail-mount PCB carriers	235	for mini-automotive blade-style fuses, TOPJOB® S	49	SE	93
Diode terminal blocks, TOPJOB® S	60	Rail-mounted terminal blocks, Classic	75	MULTI CONNECTION SYSTEM	
Disconnect plugs	45	Rail-mounted terminal blocks, TOPJOB® S	45	MAXI - 100 % protected against mismatching	
Disconnect terminal blocks for test and measurement		with pivoting fuse holder, Classic	79	7.62 mm pin spacing	123
FE = Front-entry wiring SE = Side-entry wiring		G		MICRO - 100 % protected against mismatching	
		Ground conductor disconnect terminal blocks, TOPJOB® S	49	2.5 mm pin spacing	115
				MIDI - 100 % protected against mismatching	
				5 mm/7.5 mm pin spacing	118
				MIDI Classic	

M	Page	R	Page	T	Page
5 mm/5.08 mm pin spacing	119	Relay modules with force-guided contacts	216	Distribution supply terminal blocks	43
7.5 mm/7.62 mm pin spacing	122	Relay sockets	216	Double-deck carrier terminal blocks	58
MINI - 100 % protected against mismatching		Relay sockets		Double-deck diode terminal blocks	61
3.5 mm pin spacing	116	with an industrial relay	214	Double-deck fuse terminal blocks	58
3.81 mm pin spacing	117	with miniature switching relay	208, 212	Double-deck rail-mounted terminal blocks	36
MINI HD, 3.5 mm pin spacing	115	with solid-state relay	208, 213	Double-disconnect terminal blocks	59
MINI SL, 3.5 mm pin spacing	115	Rogowski coils	229	Electric motor wiring (quadruple-deck) rail-mounted terminal blocks	39
Multilevel installation terminal blocks, TOPJOB® S41		S		Fuse terminal blocks	45
Multilevel terminal blocks, see "Double-deck and triple-deck terminal blocks"		Safety modules	174	Ground conductor terminal blocks	25
N		Safety relays, see "Relay modules with force-guided contacts"	216	LED terminal blocks	60
N-conductor disconnect terminal blocks, TOPJOB® S 42		Segment modules for I/O-System	173	Multilevel installation terminal blocks	41
O		Sensor/actuator boxes, IP67	183	N-conductor disconnect terminal blocks	42
Operating tools	252	Sensor terminal blocks		Power distribution disconnect terminal blocks	42
Optocoupler modules (rail-mounted terminal blocks)	211	Classic	77	Sensor terminal blocks	63
Optocoupler modules (pluggable)	221	TOPJOB® S	63	Triple-deck rail-mounted terminal blocks	38
P		Service connectors	108	Through terminal blocks	25
Passive distribution boxes, IP67	183	Shield clamping saddles	185	Shield terminal blocks	26
PCB terminal blocks and PCB terminal strips	128	Shield terminal blocks, TOPJOB® S	26	Voltage transformer terminal blocks	56
PE terminal blocks, see "Ground conductor terminal blocks"	25	Signal conditioners, see JUMPFLEX®	204	Transformer terminal blocks	98
PERSPECTO® Web and Control Panels	151	Splicing connectors, COMPACT	109	Transformer terminal blocks, Classic	83
PFC100 Controller	156	Staggered jumpers		Transformer terminal blocks, TOPJOB® S	56
PFC200 Controller	156	Classic	72	Triple-deck	
picoMAX® Pluggable Connectors	111	TOPJOB® S	27	diode terminal blocks, TOPJOB® S	61
picoMAX® eCOM Pluggable Connectors	113	smartDESIGNER	239	rail-mounted terminal blocks, Classic	73
Plotters	243	SMD PCB terminal blocks	133	rail-mounted terminal blocks, TOPJOB® S	38
Plug-in current transformers	226, 228	Snap-in sockets/plugs (WINSTA®)	139	Twin ferrules	259
Pluggable connectors, see MULTI CONNECTION SYSTEM	115	Specialty modules for carrier terminal blocks	223	V	
Pluggable optocouplers		SPEEDWAY, IP67 I/O-System	181	Vertical jumpers, TOPJOB® S	36
for carrier terminal blocks	221	Split-core current transformers	227	Voltage transformer terminal blocks, TOPJOB® S	56
Pluggable PCB connectors, see MULTI CONNECTION SYSTEM	115	Step-down jumpers		W	
Pluggable relay modules		Classic	29	WAGO-I/O-CHECK	148
for carrier terminal blocks	218	TOPJOB® S	75	WAGO-I/O-PRO	148
Pluggable timer relay modules		Stickers for operating instructions	255	WAGO-I/O-SYSTEM	
for carrier terminal blocks	222	Stripping tools	257	Analog output I/O modules	167
POWER CAGE CLAMP	15	Subsidiaries and representatives	290	Analog input I/O modules	165
Power distribution disconnect terminal blocks, TOPJOB® S42		Supply modules for I/O system	173	Communication modules	171
Power supplies, see EPSITRON®	188	Surge suppression modules	222	Digital output I/O modules	163
Power taps for high-current terminal blocks	229	Switchgear cabinet drawer	250	Digital input I/O modules	161
Potential multiplication modules		System wiring	232	ETHERNET® industrial switches	184
for I/O-System	234	T		Ex i modules	175
Printers, thermal transfer printers	243	Technical information	269	Fieldbus couplers	159
Programmable fieldbus controllers	157	Technology modules for I/O-System	169	Function modules	169
Programming software for WAGO Controllers, see e!COCKPIT and WAGO-I/O-PRO		Terminal blocks for matrix patching	89	SPEEDWAY	181
Protective warning marker	25	Terminal blocks for pluggable modules, Classic	219	Stepper modules	169
PUSH WIRE®	15	Terminal strips (modular terminal blocks)		Supply modules	173
Push-in CAGE CLAMP®	14	FE	95	XTR	176
Push-in type jumper bars, TOPJOB® S	25	SE	93	WAGO WebVisu App	149
Push-in type wire jumpers, TOPJOB® S	26	Test devices	260	Web panels	150
Q		Test pin	262	WINSTA®	
Quadruple-deck, rail-mounted terminal blocks (for fast electric motor wiring), TOPJOB® S 39		Test plug modules	263	IDC	137
R		Test plugs	262	KNX	137
Radio technology	179	Thermal transfer printers	243	MAXI	136
Rail-mounted terminal blocks		THR terminal blocks	128	MIDI	140
with a miniature switching relay	210	Threshold value switches	204	MINI	138
with an optocoupler	211	Through terminal blocks, Classic, FE	71	X	
Redundancy modules	199	Through terminal blocks, Classic, SE	74	X-COM®-SYSTEM	84
Relay modules in a DIN-rail-mount enclosure	215	Through terminal blocks, TOPJOB® S	25	X-COM®S-SYSTEM	
		Timer relays	209	Carrier terminal blocks	68
		TOPJOB® S		Double-deck carrier terminal blocks	68
		Actuator terminal blocks	65	X-COM®S-SYSTEM MINI	
		Carrier terminal blocks	48	Carrier terminal blocks	67
		Current transformer terminal blocks	56	Double-deck carrier terminal blocks	67
		Diode terminal blocks	60	XTR	177
		Diode terminal blocks	61		
		Disconnect terminal blocks for test and measurement	45		

Item No.	Page	Item No.	Page	Item No.	Page	Item No.	Page
218 Series		231 Series		231 Series		231 Series	
218-502	128	231-202/037-000	122	231-632	120	231-2202/037-000	122
218-524	128	231-216/037-000	122	231-654	120	231-2212/037-000	122
218-502/000-604	128	231-231	254	231-632/018-000	120	231-2302/026-000	120
		231-232/001-000	122				
218-507/000-604	128			231-654/018-000	120	231-2316/026-000	120
221 Series		231-346/001-000	122	231-632/019-000	120	231-2302/037-000	120
		231-232/001-000/105-604	122				
				231-654/019-000	120	231-2316/037-000	120
221-412	109	231-242/001-000/105-604	122	231-632/109-000	120	231-2302/107-000	120
221-413	109	231-262/001-000	122				
221-415	109			231-646/109-000	120	231-2316/107-000	120
221-500	109	231-276/001-000	122	231-632/114-000	120	231-2702/026-000	123
222 Series		231-262/001-000/105-604	122				
				231-654/114-000	120	231-2712/026-000	123
		231-372/001-000/105-604	122	231-632/129-000	120	232 Series	
222-412	109	231-291	254			232-102/026-000	119
222-413	109			231-646/129-000	120		
222-415	109	231-300	263	231-661	124	232-124/026-000	119
222-500	109	231-302/008-000	120	231-662	124	232-132	119
222-505	109			231-668	124		
222-510	109	231-324/008-000	120	231-669	124	232-154	119
224 Series		231-302/026-000	120	231-670	125	232-132/005-000	119
				231-671	125		
224-101	108	231-324/026-000	120	231-672	125	232-150/005-000	119
224-104	108	231-302/031-000	120	231-673	125	232-132/031-000	119
224-112	108			231-674	125		
224-114	108	231-324/031-000	120	231-675	125	232-154/031-000	119
224-201	108	231-302/037-000	120			232-132/039-000	119
231 Series				231-702/008-000	123		
		231-324/037-000	120			232-154/039-000	119
		231-302/107-000	120	231-712/008-000	123	232-162	120
				231-702/026-000	123		
231-100	263	231-316/107-000	120			232-184	120
231-102/008-000	119	231-332/001-000	120	231-712/026-000	123	232-162/031-000	120
				231-702/031-000	123		
231-124/008-000	119	231-354/001-000	120			232-184/031-000	120
231-102/026-000	119	231-332/108-000	120	231-712/031-000	123	232-162/039-000	120
				231-702/037-000	123		
231-124/026-000	119	231-346/108-000	120			232-184/039-000	120
231-102/031-000	119	231-362/001-000	120	231-712/037-000	123		
				231-732/001-000	123	232-202/026-000	119
231-124/031-000	119	231-384/001-000	120				
231-102/037-000	119	231-391	124	231-742/001-000	123	232-224/026-000	119
				231-762/001-000	123	232-232	119
231-124/037-000	119	231-426	263				
231-125	263	231-432/001-000	119	231-772/001-000	123	232-254	119
231-126	263			231-832/001-000	122	232-232/031-000	119
231-127	263	231-454/001-000	119				
231-128	263	231-432/001-000/105-604	119	231-846/001-000	122	232-254/031-000	119
231-129	125			231-832/001-000/105-604	122		
231-130	125	231-442/001-000/105-604	119			232-232/039-000	119
231-131	254	231-432/040-000	119	231-842/001-000/105-604	122		
231-132/001-000	119			231-862/001-000	122	232-254/039-000	119
		231-444/040-000	119				
231-154/001-000	119	231-455	263	231-876/001-000	122	232-262	120
231-132/001-000/105-604	119	231-456	263	231-862/001-000/105-604	122		
		231-500	124			232-284	120
231-142/001-000/105-604	119	231-532/001-000	120	231-872/001-000/105-604	122	232-262/031-000	120
231-132/040-000	119						
		231-554/001-000	120	231-902	124	232-284/031-000	120
231-144/040-000	119	231-532/108-000	120	231-903	124	232-262/039-000	120
231-155	263			231-905	124		
231-159	254	231-546/108-000	120	231-907	124	232-284/039-000	120
231-160	125	231-562/001-000	120	231-910	124		
231-161	263			231-932/001-000	123	232-302/026-000	120
231-162/001-000	267	231-584/001-000	120				
231-162/003-000	119			231-942/001-000	123	232-324/026-000	120
		231-602	119	231-962/001-000	123	232-332	119
231-180/003-000	119						
231-193	124	231-624	119	231-972/001-000	123	232-346	119
231-195	124	231-602/018-000	119	231-2102/026-000	119	232-362	120
231-202/008-000	122						
		231-624/018-000	119	231-2116/026-000	119	232-376	120
231-216/008-000	122	231-602/019-000	119	231-2102/037-000	119	232-402/026-000	120
231-202/026-000	122						
		231-624/019-000	119	231-2116/037-000	119	232-424/026-000	120
231-216/026-000	122	231-602/114-000	119	231-2116/026-000	119	232-502/007-000	119
231-202/031-000	122			231-2202/026-000	122		
		231-624/114-000	119			232-524/007-000	119
231-216/031-000	122			231-2212/026-000	122		

Item Number Index

Item No.	Page	Item No.	Page	Item No.	Page	Item No.	Page
232 Series		233 Series		248 Series		254 Series	
232-532/007-000	120	233-502	128	248-501/000-023	178	254-451	129
				248-501/000-024	178		
232-554/007-000	120	233-524	128	248-502	245	254-498	129
232-562/007-000	122	234 Series		248-503	245	254-551	130
		234-202	128	248-504	245		
232-572/007-000	122			248-505	245	254-574	130
232-582/007-000	123	234-224	128	248-506	245	254-651	131
				248-507	245		
232-592/007-000	123	234-502	128	248-508	245	254-674	131
232-602	124			248-509	245	255 Series	
		234-524	128	248-544	245	255-401	129
232-610	124	235 Series		248-545	245		
232-612	124	235-101	128	248-565	245	255-448	129
232-632	124			248-566	245	255-501	130
		235-148	128	249 Series			
232-640	124	235-101/330-000	128	249-116	249	255-524	130
232-642	124			249-117	249	255-601	131
232-662	124	235-148/330-000	128	249-118	249		
		235-401	129	249-119	249	255-624	131
232-665	124			249-120	249	256 Series	
232-667	124	235-448	129	249-130	107	256-401	129
232-682	124			249-135	93		
		235-501	130	249-136	93	256-448	129
232-685	124			249-137	93	256-501	130
232-687	124	235-524	130	249-138	93		
		235-501/331-000	130	249-139	93	256-524	130
232-732	122			249-140	93	256-601	131
		235-524/331-000	130	249-197	249		
232-746	122	235-801	131	250 Series		256-624	131
232-732/031-000	122			250-102	128	257 Series	
		235-824	131			257-401	129
232-746/031-000	122	235-801/331-000	131	250-124	128		
232-732/039-000	122			250-202/353-604	128	257-448	129
		235-824/331-000	131			257-501	130
232-746/039-000	122	236 Series		250-208/353-604	128		
232-732/047-000	122	236-101	129	250-402	128	257-524	130
				250-424	128	257-601	131
232-746/047-000	122	236-148	129	250-402/350-604	128		
232-762	123	236-201	130			257-624	131
				250-408/350-604	128	258 Series	
232-772	123	236-224	130	250-502	129	258-200	243
232-762/031-000	123	236-301	131			258-326	243
				250-516	129	258-327	243
232-772/031-000	123	236-324	131	250-602	130	258-328	243
232-762/039-000	123	236-332	254			258-361	243
		236-335	254	250-612	130	258-362	243
232-772/039-000	123	236-402/334-604	129	250-702	129	258-363	243
						258-364	243
232-832	122	236-406/334-604	129	250-724	129	258-368	243
		243 Series		250-1402	128	258-369	243
232-846	122	243-110	105			258-370	246
232-832/031-000	122	243-112	105	250-1424	128	258-371	248
		243-113	105	251 Series		258-383	243
232-846/031-000	122	243-144	105	251-102	128		
232-832/039-000	122	243-204	105			258-450	243
		243-208	105	251-107	128	258-452	243
232-846/039-000	122	243-304	105	252 Series		258-452/000-002	243
232-832/047-000	122	243-308	105	252-102	132	258-452/000-003	243
		243-504	105			258-452/000-004	243
232-862	123	243-508	105	252-110	132	258-452/000-005	243
		243-742	132	252-152	132	258-452/000-007	243
232-872	123					258-452/000-010	243
232-862/039-000	123	243-748	132	252-160	132	258-454	243
		243-804	105	253 Series		258-455	243
232-872/039-000	123	243-808	105	253-102	129	258-456	243
233 Series		248 Series				258-457	243
233-102	128	248-501	245	253-116	129	258-458/000-002	243
		248-501/000-002	178	254 Series		258-458/000-004	243
233-124	128	248-501/000-005	178	254-500	243	258-5005	243
233-202	128	248-501/000-006	178	258-5006	243	258-5007	243
		248-501/000-007	178	255 Series			
233-224	128	248-501/000-012	178	255-401	129		
233-331	254	248-501/000-017	178				
233-332	254	256 Series		255-448	129		
233-335	254	256-401	129	255-501	130		
233-402	128			255-524	130		
		256-448	129	255-601	131		
233-424	128	256-501	130	255-624	131		
		256-601	131				
		256-624	131				

Item No.	Page	Item No.	Page	Item No.	Page	Item No.	Page
258 Series		264 Series		279 Series		280 Series	
258-5008	243	264-152	95	279-344	71	280-434	252
258-5009	243			279-346	71	280-435	252
258-5010	243	264-162	95	279-402	72	280-436	252
258-5015	243	264-180	95	279-422	72	280-437	252
258-5030	243	264-202	95	279-432	252	280-438	252
260 Series		264-203	95	279-433	252	280-439	252
260-102	93	264-204	95	279-440	252	280-440	252
		264-210	95	279-501	73	280-470	77
260-112	93	264-211	95	279-504	73	280-471	77
260-202	93	264-212	95	279-507	73	280-472	77
		264-225	95	279-508	73	280-492	95
260-212	93	264-230	95	279-509	73		
260-301	93	264-231	95	279-512	73	280-510	73
260-303	93	264-252	95	279-513	73	280-517	73
260-304	93	264-253	95	279-517	73	280-519	73
260-306	93	264-254	95	279-518	73	280-520	73
260-307	93	264-260	95	279-519	73	280-523	73
260-331	93	264-261	95	279-527	73	280-524	73
260-333	93	264-262	95			280-527	73
260-334	93	264-280	95	279-681	71	280-529	73
260-336	93			279-682	71	280-530	73
260-337	93	264-301	95	279-683	71	280-533	73
260-361	93	264-304	95	279-684	71	280-534	73
260-402	93	264-306	95	279-685	71	280-537	73
260-404	93			279-686	71	280-547	73
260-405	93	264-307	95	279-687	71	280-548	73
		264-311	95	279-831	71	280-549	73
261 Series		264-314	95	279-832	71	280-550	73
261-102	93	264-316	95	279-833	71	280-551	73
		264-317	95	279-834	71	280-552	73
261-112	93	264-321	95	279-835	71	280-555	77
261-202	93	264-322	95	279-836	71	280-556	77
		264-324	95	279-837	71	280-557	73
261-212	93	264-326	95			280-558	73
261-301	93	264-327	95	279-901	71	280-560	77
261-303	93	264-331	95	279-902	71	280-560/281-413	77
261-304	93	264-334	95	279-903	71	280-560/281-434	77
261-306	93	264-336	95	279-904	71	280-562	77
261-307	93	264-337	95	279-905	71	280-562/281-411	77
261-331	93	264-341	95	279-906	71	280-562/281-420	77
261-333	93	264-344	95	279-907	71	280-562/281-434	77
261-334	93	264-346	95	279-992	71	280-564	77
261-336	93	264-347	95	279-993	71	280-564/281-483	77
261-337	93	264-351	95	279-994	71	280-564/281-496	77
261-361	93	264-354	95			280-570	77
261-402	93	264-356	95	280 Series		280-570/281-413	77
261-404	93	264-357	95	280-101	74	280-570/281-434	77
261-405	93	264-361	95	280-104	74	280-572	77
		264-363	95	280-107	74	280-572/281-411	77
262 Series		264-364	95	280-301	74	280-572/281-420	77
262-102	93	264-367	95	280-302	74	280-572/281-434	77
		264-370	95	280-303	73	280-574	77
262-112	93	264-371	95	280-304	73	280-574/281-483	77
262-130	93	264-373	95	280-305	73	280-574/281-496	77
262-202	93	264-374	95	280-306	73	280-580	77
				280-308	71	280-580/281-413	77
262-212	93	264-402	95	280-309	71	280-580/281-434	77
262-230	93	264-711	95	280-312	71	280-584	77
262-301	93	264-714	95	280-313	71	280-584/281-483	77
262-304	93	264-716	95	280-314	71	280-584/281-496	77
262-306	93	264-731	95	280-315	71	280-585	77
262-307	93	264-734	95	280-319	77	280-586	77
262-331	93	264-736	95	280-320	77	280-592	77
262-334	93	264-737	95	280-321	77	280-593	77
262-336	93	264-737/999-950	95	280-322	77	280-597	73
262-337	93			280-323	77		
262-361	93	275 Series		280-324	71	280-608	219
262-402	93	275-066	290	280-326	71	280-609	219
		275-736	290	280-340	73	280-610	236
264 Series				280-341	73	280-618	219
264-102	95	279 Series		280-342	73	280-619	219
		279-101	74	280-343	73	280-628	219
264-112	95	279-104	74	280-371	81	280-629	219
264-125	95	279-301	74	280-373	81	280-636	219
264-130	95	279-302	74	280-374	81	280-637	71
264-131	95	279-308	71	280-376	81	280-638	219
		279-308	71			280-639	219
		279-325	71	280-402	72	280-641	71
		279-328	71	280-422	72	280-646	71
		279-339	71	280-432	252	280-650	71
				280-433	252	280-651	71

Item Number Index

Item No.	Page	Item No.	Page	Item No.	Page	Item No.	Page
280 Series		281 Series		282 Series		282 Series	
280-653	71	281-422	72	282-107	74	282-698/281-449	79
280-654	71	281-440	252	282-120	75	282-699	81
280-656	71	281-482	204	282-122	75	282-811	83
280-671	71	281-492	95	282-124	75	282-821	83
280-672	71	281-503	48	282-126	75	282-841	83
280-681	71	281-511	79	282-128	75	282-841/049-000	83
280-684	71	281-512/281-414	79	282-128/281-413	75	282-860	83
280-686	236	281-512/281-417	79	282-128/281-417	75	282-865	83
280-687	71	281-512/281-418	79	282-128/281-418	75	282-866	83
280-762	219	281-512/281-501	79	282-131	75	282-870	83
280-763	219	281-530	73	282-133	75	282-881	56
280-764	219	281-531	73	282-135	75		
280-765	219	281-532	73	282-137	75	282-888	56
				282-138	75	282-901	72
280-801	236	281-610	71	282-139	75	282-902	72
280-802	236	281-611	79	282-140	75	282-904	72
280-803	236	281-611/281-417	79	282-141	75	282-907	72
280-804	236	281-611/281-418	79			282-992	72
280-816	71	281-611/281-541	79	282-301	74	282-993	72
280-830	71	281-611/281-542	79	282-302	74		
280-831	71	281-612	79	282-308	72	283 Series	
280-832	71	281-612/281-417	79	282-311	75	283-101	74
280-833	71	281-612/281-418	79	282-312	75	283-104	74
280-834	71	281-612/281-541	79	282-314	75	283-107	74
280-835	71	281-612/281-542	79	282-315	75	283-301	74
280-837	71	281-613	79	282-325	72	283-302	74
280-868	81	281-613/281-417	79	282-328	72	283-325	72
280-869	81	281-613/281-418	79	282-333	79	283-328	72
280-870	81	281-613/281-541	79	282-334	79	283-350	72
280-871	81	281-613/281-542	79	282-339	72	283-352	72
280-874	81	281-616	79	282-360	83	283-402	72
280-875	81	281-619	73	282-361	83	283-404	34
280-876	81	281-620	73	282-365	83	283-414	75
280-879	81	281-622	79	282-366	83	283-422	72
280-880	81	281-622/281-417	79	282-369	250		
280-881	81	281-622/281-418	79	282-370	83	283-671	72
280-882	81	281-622/281-541	79	282-372	83	283-672	72
280-883	81	281-622/281-542	79	282-373	83	283-674	72
280-884	81	281-623	79	282-374	83	283-677	72
280-885	81	281-623/281-417	79	282-384	83	283-901	72
		281-623/281-418	79	282-385	83	283-902	72
280-901	71	281-623/281-541	79	282-387	83	283-904	72
280-902	71	281-623/281-542	79	282-390	83	283-907	72
280-903	71	281-629	73	282-392	83	283-992	72
280-904	71	281-630	73			283-998	72
280-905	71	281-631	71	282-402	72		
280-906	71	281-637	71	282-422	72	284 Series	
280-907	71	281-651	71	282-424	83	284-101	74
280-916	236	281-652	71	282-432	56	284-104	74
280-946	71	281-653	71	282-432	83	284-107	74
280-992	71	281-654	71			284-301	74
280-993	71	281-657	71	282-440	56	284-302	74
280-994	71	281-663	71	282-432/100-000	56	284-308	72
280-996	71	281-664	71	282-433/100-000	56	284-325	72
280-998	71	281-668	71	282-434/100-000	56	284-328	72
		281-678	71	282-435/011-000	56	284-339	72
281 Series		281-679	71	282-436/301-000	56	284-400	91
281-101	74	281-681	71	282-437/011-000	56	284-402	72
281-104	74	281-684	71	282-437/012-000	56	284-412	72
281-107	74	281-685	71	282-438/300-000	56	284-413	75
281-301	74	281-686	71	282-438/301-000	56	284-414	75
281-302	74	281-687	71	282-439/011-000	56	284-422	72
281-309	79			282-442	83		
281-311	79	281-816	71			284-621	72
281-312	71	281-901	71	282-446	83	284-624	72
281-313	71	281-902	71			284-681	72
281-324	71	281-903	71	282-638	81	284-682	72
281-326	71	281-904	71	282-639	81	284-684	72
281-328	71	281-905	71	282-640	81	284-687	72
281-329	71	281-906	71	282-641	81	284-901	72
281-334	71	281-907	71	282-681	72	284-902	72
281-335	71	281-916	71	282-682	72	284-904	72
281-340	73	281-992	71	282-684	72	284-907	72
281-341	73	281-993	71	282-687	72	284-992	72
281-342	73	281-994	71	282-694	81	284-993	72
281-343	73	281-998	71	282-695	81		
281-365	73			282-696	79		
281-366	73	282 Series		282-697	81		
281-402	72	282-101	74	282-698/281-413	79		
281-421	72	282-104	74	282-698/281-429	79		
				282-698/281-434	79		

Item Number Index

Item No.	Page	Item No.	Page	Item No.	Page	Item No.	Page
294 Series		706 Series		713 Series		721 Series	
294-5153	101	706-100/1602-200	205	713-1403/037-000	115	721-202/037-000	121
294-5155	101	706-2300/100-100	232				
294-5175	101	706-2300/100-200	232	713-1418/037-000	115	721-212/037-000	121
294-5213	101	706-2300/100-300	232	713-1403/105-000	115	721-232/001-000	121
294-5214	101	706-2300/101-100	232				
294-5215	101	706-2300/101-200	232	713-1418/105-000	115	721-242/001-000	121
294-5223	101	706-2300/101-300	232	713-1403/107-000	115	721-262/001-000	121
294-5224	101	706-2300/200-100	232				
294-5225	101	706-2300/200-200	232	713-1418/107-000	115	721-272/001-000	121
294-5235	101	706-2300/200-300	232	713-1403/116-000	115	721-302/008-000	118
294-5253	101	706-2300/201-100	232				
294-5255	101	706-2300/201-200	232	713-1418/116-000	115	721-320/008-000	118
294-5275	101	706-2300/201-300	232	713-1403/117-000	115	721-302/031-000	118
294-5313	101	706-2300/300-100	232				
294-5314	101	706-2300/300-200	232	713-1418/117-000	115	721-320/031-000	118
294-5315	101	706-2300/300-300	232	713-1423	115	721-332/008-000	121
294-5323	101	706-2300/301-100	232				
294-5324	101	706-2300/301-200	232	713-1438	115	721-342/008-000	121
294-5325	101	706-2300/301-300	232	713-1423/037-000	115	721-332/031-000	121
294-5335	101						
294-5355	101	706-2300/400-100	232	713-1438/037-000	115	721-342/031-000	121
294-5375	101	706-2300/400-200	232	713-1423/105-000	115	721-432/001-000	118
		706-2300/400-300	232				
294-5413	101	706-2300/404-100	232	713-1438/105-000	115	721-450/001-000	118
294-5414	101	706-2300/404-200	232	713-1423/107-000	115	721-462/001-000	118
294-5415	101	706-2300/404-300	232				
294-5423	101	706-2300/406-100	232	713-1438/107-000	115	721-480/001-000	118
294-5424	101	706-2300/406-200	232	713-1423/116-000	115	721-602	118
294-5425	101	706-2300/406-300	232				
294-5435	101	706-2300/500-100	233	713-1438/116-000	115	721-620	118
294-5453	101	706-2300/500-200	233	713-1423/117-000	115	721-602/018-000	118
294-5455	101	706-2300/500-300	233				
294-5475	101	706-2300/502-100	233	713-1438/117-000	115	721-620/018-000	118
		706-2300/502-200	233			721-602/019-000	118
		706-2300/502-300	233	714 Series			
294-8013	103			714-102	115	721-620/019-000	118
294-8015	103	706-3057/300-100	232			721-602/114-000	118
294-8022	103	706-3057/300-200	232	714-116	115		
294-8024	103	706-3057/300-300	232	714-132	115	721-620/114-000	118
294-8025	103	706-7753/300-100	232			721-832/001-000	121
294-8035	103	706-7753/300-200	232	714-146	115		
294-8113	103	706-7753/300-300	232	714-162	115	721-842/001-000	121
294-8115	103	706-7753/301-100	232			721-862/001-000	121
294-8124	103	706-7753/301-200	232	714-176	115		
294-8125	103	706-7753/301-300	232	721 Series		721-872/001-000	121
294-8135	103	706-7753/301-300	232	721-102/008-000	118	721-2102/026-000	118
294-8213	103	706-7753/302-100	232				
294-8215	103	706-7753/302-200	232	721-120/008-000	118	721-2116/026-000	118
294-8224	103	706-7753/302-300	232	721-102/026-000	118	721-2102/037-000	118
294-8225	103						
294-8235	103	709 Series		721-120/031-000	118	721-2116/037-000	118
294-8313	103	709-107	89	721-102/037-000	118	721-2202/026-000	121
294-8315	103	709-118	249				
294-8324	103	709-119	249	721-120/026-000	118	721-2212/026-000	121
294-8325	103	709-153	250	721-102/031-000	118	721-2202/037-000	121
294-8335	103	709-154	250				
294-8413	103	709-167	250	721-120/031-000	118	721-2212/037-000	121
294-8415	103	709-168	250	721-102/037-000	118		
294-8424	103	709-177	244			722-102/026-000	118
294-8425	103	709-178	244	721-120/037-000	118		
294-8435	103	709-183	250	721-132/001-000	118	722-120/026-000	118
		709-350	185			722-132	118
		709-352	185	721-150/001-000	118		
		709-591	250	721-162/001-000	118	722-150	118
704 Series		713 Series				722-132/005-000	118
704-2003	233	713-1103	115	721-180/001-000	118		
704-2004	233			721-162/003-000	118	722-150/005-000	118
704-2024	233	713-1118	115	721-180/003-000	118	722-150/005-000	118
704-2044	233	713-1103/037-000	115	721-162/100-000	118	722-132/005-000/039-000	118
704-2054	233						
704-5003	233	713-1118/037-000	115	721-172/100-000	118	722-150/005-000/039-000	118
704-5004	233	713-1103/107-000	115	721-202/008-000	121	722-132/031-000	118
704-5013	233						
704-5014	233	713-1118/107-000	115	721-212/008-000	121	722-150/031-000	118
704-5024	233	713-1403	115	721-202/026-000	121	722-132/039-000	118
704-5034	233						
704-5044	233	713-1418	115	721-212/026-000	121	722-150/039-000	118
704-5054	233			721-202/031-000	121	722-132/047-000	118
704-5054	233						
704-5064	233			721-212/031-000	121	722-150/047-000	118
704-5074	233						
704-8012	233						
704-8013	233						

Item No.	Page	Item No.	Page	Item No.	Page	Item No.	Page
722 Series		726 Series		731 Series		734 Series	
722-202/026-000	118	726-721	87	731-602	122	734-130	125
		726-741	87			734-132	116
722-220/026-000	118	726-750	87	731-616	122		
722-232	118	726-770	87	731-602/018-000	122	734-154	116
		726-821	87			734-132/100-000	116
722-250	118	726-841	87	731-616/018-000	122		
722-232/031-000	118	726-850	87	731-602/019-000	122	734-142/100-000	116
		726-901	87			734-132/105-604	116
722-250/031-000	118	726-903	87	731-616/019-000	122		
722-232/039-000	118	726-904	87	731-602/114-000	122	734-146/105-604	116
		726-905	87			734-132/108-000	116
722-250/039-000	118	726-906	87	731-616/114-000	122		
722-232/047-000	118	726-907	87	731-632	123	734-154/108-000	116
		727 Series				734-159	125
722-250/047-000	118	727-105	89	731-642	123	734-162	116
722-732	121	727-106	89	731-632/018-000	123		
		727-117	89			734-184	116
722-742	121	727-119	89	731-642/018-000	123	734-162/105-604	116
722-732/031-000	121	727-120	89	731-632/019-000	123		
		727-121	89			734-176/105-604	116
722-742/031-000	121	727-122	89	731-642/019-000	123	734-162/108-000	116
722-732/039-000	121	727-123	89	731-632/114-000	123		
		727-124	89			734-184/108-000	116
722-742/039-000	121	727-125	89	731-646/114-000	123	734-190	254
722-732/047-000	121	727-126	89	732 Series		734-191	254
		727-127	89	732-122/026-000	123	734-202	117
722-742/047-000	121	727-128	89				
722-832	121	727-129	89	732-132/026-000	123	734-220	117
		727-130	89	732-125/026-000/033-000	125	734-202/008-000	117
722-842	121	727-131	89	733 Series		734-220/008-000	117
722-832/031-000	121	727-132	89	733-102	115	734-202/037-000	117
		727-133	89				
722-842/031-000	121	727-134	89	733-112	115	734-220/037-000	117
722-832/039-000	121	727-135	89			734-226	125
		727-136	89	733-102/037-000	115	734-227	125
722-842/039-000	121	727-137	89			734-228	125
722-832/047-000	121	727-138	89	733-112/037-000	115	734-229	125
		727-139	89			734-230	254
722-842/047-000	121	727-140	89	733-130	254	734-231	254
723 Series		727-197	89	733-191	254	734-232	117
723-602	121	727-198	89	733-202	115		
		727-199	89			734-250	117
723-612	121	727-205	89	733-212	115	734-232/100-000	117
723-602/018-000	121	727-206	89	733-212	115		
		727-207	89	733-330	125	734-242/100-000	117
723-612/018-000	121	727-217	89	733-331	125	734-232/105-604	117
723-612/019-000	121	727-219	89	733-332	115		
		727-220	89			734-242/105-604	117
723-602/019-000	121	727-221	89	733-342	115	734-262	117
723-602/114-000	121	727-222	89	733-332/100-000	115		
		727-223	89			734-280	117
723-612/114-000	121	727-224	89	733-342/100-000	115	734-262/105-604	117
726 Series		727-225	89	733-332/105-604	115		
726-121	87	727-226	89			734-272/105-604	117
726-122	87	727-227	89	733-342/105-604	115	734-302	116
726-141	87	727-228	89	733-362	115		
726-142	87	727-229	89			734-324	116
726-221	87	727-230	89	733-372	115	734-302/018-000	116
726-222	87	727-231	89				
726-241	87	727-232	89	733-362/105-604	115	734-324/018-000	116
726-242	87	727-233	89			734-302/019-000	116
726-321	87	727-234	89	733-372/105-604	115		
726-322	87	727-235	89	734 Series		734-324/019-000	116
726-341	87	727-236	89	734-102	116	734-302/109-000	116
726-342	87	727-237	89				
731 Series		727-238	89	734-124	116	734-324/109-000	116
731-502/008-000	119	731 Series		734-102/008-000	116	734-326	67
		731-502/008-000	119			734-327	67
731-520/008-000	119	731-502/031-000	119	734-124/008-000	116	734-328	67
				734-102/037-000	116	734-329	67
731-520/031-000	119	731-520/031-000	119			734-332	117
731-532/008-000	122	731-532/008-000	122	734-124/037-000	116		
				734-102/107-000	116	734-350	117
731-546/008-000	122					734-332/018-000	117
731-532/031-000	122	731-546/008-000	122	734-124/107-000	116		
		731-532/031-000	122	734-126	125	734-350/018-000	117
731-546/031-000	122			734-127	125	734-332/019-000	117
732 Series		731-602	122	734-128	125	734-350/019-000	117
732-122/026-000	123			734-129	125		
		731-602	122				
732-132/026-000	123	731-616	122				
732-125/026-000/033-000	125	731-602/018-000	122				
733 Series		731-616/018-000	122				
733-102	115	731-602/019-000	122				
		731-616/019-000	122				
733-112	115	731-602/114-000	122				
733-102/037-000	115	726-901	87				
		726-903	87				
733-112/037-000	115	726-904	87				
		726-905	87				
733-130	254	726-906	87				
733-191	254	726-907	87				
733-202	115	727 Series					
		727-105	89				
734-250	117	727-106	89				
734-232/100-000	117	727-117	89				
		727-119	89				
734-242/100-000	117	727-120	89				
734-232/105-604	117	727-121	89				
		727-122	89				
734-242/105-604	117	727-123	89				
734-262	117	727-124	89				
		727-125	89				
734-280	117	727-126	89				
734-262/105-604	117	727-127	89				
		727-128	89				
734-272/105-604	117	727-129	89				
734-302	116	727-130	89				
		727-131	89				
734-324	116	727-132	89				
734-302/018-000	116	727-133	89				
		727-134	89				
734-324/018-000	116	727-135	89				
734-302/019-000	116	727-136	89				
		727-137	89				
734-324/019-000	116	727-138	89				
734-302/109-000	116	727-139	89				
		727-197	89				
734-324/109-000	116	727-198	89				
734-326	67	727-199	89				
734-327	67	727-205	89				
734-328	67	727-206	89				
734-329	67	727-217	89				
734-332	117	727-219	89				
		727-220	89				
734-350	117	727-221	89				
734-332/018-000	117	727-222	89				
		727-223	89				
734-350/018-000	117	727-224	89				
734-332/019-000	117	727-225	89				
		727-226	89				
734-350/019-000	117	727-227	89				
		727-228	89				
734-350/019-000	117	727-229	89				
		727-230	89				
734-350/019-000	117	727-231	89				
		727-232	89				
734-350/019-000	117	727-233	89				
		727-234	89				
734-350/019-000	117	727-235	89				
		727-236	89				
734-350/019-000	117	727-237	89				
		727-238	89				
734-350/019-000	117	731 Series					
		731-502/008-000	119				
734-350/019-000	117						
		731-520/008-000	119	</			

Item Number Index

Item No.	Page	Item No.	Page	Item No.	Page	Item No.	Page
734 Series		736 Series		739 Series		745 Series	
734-362	116	736-302	129	739-3202	131	745-582	132
734-372	116	736-324	129	739-3212	131	745-585	132
734-362/008-000	116	736-502	130			745-602/006-000	132
				740 Series			
734-372/008-000	116	736-516	130	740-102	129	745-605/006-000	132
		736-602	130			745-631	132
734-362/037-000	116			740-124	129		
		736-616	130			745-635	132
734-372/037-000	116	736-702	131	741-102	129	745-652/006-000	132
734-400	125						
734-402	116	736-712	131	741 Series		745-655/006-000	132
		736-802	131	741-102	129	745-681	132
734-412	116						
734-402/001-000	116	736-812	131	741-116	129	745-685	132
				741-202	129	745-1352	131
734-412/001-000	116	737 Series					
734-426	125	737-102	129	741-216	129	745-1362	131
734-427	125			741-302	130	745-1402	132
734-428	125	737-124	129				
734-429	125	737-302	129	741-310	130	745-1412	132
734-430	125			741-402	130	745-1452	132
734-431	125	737-324	129				
734-432	117	737-502	130	741-410	130	745-1462	132
				741-502	131	745-3102	129
734-442	117	737-516	130				
734-432/001-000	117	737-602	130	741-508	131	745-3112	129
		737-616	130	741-602	131	745-3152	130
734-442/001-000	117	737-702	131				
734-462	116			741-608	131	745-3162	130
		737-712	131			745-3202	131
734-484	116	737-802	131	742 Series			
734-462/037-000	116			742-101	129	745-3212	131
		737-812	131			745-3252	132
734-484/037-000	116			742-178	129		
734-502	117	738 Series				745-3262	132
		738-102	129	744 Series			
734-520	117			744-203	128	746 Series	
734-502/037-000	117	738-124	129			746-2302	130
		738-302	129	744-208	128		
734-520/037-000	117			744-210	128	746-2312	130
734-532	116	738-324	129	744-292	128		
				745 Series		750 Series	
734-554	116	739 Series		745-102	129	750-100	178
734-532/037-000	116	739-102	129			750-103	178
				745-112	129	750-106	178
734-580	117	739-124	129	745-152	130	750-107	178
734-562/037-000	117					750-303	159
		739-174	129	745-162	130	750-304	159
734-580/037-000	117	739-153/100-000	129	745-181	132	750-306	159
734-602	124	739-162/100-000	129			750-307	159
		739-202	130	745-185	132	750-310	159
734-610	124			745-191	132	750-315/300-000	159
734-612	124	739-212	130			750-316/300-000	159
734-632	124	739-203/100-000	130	745-195	132	750-331	159
				745-202	131	750-333	159
734-636	124	739-212/100-000	130			750-333/025-000	159
734-638	124	739-232	130	745-195	132	750-333/040-000	177
734-639	124			745-202	131	750-334	159
734-640	124	739-242	130			750-337	159
734-642	124	739-233/100-000	130	745-212	131	750-337/025-000	159
734-671	125			745-281	132	750-338	159
		739-242/100-000	130			750-338/040-000	177
735 Series		739-302	128	745-285	132	750-340	159
735-122	128			745-302	130	750-342	159
		739-312	128			750-343	159
735-127	128	739-303/100-000	128	745-312	130	750-344	159
735-302	129			745-352	131	750-345	159
		739-312/100-000	128			750-346	159
735-307	129	739-332	128	745-362	131	750-347	159
735-500	262			745-381	132	750-348	159
		739-342	128				
736 Series		739-333/100-000	128	745-385	132	750-351	159
736-102	129			745-391	132	750-352	159
		739-342/100-000	128			750-352/040-000	177
				745-395	132	750-354	159
				745-502/006-000	131	750-354/000-001	159
						750-370	159
				745-505/006-000	131	750-375	159

Item No.	Page	Item No.	Page	Item No.	Page	Item No.	Page
750 Series		750 Series		750 Series		750 Series	
750-375/025-000	159	750-465/025-000	165	750-512	163	750-626/025-001	173
750-377	159	750-466	165	750-513	163	750-626/040-000	177
750-377/025-000	159	750-466/000-200	165	750-513/000-001	163	750-627	173
750-400	161	750-466/025-000	165	750-514	163	750-628	173
750-400/025-000	161	750-467	165	750-516	163	750-630	169
750-401	161	750-467/000-200	165	750-517	163	750-630/000-001	169
750-402	161	750-468	165	750-517/040-000	177	750-630/000-002	169
750-402/025-000	161	750-468/000-200	165	750-519	163	750-630/000-004	169
750-403	161	750-468/025-000	165	750-522	163	750-630/000-005	169
750-404	169	750-468/040-000	177	750-523	163	750-630/000-006	169
750-404/000-001	169	750-469	165	750-530	163	750-630/000-008	169
750-404/000-002	169	750-469/000-006	165	750-530/025-000	163	750-630/000-009	169
750-404/000-003	169	750-469/000-200	165	750-531	163	750-630/000-011	169
750-404/000-004	169	750-469/003-000	165	750-531/000-800	163	750-630/000-012	169
750-404/000-005	169	750-469/040-000	177	750-532	163	750-630/000-013	169
750-405	161	750-470	165	750-534	163	750-630/003-000	169
750-406	161	750-470/005-000	165	750-535	175	750-631/000-004	169
750-407	161	750-472	165	750-536	163	750-632	169
750-407/040-000	177	750-472/000-200	165	750-537	163	750-633	175
750-408	161	750-472/005-000	165	750-538	175	750-635	169
750-408/025-000	161	750-473	165			750-636	169
750-409	161	750-473/005-000	165	750-550	167	750-636/000-700	169
750-410	161	750-474	165	750-550/000-200	167	750-636/000-800	169
750-411	161	750-474/000-200	165	750-552	167	750-636/025-000	169
750-412	161	750-474/005-000	165	750-552/000-200	167	750-637	169
750-414	161	750-475	165	750-552/025-000	167	750-637/000-001	169
750-415	161	750-475/020-000	165	750-553	167	750-637/000-002	169
750-418	161	750-476	165	750-554	167	750-637/000-003	169
750-421	161	750-476/000-200	165	750-554/000-200	167	750-637/000-004	169
750-422	161	750-477	165	750-554/025-000	167	750-638	169
750-423	161	750-478	165	750-555	167	750-638/025-000	169
750-424	161	750-478/005-000	165	750-556	167	750-640	169
750-425	161	750-479	165	750-556/000-200	167	750-642	171
750-427	161	750-479/000-001	165	750-557	167	750-643	171
750-427/040-000	177			750-557/040-000	177	750-644	171
750-428	161	750-480	165	750-559	167	750-645	169
750-429/040-001	177	750-480/000-001	165	750-559/025-000	167		
750-430	161	750-481/003-000	175	750-559/040-000	177	750-650	171
750-430/025-000	161	750-482	165	750-560	167	750-650/000-001	171
750-431	161	750-482/000-300	165	750-562	167	750-650/000-002	171
750-432	161	750-482/025-000	165	750-563	167	750-650/000-006	171
750-433	161	750-483	165	750-563/040-000	177	750-650/000-010	171
750-435	175	750-484	175	750-585	175	750-650/000-011	171
750-436	161	750-485	175	750-586	175	750-650/000-012	171
750-437	161	750-487/003-000	175			750-650/000-015	171
750-438	175	750-491	165	750-600	173	750-650/003-000	171
750-439	175	750-491/000-001	165	750-600/025-000	173	750-651	171
		750-492	165	750-600/040-000	177	750-651/000-002	171
750-450	165	750-492/040-001	177	750-601	173	750-652	171
750-451	165	750-493	165	750-602	173	750-652/025-000	171
750-452	165	750-493/000-001	165	750-602/025-000	173	750-652/040-000	177
750-452/000-200	165	750-494	165	750-602/040-000	177	750-653	171
750-453	165	750-494/000-001	165	750-603	173	750-653/000-001	171
750-453/040-000	177	750-494/025-000	165	750-604	173	750-653/000-002	171
750-454	165	750-494/025-001	165	750-606	174	750-653/000-006	171
750-454/000-200	165	750-495	165	750-609	173	750-653/003-000	171
750-454/025-000	165	750-495/000-001	165	750-610	173	750-653/025-000	171
750-455	165	750-495/000-002	165	750-611	173	750-653/025-018	171
750-455/020-000	165	750-495/040-000	177	750-612	173	750-654	171
750-455/025-000	165	750-495/040-001	177	750-612/040-000	177	750-655	171
750-455/040-000	177	750-495/040-002	177	750-613	173	750-657	171
750-456	165	750-496	165	750-613/040-000	177	750-658	171
750-456/000-200	165	750-497	165	750-614	173	750-660/000-001	174
750-457	165			750-615	173	750-661/000-003	174
750-457/025-000	165	750-501	163	750-616	173	750-662/000-003	174
750-457/040-000	177	750-501/000-800	163	750-616/030-000	173	750-663/000-003	174
750-458	165	750-502	163	750-616/040-000	177	750-665/000-001	174
750-459	165	750-502/000-800	163	750-617	173	750-666/000-003	174
750-460	165	750-504	163	750-621	173	750-667/000-003	174
750-460/000-003	165	750-504/000-800	163	750-622	173	750-670	169
750-460/000-005	165	750-504/025-000	163	750-623	173	750-671	169
750-461	165	750-504/025-800	163	750-624	173	750-672	169
750-461/000-200	165	750-506	163	750-624/000-001	173	750-673	169
750-461/003-000	165	750-506/000-800	163	750-624/020-000	173		
750-461/020-000	165	750-508	163	750-624/020-001	173	750-804	157
750-461/025-000	165	750-508/000-800	163	750-624/040-001	177	750-806	157
750-463	165	750-508/040-000	177	750-625	173	750-815/300-000	157
750-464	165	750-509	163	750-625/000-001	174	750-815/325-000	157
750-464/020-000	165	750-511	169	750-626	173	750-816/300-000	157
750-464/040-000	177	750-511/000-001	169	750-626/020-000	173	750-829	157
750-465	165	750-511/000-002	169	750-626/025-000	173	750-830	157

Item Number Index

Item No.	Page	Item No.	Page	Item No.	Page	Item No.	Page
750 Series		750 Series		753 Series		756 Series	
750-831	157	750-8203/025-000	156	753-506	163	756-3102/040-200	182
750-833	157	750-8204	156	753-508	163	756-3103/040-020	182
750-833/025-000	157	750-8204/025-000	156	753-509	163	756-3103/040-200	182
750-837	157	750-8206	156	753-511	169	756-3104/040-020	182
750-838	157	750-8206/025-000	156	753-512	163	756-3104/040-200	182
750-838/040-000	177	750-8206/025-001	156	753-513	163	756-3105/040-002	182
750-842	157	750-8206/040-000	177	753-514	163	756-3105/040-200	182
750-843	157	750-8206/040-001	177	753-516	163	756-3106/040-002	182
750-852	157	750-8207	156	753-517	163	756-3106/040-200	182
750-872	157	750-8207/025-000	156	753-530	163	756-3201/120-050	183
750-873	157	750-8207/025-001	156	753-531	163	756-3201/120-150	183
750-880	157	753 Series		753-531/000-800	163	756-3202/120-050	183
750-880/025-000	157	753-110	178	753-534	163	756-3202/120-150	183
750-880/025-001	157	753-120	178	753-536	163	756-3203/190-050	183
750-880/025-002	157	753-150	178	753-537	163	756-3203/190-150	183
750-880/040-000	177	753-400	161	753-540	163	756-3204/190-050	183
750-880/040-001	177	753-401	161	753-550	167	756-3204/190-150	183
750-881	157	753-402	161	753-552	167	756-3205/140-050	183
750-882	157	753-403	161	753-553	167	756-3205/140-150	183
750-885	157	753-404	161	753-554	167	756-3206/140-050	183
750-885/025-000	157	753-404	169	753-555	167	756-3206/140-150	183
750-889	157	753-404/000-003	169	753-556	167	756-4101/042-030	181
		753-404/000-005	169	753-557	167	756-8101	181
750-921	179	753-405	161	753-559	167	756-8102	181
750-923	179	753-406	161				
750-923/000-001	179	753-408	161	753-602	173	757 Series	
750-960	179	753-409	161	753-603	173	757-000	183
750-961	179	753-410	161	753-604	173	757-011	183
750-962	179	753-411	161	753-612	173	757-040	183
750-963	179	753-412	161	753-614	173	757-060	183
750-965	179	753-415	161	753-620	173	757-080	183
750-971	179	753-418	161	753-629/020-000	173	757-080	183
750-972	179	753-421	161	753-635	169	757-144	183
750-975	179	753-422	161	753-638	169	757-145	183
750-976	179	753-423	161	753-646	171	757-164	183
		753-424	161	753-647	171	757-165	183
750-1400	161	753-425	161	753-648	171	757-184	183
750-1402	161	753-427	161	753-650	171	757-185	183
750-1405	161	753-428	161	753-650/003-000	171	757-185/100-000	183
750-1405/040-000	177	753-429	161	753-652	171		
750-1406	161	753-430	161	753-653	171	757-244/000-005	183
750-1407	161	753-431	161	753-653/003-000	171	757-244/000-010	183
750-1415	161	753-432	161	753-655	171	757-245/000-005	183
750-1415/040-000	177	753-433	161	753-661/000-003	174	757-245/000-010	183
750-1416	161	753-434	161	753-662/000-003	174	757-264/000-005	183
750-1416/040-000	177	753-436	161	753-666/000-003	174	757-264/000-010	183
750-1417	161	753-437	161	753-667/000-003	174	757-265/000-005	183
750-1418	161	753-440	161	753-1629	173	757-265/000-010	183
750-1420	161			753-1629/000-001	173	757-284/000-005	183
750-1421	161					757-284/000-010	183
750-1422	161	753-452	165	755 Series		757-284/000-025	183
750-1423	161	753-453	165	755-8103	181	757-285/000-005	183
750-1425	161	753-454	165	755-8104	181	757-285/000-010	183
		753-455	165			757-285/000-025	183
750-1500	163	753-456	165	756 Series		757-303	183
750-1501	163	753-457	165	756-1201/060-020	182	757-343	183
750-1502	161	753-459	165	756-1201/060-200	182	757-363	183
750-1504	163	753-461	165	756-1202/060-020	182	757-383	183
750-1505	163	753-461/003-000	165	756-1202/060-200	182		
750-1506	161	753-465	165	756-1203/060-020	182	757-403/000-005	183
750-1515	163	753-466	165	756-1203/060-200	182	757-403/000-010	183
750-1515/040-000	177	753-467	165	756-1204/060-020	182	757-443/000-002	183
750-1516	163	753-469	165	756-1204/060-200	182	757-443/000-005	183
750-1605	173	753-469/003-000	165	756-1301/060-020	182	757-443/000-010	183
750-1605/040-000	177	753-472	165	756-1301/060-200	182	757-463/000-005	183
750-1606	173	753-474	165	756-1302/060-020	182	757-463/000-010	183
750-1606/040-000	177	753-475	165	756-1302/060-200	182	757-483/000-005	183
750-1607	173	753-476	165	756-1303/060-020	182	757-483/000-010	183
		753-477	165	756-1303/060-200	182	757-901/000-050	244
750-8100	156	753-478	165	756-1304/060-020	182	758 Series	
750-8101	156	753-479	165	756-1304/060-200	182	758-879/000-000	151
750-8101/025-000	156	753-480	165	756-1305/060-002	182	758-879/000-001	151
750-8102	156	753-482	165	756-1305/060-500	182	758-879/000-002	150
750-8102/025-000	156	753-483	165	756-1306/060-002	182	758-879/000-100	151
750-8202	156	753-492	165	756-1306/060-500	182	758-879/000-101	151
750-8202/025-000	156					758-879/000-300	151
750-8202/025-001	156	753-501	163			758-879/000-301	151
750-8202/025-002	156	753-501/000-800	163			758-879/000-302	151
750-8202/040-000	177	753-502	163	756-3101/040-020	182	758-879/000-302	151
750-8202/040-001	177	753-502/000-800	163	756-3101/040-200	182	758-879/000-303	151
750-8203	156	753-504	163	756-3102/040-020	182		

Item No.	Page	Item No.	Page	Item No.	Page	Item No.	Page
758 Series		767 Series		769 Series		773 Series	
758-879/000-304	151	767-5803	181	769-306	84	773-116	107
758-910	179	767-5803/000-800	181	769-307	84	773-118	107
758-912	179	767-6401	181	769-308	84	773-132	107
758-915	179	767-6402	181	769-309	85	773-134	107
758-916	179	767-6403	181	769-310	85	773-136	107
758-917	179	767-7401	181	769-311	85	773-138	107
		767-9101	181	769-312	85	773-166	107
				769-313	85	773-173	107
759 Series		769 Series		769-314	85	773-331	107
759-302	148	769-101	84	769-315	85	773-332	107
759-302/000-923	148			769-316	85	773-492	107
759-333	148	769-115	84	769-317	85	773-493	107
759-333/000-923	148	769-101/000-016	84	769-318	85	773-494	107
759-850	193	769-101/022-000	84	769-319	85	773-496	107
759-851	193			769-320	84	773-498	107
759-911	148	769-115/022-000	84	769-321	84	773-514	107
759-920	148	769-101/022-016	84	769-410	85	773-602	107
		769-121	84	769-411	85	773-604	107
762 Series				769-412	85	773-606	107
762-1035	151	769-135	84	769-413	85		
762-1057	151	769-121/000-016	84	769-414	85	777 Series	
762-1104	151	769-151	84	769-434	254	777-303	41
762-1121	151	769-156	84	769-1602	85		
762-3000	150	769-161	85			780 Series	
762-3001	150	769-162/769-313	85	769-1615	85	780-452	72
762-3002	150	769-163/769-313	85			780-453	72
762-3003	150	769-164/769-313	85	770 Series		780-454	72
762-3035/000-001	151	769-165/769-313	85	770-111	140	780-455	72
762-3057/000-001	151	769-171	84	770-131	140	780-456	72
762-3104/000-001	151	769-176	84	770-201	140	780-457	72
762-3121/000-001	151	769-181	85	770-202	140	780-458	72
762-3150/000-001	151	769-182/769-314	85	770-203	140		
762-3150/000-003	151	769-183/769-314	85	770-204	140	781 Series	
		769-184/769-314	85	770-205	140	781-452	72
		769-185/769-314	85	770-212	140	781-453	72
		769-191	85	770-213	140	781-454	72
		769-192/769-319	236	770-214	140	781-455	72
		769-193/769-319	236	770-215	140	781-456	72
		769-194/769-319	236	770-221	140		
		769-195/769-319	236	770-222	140	787 Series	
				770-223	140	787-712	188
				770-224	140	787-722	188
		769-201	84	770-225	140	787-732	188
		769-202	85	770-232	140	787-734	188
		769-203	85	770-233	140	787-736	188
		769-207	84	770-234	140	787-738	188
		769-208/281-410	85	770-235	140	787-740	188
		769-208/281-411	85			787-742	188
		769-209/281-413	85	770-360	140	787-783	199
		769-209/281-434	85	770-401	140	787-785	199
		769-211	84	770-502/041-000	140		
		769-212	85	770-503	140	787-818	192
		769-213	85	770-504	140	787-819	192
		769-214	85	770-505	140	787-821	192
		769-217	84	770-512/041-000	140	787-822	192
		769-218/281-410	85	770-513	140	787-831	192
		769-218/281-411	85	770-514	140	787-832	192
		769-219/281-413	85	770-515	140	787-833	192
		769-219/281-434	85			787-834	192
		769-221	84	770-703	141	787-835	192
		769-222	84	770-704	141	787-840	193
		769-223	84	770-705	141	787-842	193
		769-227	84	770-713	141	787-844	193
		769-228/281-410	84	770-714	141	787-845	193
		769-228/281-411	84	770-715	141	787-847	193
		769-229/281-413	84	770-723	141	787-850	193
		769-229/281-434	84	770-724	141	787-852	193
		769-231	84	770-725	141	787-854	193
		769-232	84	770-733	141	787-860	196
		769-233	84	770-734	141	787-861	196
		769-237	84	770-735	141	787-862	196
		769-238/281-410	84			787-870	198
		769-238/281-411	84	773 Series		787-871	198
		769-239/281-413	84	773-102	107	787-872	198
		769-239/281-434	84	773-104	107	787-873	198
		769-251	84	773-106	107	787-875	198
		769-257	84	773-108	107	787-876	198
				773-112	107		
		769-301	84	773-114	107		
		769-302	84				
		769-305	84				

Item Number Index

Item No.	Page	Item No.	Page	Item No.	Page	Item No.	Page
787 Series		788 Series		790 Series		793 Series	
787-880	199	788-124	213	790-101	185	793-5501	245
787-881	199	788-125	213	790-108	185	793-5502	245
787-885	199	788-148	213	790-112	185	793-5503	245
787-886	199			790-113	185	793-5504	245
		788-150	213	790-114	185	793-5505	245
787-1001	189	788-152	213	790-115	185	793-5506	245
787-1002	189	788-154	213	790-116	185	793-5507	245
787-1011	189	788-156	213	790-124	185	793-5508	245
787-1012	189	788-158	213	790-133	185	793-5509	245
787-1014	194	788-160	213	790-134	185	793-5544	245
787-1014/072-000	194	788-162	213	790-140	185	793-5545	245
787-1017	189	788-164	213	790-144	185	793-5565	245
787-1020	189	788-166	213	790-145	185	793-5566	245
787-1021	189	788-168	213	790-190	185	793-5599	245
787-1022	189	788-170	213	790-191	185		
		788-172	213	790-208	185	794 Series	
787-1601	190	788-174	213	790-216	185	794-557	245
787-1602	190	788-176	213	790-220	185	794-5557	245
787-1606	190	788-178	213	790-300	185		
787-1611	190	788-180	213	790-301	185	804 Series	
787-1616	190			790-350/790-398	185	804-102	129
787-1616/000-1000	191	788-303	212	790-352/790-398	185		
787-1621	190	788-304	212	790-360/790-398	185	804-116	129
787-1622	190	788-305	212	790-362/790-398	185	804-302	130
787-1623	191	788-306	212	790-398	185		
787-1628	191	788-307	212	790-495	224	804-312	130
787-1631	190	788-311	212			805 Series	
787-1632	190	788-312	212	793 Series		805-102	128
787-1633	191	788-313	212	793-501	245		
787-1634	191	788-314	212	793-501/000-002	51	805-124	128
787-1635	191	788-315	212	793-501/000-005	51	805-302/200-604	128
787-1640	191	788-341	212	793-501/000-006	51		
787-1642	191	788-346	212	793-501/000-007	51	805-308/200-604	128
787-1644	191	788-354	212	793-501/000-012	51		
787-1662	195	788-384	212	793-501/000-017	51		
787-1662/000-100	197	788-404	212	793-501/000-023	51		
787-1662/000-200	197	788-412	212	793-501/000-024	51		
787-1662/006-1000	195			793-502	245	806 Series	
787-1662/106-000	195	788-506	212	793-503	245	806-102	132
787-1662/212-1000	195	788-507	212	793-504	245		
787-1664	195	788-508	212	793-505	245	806-112	132
787-1664/000-004	195	788-512	212	793-506	245		
787-1664/000-100	197	788-515	212	793-507	245	807 Series	
787-1664/000-200	197	788-516	212	793-508	245	807-090/101-100	246
787-1664/006-1000	195	788-607	212	793-508	245		
787-1664/106-000	195	788-608	212	793-509	245		
787-1664/212-1000	195	788-615	212	793-544	245		
787-1668	196	788-616	212	793-545	245		
787-1668/000-004	196	788-700	213	793-565	245		
787-1668/000-200	197	788-701	213	793-566	245	811 Series	
787-1668/006-1000	196	788-720	213	793-599	245	811-310	79
787-1668/106-000	196	788-721	213			811-311	79
787-1675	198			793-3501	245	811-314	79
787-1685	199	789 Series		793-3502	245	811-316	79
		789-112	215	793-3503	245	811-317	79
787-1702	188	789-304	215	793-3504	245	811-320	79
787-1712	188	789-312	215	793-3505	245	811-321	79
787-1722	188	789-323	215	793-3506	245	811-330	79
787-1732	188	789-325	215	793-3507	245	811-331	79
787-2801	194	789-508	215	793-3508	245		
787-2802	194	789-512	215	793-3509	245	811-410	79
787-2803	194	789-516	215	793-3544	245	811-411	79
787-2805	194	789-516	215	793-3545	245	811-414	79
787-2810	194	789-535	215	793-3565	245	811-420	79
787-2852	204	789-536	215	793-3566	245	811-421	79
		789-551	215			811-430	79
		789-552	215	793-4501	245	811-431	79
		789-570	215	793-4502	245	811-472	79
		789-571	215	793-4503	245		
				793-4504	245	811-482	79
		789-620	228	793-4505	245		
		789-621	228	793-4506	245	812 Series	
		789-622	228	793-4507	245	812-100	91
		789-652	229	793-4508	245	812-101	91
		789-654	229	793-4509	245	812-102	91
		789-1341	215	793-4544	245	812-103	91
		789-1544	215	793-4545	245	812-104	91
				793-4565	245	812-110	91
		790 Series		793-4566	245	812-111	91
		790-100	185	793-4599	245	812-112	91

Item No.	Page	Item No.	Page	Item No.	Page	Item No.	Page
812 Series		855 Series		857 Series		859 Series	
812-113	91	855-505/1000-1001	226	857-531	204	859-402	204
812-114	91	855-601/1500-501	226	857-550	202		
812-140	91	855-605/1500-501	226	857-552	202	859-410	204
812-141	91	855-801/2000-1001	226	857-604	209	859-702	211
		855-805/2000-1001	226	857-624	209	859-706	211
				857-634	209	859-708	211
816 Series		855-1001/2500-1001	226	857-640	209	859-712	211
816-102	129	855-1005/2500-1001	226	857-642	209	859-720	211
		855-1700/032-000	228	857-704	208	859-730	211
816-112	129	855-2701	228	857-707	208	859-740	211
831 Series		855-2701/035-001	228	857-708	208	859-744	211
		855-2701/064-001	228	857-714	208	859-752	211
831-3102	123	855-3001/060-003	227	857-717	208	859-756	211
		855-3001/100-003	227	857-718	208	859-758	211
831-3109	123	855-3001/200-001	227	857-724	208	859-772	211
831-3102/037-000	123	855-3001/250-001	227	857-727	208	859-791	211
		855-4001/100-001	227	857-728	208	859-793	211
831-3109/037-000	123	855-4001/150-001	227	857-800	202	859-794	211
831-3202	123	855-4001/200-001	227	857-801	202	859-795	211
		855-4005/150-101	227	857-809	204	859-796	211
831-3209	123	855-4101/200-001	227	857-810	202	859-902	211
831-3202/007-000	123	855-4101/250-001	227	857-811	202		
		855-4101/400-001	227	857-818	202	862 Series	
831-3209/007-000	123	855-4105/250-101	227	857-819	204	862-482	97
831-3602	123	855-4105/400-101	227	857-820	202	862-503	97
				857-979	204	862-504	97
831-3609	123	855-5001/250-001	227	857-980	205	862-505	97
831-3622	123	855-5001/400-000	227	857-981	209	862-515	97
		855-5001/600-000	227	857-982	209	862-525	97
831-3629	123	855-5001/1000-000	227	857-986	209	862-532	97
		855-5005/400-001	227			862-533	97
852 Series		855-5005/600-000	227	858 Series		862-534	97
		855-5005/1000-000	227	858-100	214	862-552	97
852-101	184	855-5101/1000-000	227	858-110	214	862-562	97
852-102	184	855-5105/1000-000	227	858-150	214	862-593	97
852-103	184	855-8001	229	858-151	214	862-594	97
852-103/040-000	184	855-8002	229	858-152	214		
852-111	184	855-8003	229	858-153	214	862-603	97
852-112	184	855-8004	229	858-154	214	862-604	97
852-201/040-002	184			858-304	214	862-605	97
852-201/107-002	184	855-9100/500-000	229	858-314	214	862-615	97
852-201/107-030	184	855-9100/2000-000	229	858-324	214	862-625	97
852-303	184	855-9300/500-000	229	858-354	214	862-632	97
852-1102	184	855-9300/2000-000	229	858-355	214	862-633	97
852-1111	184	855-9900	226	858-355	214	862-634	97
852-1112	184	855-9910	226	858-402	214	862-652	97
852-1200	184	855-9927	228	858-507	214	862-662	97
852-1210	184			858-508	214	862-693	97
852-1280	184	857 Series		858-517	214	862-694	97
852-1305	184	857-303	208	858-518	214		
852-9101	184	857-304	208	858-528	214	862-1503	97
855 Series		857-305	208	859 Series		862-1504	97
		857-306	208	859-302	210	862-1505	97
855-301/050-103	226	857-314	208	859-303	210	862-1515	97
855-301/060-101	226	857-354	208	859-304	210	862-1525	97
855-301/075-201	226	857-357	208	859-306	210	862-1532	97
855-301/100-201	226	857-358	208	859-314	210	862-1533	97
855-301/150-501	226	857-359	208	859-317	210	862-1534	97
855-301/200-501	226	857-364	208	859-318	210	862-1552	97
855-301/250-501	226	857-367	208	859-353	210	862-1562	97
855-301/400-1001	226	857-368	208	859-354	210	862-1593	97
855-301/600-1001	226	857-369	208	859-355	210	862-1594	97
855-305/050-103	226	857-400	200	859-357	210	862-1603	97
855-305/060-101	226	857-401	200	859-358	210	862-1604	97
855-305/075-201	226	857-402	200	859-359	210	862-1605	97
855-305/100-201	226	857-409	200	859-360	210	862-1615	97
855-305/150-501	226	857-411	200	859-367	210	862-1625	97
855-305/200-501	226	857-412	200	859-368	210	862-1632	97
855-305/250-501	226	857-413	200	859-384	210	862-1633	97
855-305/400-1001	226	857-414	200	859-386	210	862-1634	97
855-305/600-1001	226	857-415	200	859-390	210	862-1652	97
		857-416	200	859-391	210	862-1662	97
855-401/400-501	226	857-420	200	859-392	210	862-1693	97
855-401/600-501	226	857-421	200	859-393	210	862-1694	97
855-405/250-501	226	857-423	200	859-394	210		
855-405/400-501	226	857-450	200	859-397	210	862-2503	97
855-501/1000-1001	226	857-451	200	859-398	210	862-2504	97
855-505/400-1001	226	857-452	200	859-399	210	862-2505	97
855-505/600-1001	226					862-2515	97
855-505/800-1001	226	857-500	204			862-2525	97

Item Number Index

Item No.	Page	Item No.	Page	Item No.	Page	Item No.	Page
Series 862		887 Series		2000 Series		2001 Series	
862-2532	97	887-169	290	2000-2141	25	2001-433	26
862-2533	97	890 Series		2000-2201	36		
862-2534	97	890-111	138	2000-2201/099-000	36	2001-440	26
862-2552	97	890-131	138	2000-2202	36	2001-511	26
862-2562	97	890-202	138	2000-2202/099-000	36	2001-549	26
862-2593	97	890-203	138	2000-2203	36	2001-1201	26
862-2594	97	890-204	138	2000-2203/099-000	36	2001-1202	26
862-2603	97	890 Series		2000-2204	36	2001-1203	26
862-2604	97	890-205	138	2000-2204/099-000	36	2001-1204	26
862-2605	97	890-212	138	2000-2207	36	2001-1205	26
862-2615	97	890-213	138	2000-2208	36	2001-1206	26
862-2625	97	890-214	138	2000-2209	36	2001-1207	26
862-2632	97	890-215	138	2000-2217	36	2001-1208	26
862-2633	97	890-222	138	2000-2217/099-000	36	2001-1211/1000-411	26
862-2634	97	890-223	138	2000-2218	36	2001-1301	26
862-2652	97	890-224	138	2000-2218/099-000	36	2001-1302	26
862-2662	97	890-225	138	2000-2227	36	2001-1303	26
862-2693	97	890-232	138	2000-2227/099-000	36	2001-1304	26
862-2694	97	890-233	138	2000-2228	36	2001-1305	26
		890-234	138	2000-2228/099-000	36	2001-1306	26
862-8503	97	890-235	138	2000-2231	36	2001-1307	26
862-8504	97	890-502	138	2000-2231/099-000	36	2001-1308	26
862-8505	97	890-503	138	2000-2232	36	2001-1311/1000-411	26
862-8515	97	890-504	138	2000-2232/099-000	36	2001-1321/1000-434	26
862-8525	97	890-505	138	2000-2233	36	2001-1401	26
862-8533	97	890-512	138	2000-2233/099-000	36	2001-1402	26
862-8534	97	890-513	138	2000-2234	36	2001-1403	26
862-8593	97	890-514	138	2000-2234/099-000	36	2001-1404	26
862-8594	97	890-515	138	2000-2237	36	2001-1405	26
862-8603	97	890-702	139	2000-2238	36	2001-1406	26
862-8604	97	890-703	139	2000-2239	36	2001-1407	26
862-8605	97	890-704	139	2000-2247	36	2001-1408	26
862-8615	97	890-705	139	2000-2247/099-000	36	2001-1411/1000-411	26
862-8625	97	890-712	139	2000-2248	36	2001-1411/1000-434	26
862-8633	97	890-713	139	2000-2248/099-000	36	2001-1441	26
862-8634	97	890-714	139	2000-2257	36		
862-8693	97	890-715	139	2000-2257/099-000	36	2002 Series	
862-8694	97	890-722	139	2000-2258	36	2002-115	27
		890-723	139	2000-2258/099-000	36	2002-116	236
862-9503	97	890-724	139	2000-2291	36	2002-121	37
862-9504	97	890-725	139	2000-2292	36	2002-131	38
862-9505	97	890-732	139	2000-5310/101-000	65	2002-131	38
862-9515	97	890-732	139	2000-5310/102-000	65	2002-161	249
862-9525	97	890-732	139	2000-5310/1101-951	65	2002-171	27
862-9533	97	890-732	139	2000-5310/1102-950	65	2002-172	27
862-9534	97	890-732	139	2000-5311	63	2002-191	39
862-9593	97	890-733	139	2000-5311/1101-951	63	2002-192	39
862-9594	97	890-734	139	2000-5311/1102-950	63	2002-194	39
862-9603	97	890-735	139	2000-5317/101-000	65		
862-9604	97	2000 Series		2000-5317/102-000	65	2002-400	27
862-9605	97	2000-115	25	2000-5317/1101-951	65	2002-401	45
862-9615	97	2000-121	36	2000-5317/1102-950	65	2002-402	27
862-9625	97	2000-402	25	2000-5352	63		
862-9633	97			2000-5352/1102-953	63	2002-410	27
862-9634	97	2000-410	25	2000-5357/101-000	65	2002-405/011-000	27
862-9693	97	2000-405/011-000	25	2000-5357/102-000	65	2002-406/020-000	27
862-9694	97	2000-406/020-000	25	2000-5372	63	2002-423	27
		2000-433	25	2000-5372/1102-953	63	2002-433	27
870 Series				2000-5377/101-000	65		
870-101	84	2000-440	25	2000-5377/102-000	65	2002-440	27
870-107	84			2000-5391	63	2002-472	27
870-108	84	2000-440	25	2000-5410	64		
870-118	84	2000-492	36	2000-5410/1101-951	64	2002-482	27
870-119	84	2000-493/000-012	36	2000-5410/1102-950	64	2002-492	37
870-131	84	2000-1201	25	2000-5417	64	2002-492/000-012	37
870-138	84			2000-5417/1101-951	64	2002-493	38
870-148	84	2000-1207	25	2000-5417/1102-950	64	2002-493/000-012	38
870-149	84	2000-1291	25	2000-5457	64		
870-151	84	2000-1292	25	2000-5457/1102-953	64	2002-511	28
870-157	84			2000-5477	64	2002-549	28
870-158	84	2000-1301	25	2000-5477/1102-953	64	2002-611	27
870-168	84			2000-5491	64	2002-649	27
870-169	84	2000-1307	25	2001 Series		2002-800	236
		2000-1391	25	2001-115	26	2002-800/1000-410	58
		2000-1392	25	2001-171	26	2002-800/1000-411	58
		2000-1401	25	2001-402	26	2002-800/1000-541	58
						2002-800/1000-542	58
873-902	108	2000-1407	25	2001-410	26	2002-800/1000-836	58
873-903	108	2000-1491	25			2002-810	236
873-953	108	2000-1492	25	2001-405/011-000	26	2002-820	236
						2002-880	236

Item No.	Page	Item No.	Page	Item No.	Page	Item No.	Page
2002 Series		2002 Series		2002 Series		2003 Series	
2002-880/1000-411	28	2002-1801	47	2002-2672	58	2003-7646	41
2002-880/1000-541	28	2002-1802	47	2002-2691	58	2003-7649	41
2002-880/1000-542	28	2002-1804	47	2002-2692	58	2003-7650	41
2002-880/1000-836	28	2002-1811	47	2002-2951	59	2003-7651	41
2002-991	45	2002-1811/1000-541	47	2002-2952	59	2003-7659	41
2002-992	45	2002-1811/1000-542	47	2002-2954	59	2003-7692	41
2002-1091	58	2002-1811/1000-836	47	2002-2958	59		
2002-1092	58	2002-1811/1000-867	47	2002-2959	59		
2002-1201	27	2002-1861	48	2002-2971	59		
		2002-1871	47	2002-2972	59		
2002-1208	27	2002-1871/401-000	47	2002-2974	59	2004 Series	
2002-1211/1000-410	60	2002-1872	47	2002-2991	59	2004-115	29
2002-1211/1000-411	60	2002-1872/401-000	47	2002-2992	59	2004-171	29
2002-1291	26	2002-1874	47			2004-172	29
2002-1292	26	2002-1874/401-000	47			2004-402	29
2002-1293	26	2002-1881	47				
2002-1294	26	2002-1891	47	2002-3201	38	2004-410	29
		2002-1892	47	2002-3203	38	2004-405/011-000	29
2002-1301	27	2002-1981	45	2002-3204	38	2004-406/020-000	29
				2002-3207	38	2004-433	29
2002-1308	27			2002-3208	38		
2002-1311/1000-410	60	2002-2201	37	2002-3209	38	2004-440	29
2002-1311/1000-411	60	2002-2202	37	2002-3211/1000-410	61	2004-511	29
2002-1321/1000-413	60	2002-2203	37	2002-3211/1000-411	61	2004-549	29
2002-1321/1000-434	60	2002-2204	37	2002-3211/1000-675	61	2004-911	48
2002-1391	26	2002-2207	37	2002-3211/1000-676	61	2004-911/1000-541	48
2002-1392	26	2002-2208	37	2002-3212/1000-673	61	2004-911/1000-542	48
2002-1393	26	2002-2209	37	2002-3212/1000-674	61	2004-911/1000-836	48
2002-1394	26	2002-2211/1000-410	61	2002-3217	38		
		2002-2211/1000-411	61	2002-3218	38	2004-1201	29
2002-1401	27	2002-2213/1000-487	61	2002-3221/1000-413	61	2004-1202	29
		2002-2213/1000-488	61	2002-3221/1000-434	61	2004-1203	29
2002-1408	27	2002-2214/1000-489	61	2002-3227	38	2004-1204	29
2002-1411/1000-410	60	2002-2214/1000-490	61	2002-3228	38	2004-1205	29
2002-1411/1000-411	60	2002-2214/1000-491	61	2002-3228	38	2004-1206	29
2002-1421/1000-413	60	2002-2214/1000-492	61	2002-3231	38	2004-1207	29
2002-1421/1000-434	60	2002-2217	37	2002-3233	38	2004-1208	29
2002-1441	27	2002-2221/1000-413	61	2002-3234	38	2004-1208	29
2002-1491	26	2002-2221/1000-434	61	2002-3237	38	2004-1291	29
2002-1492	26	2002-2227	37	2002-3238	38	2004-1292	29
2002-1493	26	2002-2231	37	2002-3239	38	2004-1293	29
2002-1494	26	2002-2232	37	2002-3247	38	2004-1294	29
		2002-2233	37	2002-3248	38	2004-1301	29
		2002-2234	37	2002-3257	38	2004-1302	29
2002-1601	45	2002-2237	37	2002-3258	38	2004-1303	29
2002-1602	45	2002-2238	37	2002-3291	38	2004-1304	29
2002-1604	45	2002-2239	37	2002-3292	38	2004-1305	29
2002-1611	45	2002-2247	37			2004-1306	29
2002-1611/1000-541	45	2002-2257	37	2002-4101	39	2004-1307	29
2002-1611/1000-542	45	2002-2291	37	2002-4111	39	2004-1308	29
2002-1611/1000-836	45	2002-2292	37	2002-4127	39	2004-1391	29
2002-1611/1000-867	45			2002-4131	39	2004-1392	29
2002-1661	48	2002-2401	37	2002-4141	39	2004-1393	29
2002-1671	45	2002-2402	37	2002-4157	39	2004-1394	29
2002-1671/401-000	45	2002-2403	37	2002-4191	39		
2002-1672	45	2002-2404	37	2002-4192	39	2004-1401	29
2002-1672/401-000	45	2002-2407	37			2004-1402	29
2002-1674	45	2002-2408	37	2002-6301	28	2004-1403	29
2002-1674/401-000	45	2002-2409	37	2002-6302	28	2004-1404	29
2002-1681	45	2002-2417	37	2002-6304	28	2004-1405	29
2002-1691	45	2002-2427	37	2002-6307	28	2004-1406	29
2002-1692	45	2002-2431	37	2002-6308	28	2004-1407	29
		2002-2432	37	2002-6391	28	2004-1408	29
		2002-2433	37	2002-6392	28	2004-1491	29
2002-1701	46	2002-2434	37	2002-6401	28	2004-1492	29
2002-1702	46	2002-2437	37	2002-6402	28	2004-1493	29
2002-1704	46	2002-2438	37	2002-6404	28	2004-1494	29
2002-1711	46	2002-2439	37	2002-6407	28		
2002-1711/1000-541	46	2002-2447	37	2002-7111	42	2005 Series	
2002-1711/1000-542	46	2002-2457	37	2002-7114	42	2005-7300	41
2002-1711/1000-836	46	2002-2491	37	2002-7192	42	2005-7641	41
2002-1711/1000-867	46	2002-2492	37	2002-7211	42	2005-7642	41
2002-1761	48			2002-7214	42	2005-7645	41
2002-1771	46			2002-7292	42	2005-7646	41
2002-1771/401-000	46	2002-2611	58			2005-7649	41
2002-1772	46	2002-2611/1000-541	58	2003 Series		2005-7692	41
2002-1772/401-000	46	2002-2611/1000-542	58	2003-911	48		
2002-1774	46	2002-2611/1000-836	58	2003-911/1000-923	48		
2002-1774/401-000	46	2002-2612	58				
2002-1781	46	2002-2661	58	2003-7300	41		
2002-1791	46	2002-2662	58	2003-7640	41		
2002-1792	46	2002-2667	58	2003-7641	41		
		2002-2671	58	2003-7642	41		
				2003-7645	41		

Item Number Index

Item No.	Page	Item No.	Page	Item No.	Page	Item No.	Page
2006 Series		2006 Series		2016 Series		2020 Series	
2006-115	30	2006-8664	51	2016-100	32	2020-2239	67
2006-191	51	2006-8671	51	2016-115	32	2020-2247	67
2006-401	49	2006-8674	51	2016-402	32	2020-2257	67
2006-401/000-005	49	2006-8691	51	2016-403	32	2020-2291	67
2006-402	30	2006-8692	51	2016-404	32	2020-2292	67
2006-403	30	2007 Series		2016-405	32	2022 Series	
2006-404	30	2007-8442	56	2016-405/011-000	32	2022-100	68
2006-405	30			2016-433	32	2022-101	68
2006-405/011-000	30	2007-8448	56	2016-434	32		
2006-433	30	2007-8801	56	2016-435	31	2022-115	68
2006-434	30	2007-8807	56	2016-499	32	2022-102/999-953	69
2006-435	30	2007-8811	56	2016-511	32	2022-103/000-036	68
2006-451	49	2007-8821	56	2016-549	32		
2006-499	31	2007-8873	57	2016-1201	32	2022-115/000-036	68
2006-511	30	2007-8876	57	2016-1202	32	2022-103/000-037	68
2006-549	30	2007-8876	57	2016-1204	32		
2006-991	50	2007-8891	56	2016-1207	32	2022-115/000-037	68
2006-992	50	2007-8892	56	2016-1208	32	2022-103/999-953	69
2006-1201	30	2007-8892	56	2016-1208	32	2022-104/999-953	69
2006-1202	30	2007-8893	56	2016-1291	32	2022-105/999-953	69
2006-1204	30	2007-8894	56	2016-1292	32	2022-106/999-953	69
2006-1207	30	2007-8899	56	2016-1301	32	2022-107/999-953	69
2006-1208	30	2009 Series		2016-1302	32	2022-108/999-953	69
2006-1291	30	2009-110	244	2016-1304	32	2022-141	67
2006-1292	30	2009-113	244	2016-1307	32	2022-142	67
2006-1301	30	2009-114	244	2016-1391	32	2022-151	67
2006-1302	30	2009-115	244	2016-1392	32	2022-152	67
2006-1304	30	2009-135	244	2016-7111	42	2022-1201	68
2006-1307	30	2009-145	244	2016-7114	42	2022-1201/999-953	69
2006-1391	30	2009-163	249	2016-7192	42	2022-1202	68
2006-1392	30	2009-174	25	2016-7601	43	2022-1204	68
2006-1601	49	2009-180	250	2016-7604	43	2022-1204/999-953	69
2006-1604	49	2009-182	25	2016-7607	43	2022-1207	68
2006-1611	50	2009-191	249	2016-7692	43	2022-1207/999-953	69
2006-1611/1000-541	50	2009-192	249	2016-7711	43	2022-1291	68
2006-1611/1000-542	50	2009-193	249	2016-7714	43	2022-1292	68
2006-1611/1000-836	50	2009-196	249	2016-7792	43	2022-1301	68
2006-1611/1000-867	50	2009-198	249	2020 Series		2022-1301/999-953	69
2006-1621	50	2009-304	41	2020-100	67	2022-1302	68
2006-1621/1000-541	50	2009-305	41	2020-102	67	2022-1304	68
2006-1621/1000-542	50	2009-309	253			2022-1304/999-953	69
2006-1621/1000-836	50	2009-310	253	2020-115	67	2022-1307	68
2006-1621/1000-867	50	2009-412	26	2020-202	67	2022-1307/999-953	69
2006-1621/1000-859	50	2009-414	26			2022-1391	68
2006-1631	50	2009-416	26	2020-215	67	2022-1392	68
2006-1631/099-000	50	2009-515	244	2020-1201	67	2022-1401	68
2006-1631/1000-541	50	2009-615	244	2020-1204	67	2022-1401/999-953	69
2006-1631/1000-542	50	2010 Series		2020-1207	67	2022-1402	68
2006-1631/1000-836	50	2010-100	31	2020-1207	67	2022-1404	68
2006-1631/1000-859	50	2010-115	31	2020-1291	67	2022-1404/999-953	69
2006-1631/1000-867	50	2010-402	31	2020-1292	67	2022-1407	68
2006-1631/1099-541	50	2010-403	31	2020-1301	67	2022-1407/999-953	69
2006-1631/1099-542	50	2010-404	31	2020-1304	67	2022-1491	68
2006-1631/1099-836	50	2010-405	31	2020-1307	67	2022-1492	68
2006-1631/1099-859	50	2010-405/011-000	31	2020-1391	67	2022-2201	68
2006-1631/1099-867	50	2010-433	31	2020-1392	67	2022-2201/999-953	69
2006-1671	49	2010-434	31	2020-1401	67	2022-2202	68
2006-1671/1000-848	49	2010-435	31	2020-1404	67	2022-2203	68
2006-1671/1000-849	49	2010-511	31	2020-1407	67	2022-2203	68
2006-1671/1000-850	49	2010-549	31	2020-1491	67	2022-2204	68
2006-1671/1000-851	49	2010-1201	31	2020-1492	67	2022-2207	68
2006-1674	49	2010-1202	31	2020-2201	67	2022-2207/999-953	69
2006-1681	49	2010-1204	31	2020-2202	67	2022-2208	68
2006-1681/1000-413	49	2010-1207	31	2020-2203	67	2022-2209	68
2006-1681/1000-414	49	2010-1208	31	2020-2204	67	2022-2217	68
2006-1681/1000-429	49	2010-1291	31	2020-2207	67	2022-2227	68
2006-1681/1000-434	49	2010-1292	31	2020-2208	67	2022-2231	68
2006-1681/1000-435	49	2010-1301	31	2020-2209	67	2022-2232	68
2006-1681/1000-449	49	2010-1302	31	2020-2217	67	2022-2233	68
2006-1691	49	2010-1304	31	2020-2217	67	2022-2234	68
2006-1692	49	2010-1307	31	2020-2227	67	2022-2234/999-953	69
2006-7111	42	2010-1391	31	2020-2231	67	2022-2237	68
2006-7114	42	2010-1392	31	2020-2232	67	2022-2238	68
2006-7192	42	2010-1392	31	2020-2233	67	2022-2239	68
2006-7300	42	2010-1392	31	2020-2237	67	2022-2247	68
2006-8401	51	2010-1392	31	2020-2238	67	2022-2257	68
2006-8601	51					2022-2291	68
2006-8604	51					2022-2292	68
2006-8661	51						

Item No.	Page	Item No.	Page	Item No.	Page	Item No.	Page
2059 Series		2091 Series		2231 Series		2721 Series	
2059-189	133	2091-1402	111	2231-202/026-000	122	2721-102/008-000	118
2059-301/998-403	133						
		2091-1412	111	2231-216/026-000	122	2721-120/008-000	118
2059-303/998-403	133	2091-1422	111	2231-202/031-000	122	2721-102/026-000	118
2060 Series		2092 Series		2273 Series		2734 Series	
2060-189	133	2092-1152	113	2273-202	106	2734-102	116
2060-451/998-404	133			2273-203	106	2734-124	116
		2092-1162	113	2273-204	106	2734-102/031-000	116
2060-453/998-404	133	2092-1172	113	2273-205	106		
2060-471/998-404	133			2273-208	106	2734-124/031-000	116
		2092-1182	113	2273-500	107	2734-102/037-000	116
2060-473/998-404	133	2092-1352	113	2706 Series			
2060-852/998-404	133			2706-102	130	2734-124/037-000	117
2060-951/028-000	133	2092-1362	113			2734-220	117
		2092-1372	113	2706-112	130		
2060-954/028-000	133			2706-152	130	2734-202/031-000	117
2060-962/028-000	133	2092-1382	113			2734-202/031-000	117
2060-1451/998-404	133	2092-1600	113	2706-202	131		
						2734-220/031-000	117
2060-1453/998-404	133	2092-1603	113	2706-212	131	2734-202/037-000	117
2060-1471/998-404	133	2092-1600/002-000	113	2706-252	131		
						2734-220/037-000	117
2060-1473/998-404	133	2092-1603/002-000	113	2706-262	131	2759 Series	
2060-1852/998-404	133	2092-1630	113	2706-302	132	2759-101/1110-2002	146
2060-1872/998-404	133	2092-3152	113			2759-101/1110-2010	146
2061 Series		2092-3155	113	2706-312	132	2759-101/1110-2015	146
2061-189	133	2092-3172	113			2759-101/1110-2020	146
2061-601/998-404	133			2706-162	130	2759-101/1110-3000	146
		2092-3175	113	2706-202	131	2759-101/1110-4000	146
2061-603/998-404	133	2092-3352	113			2857 Series	
2061-621/998-404	133			2706-212	131	2857-101	237
		2092-3355	113	2706-252	131	2857-102	237
2061-623/998-404	133	2092-3372	113			2857-103	237
2061-1601/998-404	133			2706-262	131	2857-121	237
		2092-3375	113	2706-302	132	2857-122	237
2061-1603/998-404	133	2092-3600	113			2857-123	237
2061-1621/998-404	133			2706-312	132	2857-124	237
		2092-3603	113			2857-191/3140-000	237
2061-1623/998-404	133	2092-3600/002-000	113	2716-102	131	2857-192/3140-000	237
2061-1641/998-404	133					2857-193/3140-000	237
		2092-3603/002-000	113	2716-108	131	2857-194/3140-000	237
2061-1643/998-404	133			2716-152	131		
2061-1661/998-404	133	2231 Series		2716-158	131	2857-401	200
		2231-102/008-000	119	2716-202	132	2857-533	204
2061-1663/998-404	133					2857-534	204
2091 Series		2231-124/008-000	119	2716-208	132	2857-550	202
2091-1102	111	2231-102/026-000	119			2857-900	204
				2716-252	132		
2091-1112	111	2231-124/026-000	119				
2091-1102/002-000	111	2231-102/031-000	119	2716-258	132		
2091-1112/002-000	111	2231-124/031-000	119				
2091-1122	111	2231-102/037-000	119				
2091-1132	111	2231-124/037-000	119				
2091-1152	113	2231-102/102-000	119				
2091-1162	113	2231-124/102-000	119				
2091-1172	113	2231-202/008-000	122				
2091-1182	113	2231-216/008-000	122				
2091-1302	111						
		2231-102/008-000	118				
2091-1308	111						
2091-1322	111	2231-102/008-000	118				
2091-1328	111	2231-102/008-000	118				
2091-1352	113						
		2231-102/008-000	118				
2091-1362	113						
2091-1372	113	2231-102/008-000	118				
2091-1382	113	2231-102/008-000	118				

WAGO Worldwide

Companies and Representatives

Algeria

please contact WAGO France

Argentina

Bruno Schillig S.A.
Arenales 4030, B1604CFD
Florida, PBA
Phone +54 11 4730 1100
Fax +54 11 4761 7244
wago@schillig.com.ar

Austria

WAGO Kontakttechnik Ges.m.b.H.
Europaring F15 602
Campus 21
2345 Brunn am Gebirge
Phone +43 1 6150780
Fax +43 1 6150775
wago-at@wago.com

Azerbaijan

AZ Technics LTD
Zulfi V. Alizade
Y.Safarov str.33, AZ1025,
Baku
Republic of Azerbaijan
Phone +994 50 210 24 49
Fax +994 12 496 83 34
info@AZtechnics.az

Australia

WAGO Pty. Ltd.
2-4 Overseas Drive
Noble Park Victoria 3174
Phone +61 03 8791 6300
Fax +61 03 9701 0177
sales.anz@wago.com

Bangladesh

please contact WAGO India

Belarus

OOO FEK
pr-t Pushkina 29-B
220015 Minsk
Phone +375 17 2102189
Fax +375 17 2102189
wago@fek.by

UP ATAVA

ul. Denisovskaya, 47, office 1
220006 Minsk
Phone +375 17 2054015
Fax +375 17 2851759

Belgium

WAGO BeLux nv
Excelsiorlaan 11
1930 Zaventem
Phone +32 2 717 9090
Fax +32 2 717 9099
info-be@wago.com

Bolivia

ISOTEK S.R.L.
Zona Casco Viejo
Calle Isso #578, B/San Roque
Santa Cruz
Phone +591 721 000 27

Bosnia and Herzegovina

please contact WAGO Bulgaria

Brazil

WAGO Eletroeletrônicos Ltda
Rua Américo Simões 1470
São Roque da Chave
Itupeva SP Brasil 13295-000
Phone +55 11 4591 0199
Fax +55 11 4591 0190
info.br@wago.com

Bulgaria

WAGO Kontakttechnik GmbH & Co. KG/
Representative Office Sofia
Business Center Serdika
2E Akad. Ivan Geshov Blvd.
Building 1, Floor 4, Office 417
1330 Sofia
Phone +359 2 489 46 09/10
Fax +359 2 928 28 50
info-BG@wago.com

Canada

please contact WAGO USA

Chile

Desimat Chile
Av Puerto Vespuccio 9670
Pudahuel Santiago
Phone +56 2 747 0152
Fax +56 2 747 0153
ventaschile@desimat.cl

China

WAGO Electronic (Tianjin) Co., Ltd.
No.5, Quan Hui Road
Wuqing Development Area
Tianjin 301700
Phone +86 22 5967 7688
Fax +86 22 5961 7668
info-cn@wago.com

Colombia

T.H.L. Ltda.
Cra. 49 B # 91-33
Bogotá
Phone +57 1 621 85 50
Fax +57 1 621 60 28
ventas-thl@thl-ltdda.com

Croatia

M.B.A. d.o.o.
Frana Supila 5
51211 Matulji
Phone +385 51 275-736
Fax +385 51 275-066
mba@ri.htnet.hr

MICROSTAR d.o.o.

Siget 18 b
10020 Zagreb
Phone +385 1 3647 849
Fax +385 1 3636 662
wago@microstar.hr

Czech Republic

WAGO Elektro spol. sr. o.
Rozvodova 1116/36
143 00 Praha 4 - Modřany
Phone +420 261 090 143
Fax +420 261 090 144
info.cz@wago.com
wago-cz@wago.com

Denmark

WAGO Denmark A/S
Lejrvej 17
3500 Værløse
Phone +45 44 357 777
info.dk@wago.com

Egypt

IBN Engineering Instrumentation & Control
71 a El Shaheed Ahmed Hamdi St.
King Faisal, Giza
Phone +20 2 721 4350
Fax +20 2 722 1709
sales@ibnengineering.com

Ecuador

ECUAINSETEC CIA LTDA
Yugoslavia N34-110 y Azuay
Quito
Phone +593 2 24 50 475
Fax +593 2 22 51 242
g.castro@ecuainsetec.com.ec

Estonia

Eltarko OÜ
Laki 14 - 502
10621 Tallinn
Phone +372 651 7731
Fax +372 651 7786
andres@eltarko.ee

Finland

WAGO Finland Oy
Vellamonkatu 30 B
00550 Helsinki
Phone +358 9 7744 060
Fax +358 9 7744 0660
tilaus@wago.fi

France

WAGO Contact SAS
Paris Nord 2
83 Rue des Chardonnerets
B.P. 55065 - Tremblay en France
95947 - ROISSY CDG CEDEX
Phone +33 1 4817 2590
Fax +33 1 4863 2520
info-fr@wago.com

Germany

WAGO Kontakttechnik GmbH & Co. KG
Postfach 28 80, 32385 Minden
Hansastraße 27
32423 Minden
Phone +49 571 887-0
Fax +49 571 887-844169
info@wago.com

Germany

WAGO Kontakttechnik GmbH & Co. KG
Waldstraße 1
99706 Sondershausen
Phone +49 3632 659-0
Fax +49 3632 659-100
info@wago.com

Great Britain

WAGO Limited
Triton Park, Swift Valley Industrial Estate
RUGBY
Warwickshire, CV21 1SG
Phone +44 1788 568 008
Fax +44 1788 568 050
uksales@wago.com

Greece

PANAGIOTIS SP. DIMOULAS
DIMOULAS AUTOMATIONS
Kritis Str. 26
10439 Athens
Phone +30 210 883 3337
Fax +30 210 883 4436
wago.info@dimoulas.com.gr

Honduras

CILASAS S.A. de C.V.
Barrio Los Andes
7 Calle entre 14 y 15 Ave. N.O.
P.O. Box. 1061
San Pedro Sula
Phone +504 2557 1146/7
Fax +504 2557 1149

Hong Kong

National Concord Eng., Ltd.
Unit A-B, 5/F.
Southeast Industrial Building
611-619 Castle Peak Road
Tsuen Wan, N.T.
Phone +852 2429 2611
Fax +852 2429 2164
sales@nce.com.hk

Hungary

WAGO Hungária KFT
Ipari Park, Gyár u. 2
2040 Budapest
Phone +36 23 502-170
Fax +36 23 502-166
info.hu@wago.com

Iceland

S. Gudjonsson ehf.
Audbrekku 9-11
202 Kopavogur
Phone +354 520-4500
Fax +354 520-4501
export@wago.com

India

WAGO Private Limited
C-27, Sector-58, Phase-III
Noida-201 301
Gautam Budh Nagar (U.P)
Phone +91 120 438 8700
Fax +91 120 438 8799
info.india@wago.com

Indonesia

please contact WAGO Singapore

Iraq

please contact WAGO Middle East

Ireland

Drives & Controls
Unit F4, Riverview Business Park
Nangor Road
Dublin 12
Phone +353 1 4604474
Fax +353 1 4604507
info@drivesandcontrols.ie

Israel

Comtel Israel Electronic Solutions Ltd.
Bet Hapaamon
20 Hataas Street
P.O. Box 66
44425 Kefar-Saba
Phone +972 9 76 77 240
Fax +972 9 76 77 243
sales@comPhoneco.il

Italy

WAGO ELETTRONICA SRL a Socio Unico
Via Parini 1
40033 Casalecchio di Reno (BO)
Phone +39 051 6132112
Fax +39 051 6272174
info-ita@wago.com

Japan

WAGO Co. of JAPAN Ltd.
Kinsicho Prime Tower
5-7, Kameido, Koto-Ku
Tokyo 136-0071
Phone +81 3 5627 2059
Fax +81 3 5627 2055
info-jp@wago.com

Jordan

please contact WAGO Middle East

Kazakhstan

TOO INTANT
232/2, Ryskulov avenue
050061 Almaty
Phone +7 727 356 52 91/92/93
Fax +7 727 327 14 92/93
ee@intant.net
ees_sm1@intant.net

TOO Technik-Trade

ul. i. A. Protosanova, 81
070004 Ust-Kamenogorsk
Phone +7 7232 254 064
Fax +7 7232 253 251
info@technik.kz

Korea

WAGO Korea Co., Ltd.
Room 205 AnyangMegaValley,
268, Hagui-ro, Dongan-gu, Anyang-si,
Gyeonggi-do, 14056, South Korea
Phone +82 31 421 9500
info.korea@wago.com

Kosovo

please contact WAGO Bulgaria

Latvia

INSTABALT LATVIA SIA
Vestienas iela 6
Riga, LV-1035
Phone +371 6790 1188
Fax +371 6790 1180
info@instabalt.lv

Lebanon

Gemayel Trading & Contracting
Antonins Project
P.O. BOX 70-1096
Antelias
Lebanon
Phone +961 4 521 029
Fax +961 4 521 029
info@uae.com

Lithuania

INSTABALT LIT UAB
Savanorių 187
Vilnius, 2053
Phone +370 52 322 295
Fax +370 52 322 247
info@instabalt.lt

Luxembourg

please contact WAGO Belgium

Macedonia

please contact WAGO Bulgaria

Kompjunet Inzenering
Vladimir Komarov 1A-3/9
1000 Skopje
Republic of Macedonia
Phone +389 2 521 12 00
Phone +389 2 246 11 08

Malaysia

WAGO Representative Office Malaysia
No 806, Block A4, Leisure Commerce Square,
No 9, Jalan PJS 8/9, 46150 Petaling Jaya,
Selangor Darul Ehsan, Malaysia
Phone +60 3 7877 1776
Fax +60 3 7877 2776
kian.guan.tan@wago.com

HPH Materials (M) Sdn Bhd

No. 4, Jalan Nilam 1/6
Suban Hi-Tech Industrial Park
40000 Shah Alam
Selangor, D.E. Malaysia
Phone +60 3 5638 2213
Fax +60 3 5638 8213
info@hphmaterials.com

Maldives

please contact WAGO India

Mexico

WAGO SA de CV
Av. Del Marques 38 Bodega 3
P. I. Bernardo Quintana
76246 El Marques, Querétaro
Phone +52 442 221 5946
Fax +52 442 221 5063
info.mx@wago.com

Moldova

Electroservice Slavinski T.T.
str. Bolgarskaia 9, office 6
2001 Kishinev
Phone +373 22 274427
Fax +373 22 224481
es@es.mldnet.com

Morocco

Automatisme & Connection Maroc
23, Rue Bourd, 2ème étage, appt4
Roche Noire
20300 Casablanca
Phone +212 522 24 21 72/73
Fax +212 522 24 21 75
info-fr@wago.com

Nepal

please contact WAGO India

Netherlands

WAGO Nederland B.V.
Laan van de Ram 19
7234 BW APELDOORN
Phone +31 55 36 83 500
Fax +31 55 36 83 599
info-nl@wago.com

New Zealand

please contact WAGO Australia

NHP NZ

7 Lockhart Place
Mt Wellington
New Zealand
Phone +64 9 2761967
Fax +64 9 2761992
export@wago.com

Nigeria

GIL Automations Ltd.
Daily Times Complex
2 Lateef Jakande Rd., Agidingbi
100271 Ikeja, Lagos State
Phone +234 17132672335
sales@gilautomation.com

Norway

WAGO Norge AS
Jerikoveien 20
1067 Oslo
Phone +47 22 30 94 50
Fax +47 22 30 94 51
info.no@wago.com

Oman

please contact WAGO Middle East

Pakistan

FuziLogix Automation & Control
Suit No. 14, 5th Floor, Shan Arcade
New Garden Town, Lahore
Pakistan
Phone +92 42 594 1503 - 4
Fax +92 42 585 1431
info@fuzilogix.com

Paraguay

AESA
Av. Madame Lynch
c/Antolin Irala
2309 Asunción
Tel. +59 521674524
info@aesa.com.py

Peru

Manufacturas Eléctricas S.A.
Av O.R. Benavides 1215
15000 Lima
Phone +511 6196200
Fax +511 6196247

Philippines

please contact WAGO Singapore

Poland

WAGO ELWAG sp. z o. o.
ul. Piekna 58 a
50-506 Wrocław
Phone +48 71 3602970
Fax +48 71 3602999
wago.elwag@wago.com

Portugal

MORGADO & CA. LDA - SEDE
Estrada Exterior da
Circunvalação 3558/3560
Apartado 1057
4435 Rio Tinto
Phone +351 22 9770600
Fax +351 22 9770699
geral@morgadocl.pt

Quatar

please contact WAGO Middle East

Romania

WAGO Kontakttechnik GmbH & Co. KG
Representative Office Romania
Sos. Pipera-Tunari nr. 1/1
building 1, 2nd floor
077190 Voluntari, Ilfov
Tel. +40-(0)31 421 85 68
info-RO@wago.com

VDR & Servicii srl

Str. Valeriu Braniște, nr. 60, ap.1, sector 3
Romania
Phone +40 21 3225074/76
Fax +40 21 3225075
office@componente-automatizari.ro

Russia

OOO WAGO Contact Rus
Dmitrovskoe shosse, 157,
bldg. 12/5
127411 Moscow
Russia
Phone +7 495 663-3305
Fax +7 495 663-3308
info.ru@wago.com

OOO Decima

Projesd 4922, d. 4, str. 1
124460 Moscow / Selenograd
Phone +7 495 988 4858
Fax +7 495 988 4858
decima@decima.ru

OOO Prosoft

ul. Profsoznaya, 108
117437 Moscow
Phone +7 495 2340636
Fax +7 495 2340640
info@prosoft.ru

ITC Electronics: Moscow

Radio str. 24
105005 Moscow
Phone +7 495 775 1845
Fax +7 495 775 1848
moscow@itc-electronics.com

WAGO Branch office

Ekaterinburg
Phone +7 343 216 3426

WAGO Branch office

Novosibirsk
Phone +7 383 217 9244

WAGO Branch office

St. Petersburg
Phone +7 812 312 1918

Saudi Arabia

Saudi Electronic Trading Company
(SETRA), P.O. Box 60712
11555-Riyadh
Phone +966 1 2062277
Fax +966 1 2062277
khaled.wafai@setra.com.sa

Serbia

please contact WAGO Bulgaria

Avalon Partners doo

Patrijarha Dimitrija 24
11000 Beograd
Phone +381 11 268 5311
Fax +381 11 268 5311
office@avalon.rs

Sigma doo

Balzakova 3
21000 Novi Sad
Phone +381 21 468 431
Fax +381 21 636 1785
office@sigmadoo.co.rs

Singapore

WAGO Electronic Pte Ltd
No. 10 Upper Aljunied Link #04-04
Singapore 367904
Phone +65 62866776
Fax +65 62842425
info-sing@wago.com

Slovakia

Proelektr spol. s r.o.
Na barine 22
841 03 Bratislava - Lamač
Phone +421 2 4569 2503
info@wago.sk

Slovenia

IC elektronika d.o.o.
Vodovodna cesta 100
1000 Ljubljana
Phone +386 1568 0126
Fax +386 1568 9107
info@ic-elect.si

GENERA d.o.o.

Prevale 10
1236 Trzin
Phone +386 14393050
Fax +386 14393090
genera@genera.si

Slovenia

Elektronabava d.o.o.
Cesta 24 junija 3
1231 Ljubljana
Phone +386 1 58 99 300
Fax +386 1 58 99 409
info@elektronabava.si

South Africa

Shorrock Automation (Pty) Ltd
Postnet Suite # 219
Private Bag X 8, Elardus Park
0047 PRETORIA
Phone +27 12 4500300
Fax +27 12 4500322
sales@shorrock.co.za

Spain

DICOMAT S.L.
Avda. de la Industria, 36
Apartado Correos, 1.178
28108-Alcobendas (Madrid)
Phone +34 91 662 1362
Fax +34 91 661 0089
info@dicomat-asetyc.com

Sweden

WAGO Sverige AB
Tyskland Filial
Box 11 1127, 161 11 BROMMA
Besöksadress: Adolfsbergsv. 31
Phone +46 858410680
Fax +46 858410699
info.se@wago.com

Switzerland

WAGO CONTACT SA
Rte. de l'Industrie 19
Case Postale 168
1564 Domdidier
Phone +41 26 676 75 00
Fax +41 26 676 75 01
info.switzerland@wago.com

Sri Lanka

please contact WAGO India

Syria

Zahabi Co.
8/5 Shouhadaa St., P.O. Box 8262
Aleppo
Phone +963 21 21 22 235 / 6
Fax +963 21 21 22 23 7
info.uae@wago.com

Taiwan R.O.C.

WAGO Contact, Ltd.
5F., No.168, Jiankang Rd
Zhonghe City
Taipei County 23585, Taiwan
Phone +886 2 2225 0123
Fax +886 2 2225 1511
info.taiwan@wago.com

Thailand

WAGO Representative Office Thailand
4th Floor, KS Building
213/6-8 Rachada-Phisek Road
Dingdaeng, Bangkok 10400
Phone +66 2 6935611
Fax +66 2 6935612
warongkon.khankham@wago.com

US Power Distribution Co., Ltd.
4th Floor, KS Building
213/6-8 Rachada-Phisek Road
Dingdaeng, Bangkok 10400
Phone +66 2 2763040
Fax +66 2 2763049
uspower2014@gmail.com

Thailand

Itthirrit Technology Co., Ltd.
Vision Business Park 2 Floor 4
Soi Raminthra 55/8, Watcharapon Road
Tharaeng, Bangkok District
Bangkok Thailand 10220
Tel. +66 2 347 0780
Fax +66 2 347 0772
sales@itthirrittechnology.com

Tunisia

please contact WAGO France

Turkey

WAGO Elektronik Sanayi ve Ticaret
Ltd. Şti.
Yukan Dudullu Mahallesi Bayraktar
Bulvarı
Cad. Hattat Sok. No. 10
34775 Ümraniye - İstanbul
Phone +90 216 472 1133
Fax +90 216 472 9910
info.tr@wago.com

Ukraine

NPP Logicon
Predslavinskaya street, 39, office 303
03150 Kiev
Phone +380 44 5228019
Fax +380 44 2611803
info@logicon.ua

OOO Micropribor

ul. Kotelnikova, 4
03115 Kiev
Phone +380 44 5369386
Fax +380 44 5369387
sales@micropribor.kiev.ua

United Arab Emirates (UAE)

WAGO Middle East (FZC)
SAIF Zone, Q4-282
P.O. Box 120665
Sharjah, UAE
Phone +971 6 5579920
Fax +971 6 5579921
info.uae@wago.com

Uruguay

Fivisa Electricidad
Avda. Uruguay 1274
11100 Montevideo
Phone +59 829 020 808
Fax +59 829 021 230
info@fivisa.com.uy

USA

WAGO CORPORATION
N120 W19129 Freistadt Road
Germantown, WI 53022
Phone +1 262 255 6222
Fax +1 262 255 3232
Toll-Free: 1-800 DIN Rail (346-7245)
info.us@wago.com

Venezuela

PETROBORNAS, C.A.
C.C. PLAZA AEROPUERTO - PISO 1 -
LOCAL P1-B-03
(8015) UNARE - PUERTO ORDAZ -
ESTADO BOLÍVAR
REPÚBLICA BOLIVARIANA DE
VENEZUELA
Phone +58 286 951 3382
Fax +58 286 951 3382
info@petrobornas.com

Vietnam

please contact WAGO Germany
(Minden)

Notes

A large grid of graph paper for taking notes, consisting of 20 columns and 30 rows of small squares.

Notes

A large grid of graph paper for taking notes, consisting of 20 columns and 30 rows of small squares.

Notes

A large grid of graph paper for taking notes, consisting of 20 columns and 30 rows of small squares.

Notes

A large grid of graph paper for taking notes, consisting of 20 columns and 30 rows of small squares.

Notes

A large grid of graph paper for taking notes, consisting of 20 columns and 30 rows of small squares.

WAGO Kontakttechnik GmbH & Co. KG

Postfach 2880 · 32385 Minden
Hansastraße 27 · 32423 Minden
info@wago.com
www.wago.com

Headquarters	0571/887 - 0
Sales	0571/887 - 222
Order Service	0571/887 - 44333
Technical Support	0571/887 - 555
Fax	0571/887 - 844169