

# Related Products: Heavy Duty Auto Drain Series ADH4000

## Easy maintenance

It is possible to maintain without changing existing piping.

## No need for electric power and no waste of air.

Float style drain allows automatic drain discharge without electric power.

## Mounting example

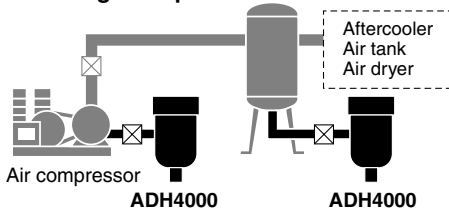

Air compressor

ADH4000

ADH4000

Aftercooler  
Air tank  
Air dryer



Ball valve piping set

Bracket set

## JIS Symbol

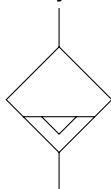

## Specifications

Auto-drain type	Float type
Auto-drain valve type	N.O. (Normally open: Open in the case of pressure loss)
Proof pressure	2.5 MPa
Max. operating pressure	1.6 MPa
Operating pressure range <sup>Note)</sup>	0.05 to 1.6 MPa
Fluid <sup>Note)</sup>	Compressed air
Ambient and Fluid temperature	5 to 60°C (With no condensation) <Corrosive gas, flammable gas and organic solvents are not allowed.>
Max. drain discharge	400 cc/min (Pressure 0.7 MPa, in the case of water)
Weight	1.2 kg (With bracket: 1.3 kg)
Paint color	Light gray



Note) Use for air compressor with flow more than 50 ℓ/min (ANR).

## Accessory (Option)

Description	Part no.	Contents
Bracket set	BM58	Bracket ..... 1 pc. M6 x 10ℓ (Hex. bolt) ..... 2 pcs.
Ball valve piping set	ADH-C400	Ball valve/Rc 1/2 ..... 1 pc. Barrel nipple/R 1/2 ..... 2 pcs. Elbow/Rc 1/2 ..... 1 pc.



Note) The accessories (Option) are shipped unassembled, but packed in the same container.

## How to Order

**ADH4000** — **04** **04**

Heavy duty auto-drain

Basic size

Thread type

Nil	Rc
F	G
N	NPT

Port size

04	1/2 (Female thread)
----	---------------------

## Accessory (Option) \*

Nil	No option (Standard)
B	Bracket set
C	Ball valve piping set

## \* Notes

- 1) When more than one option is desired, list in alphabetical order.
- 2) Accessories are not factory assembled.
- 3) Refer to each drawing for details of dimensions and mounting methods.
- 4) Accessory "C" is available only with Rc thread.

HA

AT

ID

AMG

AFF

AM

Misc.

# Series ADH4000

## Construction

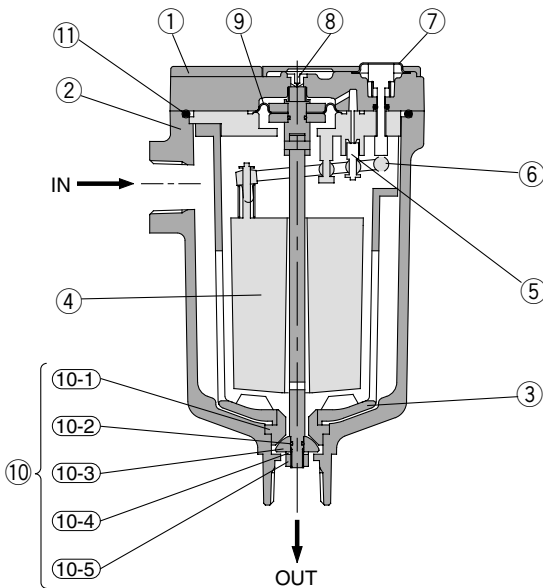

## Component Parts

No.	Description	Material	Note
①	Body	Aluminum alloy	Baking finish
②	Housing	Aluminum alloy	Baking finish
③	Drain guard	Aluminum alloy	Baking finish
④	Float	Foam rubber	
⑤	Pilot valve	Stainless steel + Rubber	
⑥	Lever	Resin	
⑦	Flushing button	Brass	
⑧	Orifice		
⑨	Diaphragm	Rubber	

## Replacement Parts

No.	Description	Part no.	Note
⑩	Repair kit for main valve	ADH-D400	Kit includes parts from 10-1 to 10-5.
⑪	O-ring	G85(B)	Material: NBR

Note) When changing parts, follow the instruction manual.  
Do not disassemble other parts.

## ⚠️ Precautions

Be sure to read before handling. Refer to pages 14-21-3 to 4 for Safety Instructions and Common Precautions on the products mentioned in this catalog, and pages 14-14-6 to 8 for Precautions on every series.

### Caution on Design

#### ⚠️ Caution

1. Operate this product in an area in which the air pressure does not exceed 1.6 MPa. If this value is exceeded, it could lead to an accident or malfunction.
2. An air pressure of 0.05 MPa and an air compressor's discharge flow rates higher than 50 l/min (ANR) are required. Below these values, the air will continue to be discharged from the drainage discharge port.
3. Keep the compressed air temperature and the ambient temperature of the location in which this product is installed within the range of 5 to 60°C. Exceeding this range could lead to failure or malfunction.
4. Avoid operating this product in an area in which corrosive gases, flammable gases or organic solvents are contained in the compressed air or in the surrounding air.

### Selection

#### ⚠️ Caution

1. The maximum dischargeable drainage rate is 400 cc/min. If the product is operated in excess of this value, there is a risk of causing the drainage to flow over to the outlet side.

### Piping

#### ⚠️ Caution

1. Use piping of 1/2B bore size or larger for drain inlet and allow for unobstructed flow-in for drain.
2. Drain line should be 8 mm or more in diameter and less than 10 m in length. Do not make any upward angles in drain line. Be sure to secure exhaust port piping since drain is under pressure.

### Mounting

#### ⚠️ Caution

1. Install with "out port" down in a vertical position. Inclination from the vertical line should be less than 5°.
2. Install with at least 200 mm of free space above the unit to allow for maintenance.
3. To place this product near the air compressor, install in such a way that the vibrations will not be transmitted.
4. Install a valve to drain inlet so that maintenance is possible. Use a ball valve with a bore size of more than 15 mm to ensure proper flow-in of drain. (Ball valve piping set is available as optional accessory.)
5. When not draining sufficiently, adjust the open angle of its bleed valve to lower the pressure inside the case, so that drainage will run through easily.

### Maintenance

#### ⚠️ Caution

1. Check drain condition periodically (more than once a day). Then push flushing button to open exhaust valve.
2. Pilot air is exhausted from the exhaust port indicated in the "Dimensions" section. Do not cover this exhaust port. Clean exhaust port so that port is not blocked by dust, etc.
3. When solid foreign objects exceeding 1 mm comes in, the main valve may become blocked. After recovering the internal pressure of this product to 0 MPa (atmospheric pressure), remove the hexagon socket head bolt (M6) from the body part and wash inside with water to remove foreign solid particles blocking the main valve.
4. While operating, there may be cases where drainage will not easily enter this product. In such a case, adjust the open angle of its bleed valve to lower the pressure a bit inside the bowl, so that drainage will run through easily.

# Heavy Duty Auto drain Series ADH4000

## Dimensions

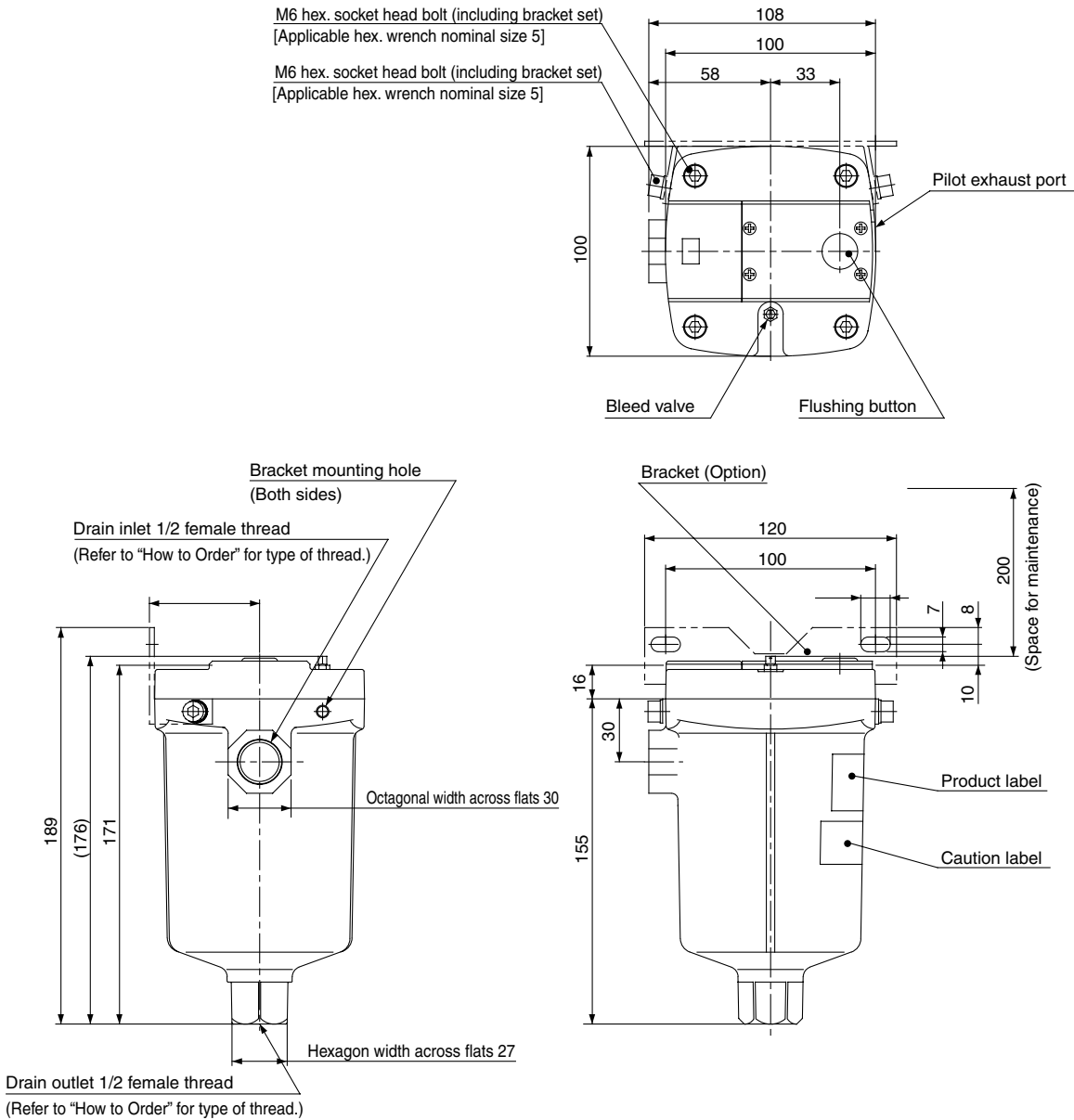

### Option: Reference Figure of Assembly

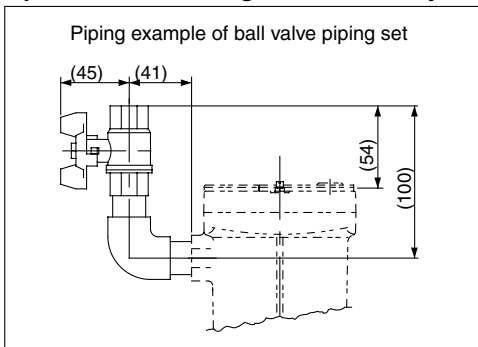

HA

AT

ID

AMG

AFF

AM

Misc.



# Safety Instructions

These safety instructions are intended to prevent a hazardous situation and/or equipment damage. These instructions indicate the level of potential hazard by labels of "Caution", "Warning" or "Danger". To ensure safety, be sure to observe ISO 4414 <sup>Note 1)</sup>, JIS B 8370 <sup>Note 2)</sup> and other safety practices.

 **Caution** : Operator error could result in injury or equipment damage.

 **Warning** : Operator error could result in serious injury or loss of life.

 **Danger** : In extreme conditions, there is a possible result of serious injury or loss of life.

Note 1) ISO 4414: Pneumatic fluid power--General rules relating to systems.

Note 2) JIS B 8370: General Rules for Pneumatic Equipment

## Warning

### **1. The compatibility of pneumatic equipment is the responsibility of the person who designs the pneumatic system or decides its specifications.**

Since the products specified here are used in various operating conditions, their compatibility for the specific pneumatic system must be based on specifications or after analysis and/or tests to meet your specific requirements. The expected performance and safety assurance will be the responsibility of the person who has determined the compatibility of the system. This person should continuously review the suitability of all items specified, referring to the latest catalog information with a view to giving due consideration to any possibility of equipment failure when configuring a system.

### **2. Only trained personnel should operate pneumatically operated machinery and equipment.**

Compressed air can be dangerous if an operator is unfamiliar with it. Assembly, handling or repair of pneumatic systems should be performed by trained and experienced operators.

### **3. Do not service machinery/equipment or attempt to remove components until safety is confirmed.**

1. Inspection and maintenance of machinery/equipment should only be performed once measures to prevent falling or runaway of the driver objects have been confirmed.
2. When equipment is to be removed, confirm the safety process as mentioned above. Cut the supply pressure for this equipment and exhaust all residual compressed air in the system.
3. Before machinery/equipment is restarted, take measures to prevent shooting-out of cylinder piston rod, etc.

### **4. Contact SMC if the product is to be used in any of the following conditions:**

1. Conditions and environments beyond the given specifications, or if product is used outdoors.
2. Installation on equipment in conjunction with atomic energy, railway, air navigation, vehicles, medical equipment, food and beverages, recreation equipment, emergency stop circuits, clutch and brake circuits in press applications, or safety equipment.
3. An application which has the possibility of having negative effects on people, property, or animals, requiring special safety analysis.



# Common Precautions

Be sure to read before handling.

For detailed precautions on every series, refer to main text.

## Selection

### Warning

#### 1. Confirm the specifications.

Products represented in this catalog are designed for use in compressed air applications only (including vacuum), unless otherwise indicated.

Do not use the product outside their design parameters.

Please contact SMC when using the products in applications other than compressed air (including vacuum).

## Mounting

### Warning

#### 1. Instruction manual

Install the products and operate them only after reading the instruction manual carefully and understanding its contents. Also keep the manual where it can be referred to as necessary.

#### 2. Securing the space for maintenance

When installing the products, please allow access for maintenance.

#### 3. Tightening torque

When installing the products, please follow the listed torque specifications.

## Piping

### Caution

#### 1. Before piping

Make sure that all debris, cutting oil, dust, etc., are removed from the piping.

#### 2. Wrapping of pipe tape

When screwing piping or fittings into ports, ensure that chips from the pipe threads or sealing material do not get inside the piping. Also, when the pipe tape is used, leave 1.5 to 2 thread ridges exposed at the end of the threads.

## Air Supply

### Warning

#### 1. Operating fluid

Please consult with SMC when using the product in applications other than compressed air (including vacuum).

Regarding products for general fluid, please ask SMC about applicable fluids.

#### 2. Install an air dryer, aftercooler, etc.

Excessive condensate in a compressed air system may cause valves and other pneumatic equipment to malfunction.

Installation of an air dryer, after cooler etc. is recommended.

#### 3. Drain flushing

If condensate in the drain bowl is not emptied on a regular basis, the bowl will over flow and allow the condensate to enter the compressed air lines.

If the drain bowl is difficult to check and remove, it is recommended that a drain bowl with the auto-drain option be installed.

For compressed air quality, refer to "Air Preparation Equipment" catalog.

#### 4. Use clean air

If the compressed air supply is contaminated with chemicals, synthetic materials, corrosive gas, etc., it may lead to break down or malfunction.

## Operating Environment

### Warning

1. Do not use in environments where the product is directly exposed to corrosive gases, chemicals, salt water, water or steam.

2. Do not expose the product to direct sunlight for an extended period of time.

3. Do not use in a place subject to heavy vibrations and/or shocks.

4. Do not mount the product in locations where it is exposed to radiant heat.

## Maintenance

### Warning

1. Maintenance procedures are outlined in the operation manual.

Not following proper procedures could cause the product to malfunction and could lead to damage to the equipment or machine.

#### 2. Maintenance work

If handled improperly, compressed air can be dangerous.

Assembly, handling and repair of pneumatic systems should be performed by qualified personnel only.

#### 3. Drain flushing

Remove drainage from air filters regularly. (Refer to the specifications.)

#### 4. Shut-down before maintenance

Before attempting any kind of maintenance make sure the supply pressure is shut of and all residual air pressure is released from the system to be worked on.

#### 5. Start-up after maintenance and inspection

Apply operating pressure and power to the equipment and check for proper operation and possible air leaks. If operation is abnormal, please verify product set-up parameters.

#### 6. Do not make any modifications to be product.

Do not take the product apart.

# Quality Assurance Information (ISO 9001, ISO 14001)

## Reliable quality of products in the global market

To enable our customers throughout the world to use our products with even greater confidence, SMC has obtained certification for international standards “ISO 9001” and “ISO 14001”, and created a complete structure for quality assurance and environmental controls. SMC products pursue to meet its customers’ expectations while also considering company’s contribution in society.

### Quality management system ISO 9001

This is an international standard for quality control and quality assurance. SMC has obtained a large number of certifications in Japan and overseas, providing assurance to our customers throughout the world.



### Environmental management system ISO 14001

This is an international standard related to environmental management systems and environmental inspections. While promoting environmentally friendly automation technology, SMC is also making diligent efforts to preserve the environment.



## SMC’s quality control system



### Quality policies

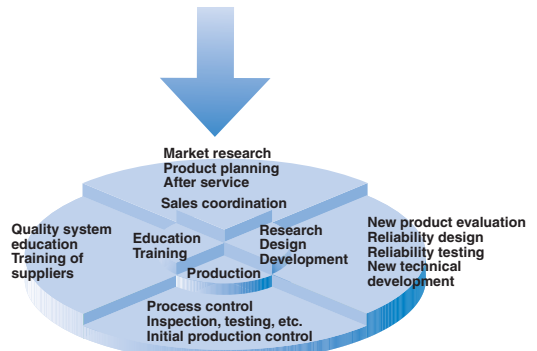

### Quality control activities

# SMC Product Conforming to Inter

SMC products complying with EN/ISO, CSA/UL standards are supporting



The CE mark indicates that machines and components meet essential requirements of all the EC Directives applied.

It has been obligatory to apply CE marks indicating conformity with EC Directives when machines and components are exported to the member Nations of the EU.

Once “A manufacturer himself” declares a product to be safe by means of CE marking (declaration of conformity by manufacturer), free distribution inside the member Nations of the EU is permissible.

## ■ CE Mark

SMC provides CE marking to products to which EMC and Low Voltage Directives have been applied, in accordance with CETOP (European hydraulics and pneumatics committee) guide lines.

## ■ As of February 1998, the following 18 countries will be obliged to conform to CE mark legislation

Iceland, Ireland, United Kingdom, Italy, Austria, Netherlands, Greece, Liechtenstein, Sweden, Spain, Denmark, Germany, Norway, Finland, France, Belgium, Portugal, Luxembourg

## ■ EC Directives and Pneumatic Components

### • Machinery Directive

The Machinery Directive contains essential health and safety requirements for machinery, as applied to industrial machines e.g. machine tools, injection molding machines and automatic machines. Pneumatic equipment is not specified in Machinery Directive. However, the use of SMC products that are certified as conforming to EN Standards, allows customers to simplify preparation work of the Technical Construction File required for a Declaration of Conformity.

### • Electromagnetic Compatibility (EMC) Directive

The EMC Directive specifies electromagnetic compatibility. Equipment which may generate electromagnetic interference or whose function may be compromised by electromagnetic interference is required to be immune to electromagnetic affects (EMS/immunity) without emitting excessive electromagnetic affects (EMI/emission).

### • Low Voltage Directive

This directive is applied to products, which operate above 50 VAC to 1000 VAC and 75 VDC to 1500 VDC operating voltage, and require electrical safety measures to be introduced.

### • Simple Pressure Vessels Directive

This directive is applied to welded vessels whose maximum operating pressure (PS) and volume of vessel (V) exceed 50 bar/L. Such vessels require EC type examination and then CE marking.



# national Standards

you to comply with EC directives and CSA/UL standards.



## ■ CSA Standards & UL Standards

UL and CSA standards have been applied in North America (U.S.A. and Canada) symbolizing safety of electric products, and are defined to mainly prevent danger from electric shock or fire, resulting from trouble with electric products. Both UL and CSA standards are acknowledged in North America as the first class certifying body. They have a long experience and ability for issuing product safety certificate. Products approved by CSA or UL standards are accepted in most states and governments beyond question.

Since CSA is a test certifying body as the National Recognized Testing Laboratory (NRTL) within the jurisdiction of Occupational Safety and Health Administration (OSHA), SMC was tested for compliance with CSA Standards and UL Standards at the same time and was approved for compliance with the two Standards. The above CSA NRTL/C logo is described on a product label in order to indicate that the product is approved by CSA and UL Standards.

## ■ TSSA (MCCR) Registration Products

TSSA is the regulation in Ontario State, Canada. The products that the operating pressure is more than 5 psi (0.03 MPa) and the piping size is bigger than 1 inch. fall into the scope of TSSA regulation.

## Products conforming to CE Standard



With CE symbol for simple visual recognition

In this catalog each accredited product series is indicated with a CE mark symbol. However, in some cases, every available models may not meet CE compliance. Please visit our web site for the latest selection of available models with CE mark.

<http://www.smcworld.com>



# SMC's Global Service Network

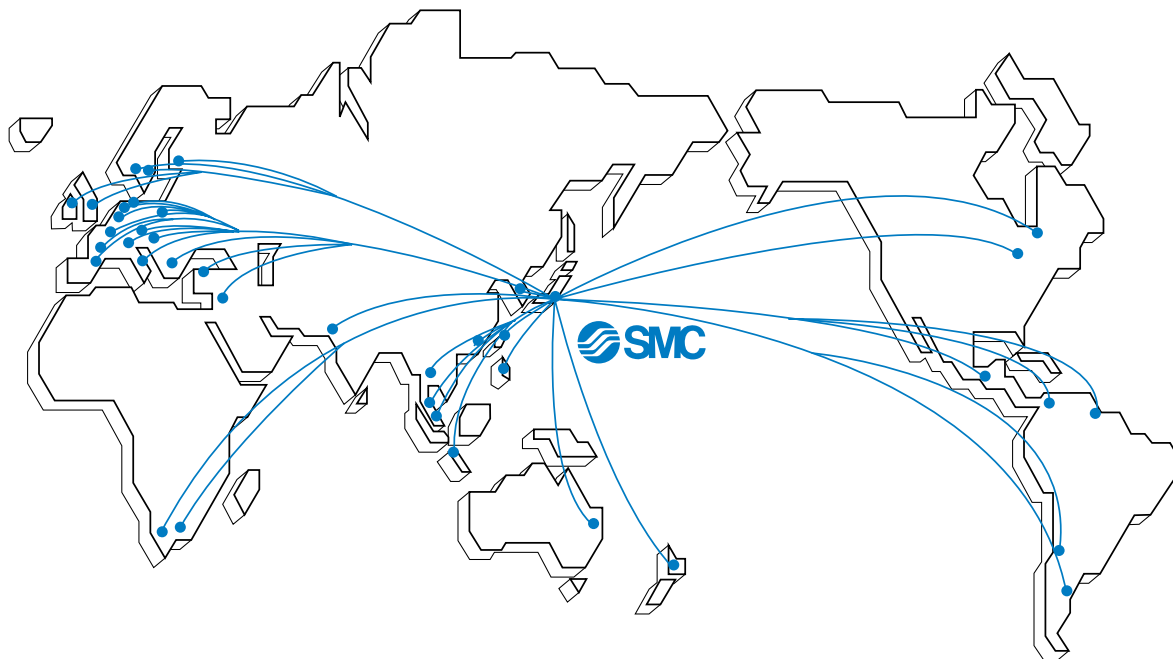

## America

### U.S.A. **SMC Corporation of America**

3011 North Franklin Road Indianapolis, IN 46226, U.S.A.  
TEL: 317-899-4440 FAX: 317-899-3102

### CANADA **SMC Pneumatics (Canada) Ltd.**

6768 Financial Drive Mississauga, Ontario, L5N 7J6 Canada  
TEL: 905-812-0400 FAX: 905-812-8686

### MEXICO **SMC Corporation (Mexico), S.A. DE C.V.**

Carr. Silao-Trejo K.M. 2.5 S/N, Predio San Jose del Duranzo  
C.P. 36100, Silao, Gto., Mexico  
TEL: 472-72-2-55-00 FAX: 472-72-2-59-44/2-59-46

### CHILE **SMC Pneumatics (Chile) S.A.**

Av. La Montaña 1,115 km. 16.5 P. Norte Parque  
Industrial Valle Grande, Lampa Santiago, Chile  
TEL: 02-270-8600 FAX: 02-270-8601

### ARGENTINA **SMC Argentina S.A.**

Teodoro Garcia 3860 (1427) Buenos Aires, Argentina  
TEL: 011-4555-5762 FAX: 011-4555-5762

### BOLIVIA **SMC Pneumatics Bolivia S.R.L.**

Avenida Beni Numero 4665  
Santa Cruz de la Sierra-Casilla de Correo 2281, Bolivia  
TEL: 591-3-3428383 FAX: 591-3-3449900

### VENEZUELA **SMC Neumatica Venezuela S.A.**

Apartado 40152, Avenida Nueva Granada, Edificio Wanlac,  
Local 5, Caracas 1040-A, Venezuela  
TEL: 2-632-1310 FAX: 2-632-3871

### PERU (Distributor) **IMPECO Automatizacion Industrial S.A.**

AV. Canevaro 752, Lince, Lima, Peru  
TEL: 1-471-6002 FAX: 1-471-0935

### URUGUAY (Distributor) **BAKO S.A.**

Galicia 1650 esq. Gaboto C.P. 11200, Montevideo, Uruguay  
TEL: 2-401-6603 FAX: 2-409-4306

### BRAZIL **SMC Pneumaticos Do Brasil Ltda.**

Rua. Dra. Maria Fidelis, nr. 130, Jardim Piraporinha-Diadema-S.P.  
CEP: 09950-350, Brasil  
TEL: 11-4051-1177 FAX: 11-4071-6636

### COLOMBIA (Distributor) **Airmatic Ltda.**

Calle 18 69-05 Apart. Aereo 081045 Santa Fe de Bogotá, Colombia  
TEL: 1-424-9240 FAX: 1-424-9260

## Europe

### U.K. **SMC Pneumatics (U.K.) Ltd.**

Vincent Avenue, Crownhill, Milton Keynes, MK8 0AN, Buckinghamshire, U.K.  
TEL: 01908-563888 FAX: 01908-561185

### GERMANY **SMC Pneumatik GmbH**

Boschring 13-15 D-63329 Egelsbach, Germany  
TEL: 06103-4020 FAX: 06103-402139

### ITALY **SMC Italia S.p.A.**

Via Garibaldi 62 I-20061 Carugate Milano, Italy  
TEL: 02-9271365 FAX: 02-9271365

### FRANCE **SMC Pneumatique S.A.**

1 Boulevard de Strasbourg, Parc Gustave Eiffel, Bussy Saint Georges, F-77600  
Marne La Vallee Cedex 3 France  
TEL: 01-64-76-10-00 FAX: 01-64-76-10-10

### SWEDEN **SMC Pneumatics Sweden AB**

Ekhagsvägen 29-31, S-141 05 Huddinge, Sweden  
TEL: 08-603-07-00 FAX: 08-603-07-10

### SWITZERLAND **SMC Pneumatik AG**

Dorfstrasse 7, Postfach 117, CH-8484 Weisslingen, Switzerland  
TEL: 052-396-3131 FAX: 052-396-3191

### AUSTRIA **SMC Pneumatik GmbH (Austria)**

Girakstrasse 8, A-2100 Korneuburg, Austria  
TEL: 0-2262-6228-0 FAX: 0-2262-62285

### SPAIN **SMC España, S.A.**

Zuazobidea 14 Pol. Ind. Júndiz 01015 Vitoria, Spain  
TEL: 945-184-100 FAX: 945-184-510

### IRELAND **SMC Pneumatics (Ireland) Ltd.**

2002 Citywest Business Campus, Naas Road, Saggart, Co. Dublin, Ireland  
TEL: 01-403-9000 FAX: 01-466-0385

### NETHERLANDS (Associated company) **SMC Pneumatics BV**

De Ruyterkade 120, NL-1011 AB Amsterdam, Netherlands  
TEL: 020-5318888 FAX: 020-5318880

### GREECE (Distributor) **S.Parianopoulos S.A.**

7, Konstantinoupoleos Street 11855 Athens, Greece  
TEL: 01-3426076 FAX: 01-3455578

### DENMARK **SMC Pneumatik A/S**

Knudsminde 4 B DK-8300  
Odder, Denmark  
TEL: 70252900 FAX: 70252901

## Europe

**FINLAND SMC Pneumatics Finland OY**

PL72, Tiistiniityntie 4, SF-02231 ESP00, Finland  
TEL: 09-8595-80 FAX: 09-8595-8595

**NORWAY SMC Pneumatics Norway A/S**

Vollsvæien 13C, Granfoss Næringspark N-1366 LYSAKER, Norway  
TEL: 67-12-90-20 FAX: 67-12-90-21

**BELGIUM (Distributor) SMC Pneumatics N.V./S.A.**

Nijverheidsstraat 20 B-2160 Wommelgem Belgium  
TEL: 03-355-1464 FAX: 03-355-1466

**POLAND SMC Industrial Automation Polska Sp.z.o.o.**

ul. Konstruktorska 11A, PL-02-673 Warszawa, Poland  
TEL: 022-548-5085 FAX: 022-548-5087

**TURKEY (Distributor) Entek Pnömatik San.ve Tic. Ltd. Sti**

Perpa Tic. Merkezi Kat:11 No.1625 80270 Okmeydani Istanbul, Türkiye  
TEL: 0212-221-1512 FAX: 0212-221-1519

**RUSSIA SMC Pneumatik LLC.**

36/40 Sredny prospect V.O. St. Petersburg 199004, Russia  
TEL: 812-118-5445 FAX: 812-118-5449

**CZECH SMC Industrial Automation CZ s.r.o.**

Hudcova 78a, CZ-61200 Brno, Czech Republic  
TEL: 05-4121-8034 FAX: 05-4121-8034

**HUNGARY SMC Hungary Ipari Automatizálási kft.**

Budafoki ut 107-113 1117 Budapest  
TEL: 01-371-1343 FAX: 01-371-1344

**ROMANIA SMC Romania S.r.l.**

Str. Frunzei, Nr. 29, Sector 2, Bucharest, Romania  
TEL: 01-3205111 FAX: 01-3261489

**SLOVAKIA SMC Priemyselná automatizácia, s.r.o.**

Nova 3, SK-83103 Bratislava  
TEL: 02-4445-6725 FAX: 02-4445-6028

**SLOVENIA SMC Industrijska Avtomatila d.o.o.**

Grajski trg 15, SLO- 8360 Zuzemberk, Slovenia  
TEL: 07388-5240 FAX: 07388-5249

**LATVIA SMC Pneumatics Latvia SIA**

Šmerļa ielā 1-705, Rīga LV-1006  
TEL: 777 94 74 FAX: 777 94 75

**SOUTH AFRICA (Distributor) Hyflo Southern Africa (Pty.) Ltd.**

P.O.Box 240 Paardeneiland 7420 South Africa  
TEL: 021-511-7021 FAX: 021-511-4456

**EGYPT (Distributor) Saadani Trading & Ind. Services**

15 Sebaai Street, Miami 21411 Alexandria, Egypt  
TEL: 3-548-50-34 FAX: 3-548-50-34

## Oceania/Asia

**AUSTRALIA SMC Pneumatics (Australia) Pty.Ltd.**

14-18 Hudson Avenue Castle Hill NSW 2154, Australia  
TEL: 02-9354-8222 FAX: 02-9894-5719

**NEW ZEALAND SMC Pneumatics (New Zealand) Ltd.**

8C Sylvia Park Road Mt.Wellington Auckland, New Zealand  
TEL: 09-573-7007 FAX: 09-573-7002

**TAIWAN SMC Pneumatics (Taiwan) Co.,Ltd.**

17, Lane 205, Nansan Rd., Sec.2, Luzhu-Hsiang, Taoyuan-Hsien, TAIWAN  
TEL: 03-322-3443 FAX: 03-322-3387

**HONG KONG SMC Pneumatics (Hong Kong) Ltd.**

29/F, Clifford Centre, 778-784 Cheung, Sha Wan Road, Lai Chi Kok, Kowloon, Hong Kong  
TEL: 2744-0121 FAX: 2785-1314

**SINGAPORE SMC Pneumatics (S.E.A.) Pte. Ltd.**

89 Tuas Avenue 1, Jurong Singapore 639520  
TEL: 6861-0888 FAX: 6861-1889

**PHILIPPINES SHOKETSU SMC Corporation**

Unit 201 Common Goal Tower, Madrigal Business Park, Ayala Alabang Muntinlupa, Philippines  
TEL: 02-8090565 FAX: 02-8090586

**MALAYSIA SMC Pneumatics (S.E.A.) Sdn. Bhd.**

Lot 36 Jalan Delima1/1, Subang Hi-Tech Industrial Park, Batu 3 40000 Shah Alam Selangor, Malaysia  
TEL: 03-56350590 FAX: 03-56350602

**SOUTH KOREA SMC Pneumatics Korea Co., Ltd.**

Woolim e-BIZ Center (Room 1008), 170-5, Guro-Dong, Guro-Gu, Seoul, 152-050, South Korea  
TEL: 02-3219-0700 FAX: 02-3219-0702

**CHINA SMC (China) Co., Ltd.**

7 Wan Yuan St. Beijing Economic & Technological Development Zone 100176, China  
TEL: 010-67882111 FAX: 010-67881837

**THAILAND SMC Thailand Ltd.**

134/6 Moo 5, Tiwanon Road, Bangkok, Amphur Muang, Patumthani 12000, Thailand  
TEL: 02-963-7099 FAX: 02-501-2937

**INDIA SMC Pneumatics (India) Pvt. Ltd.**

D-107 to 112, Phase-2, Extension, Noida, Dist. Gautaim Budh Nagar, U.P. 201 305, India  
TEL: (0120)-4568730 FAX: 0120-4568933

**INDONESIA (Distributor) P.T. Riyadi Putera Makmur**

Jalan Hayam Wuruk Komplek Glodok Jaya No. 27-28 Jakarta 11180 Indonesia  
TEL: 021-625 5548 FAX: 021-625 5888

**PAKISTAN (Distributor) Jubilee Corporation**

First Floor Mercantile Centre, Newton Road Near Boulton Market P.O. Box 6165 Karachi 74000 Pakistan  
TEL: 021-243-9070/8449 FAX: 021-241-4589

**ISRAEL (Distributor) Baccara Automation Control**

Kvutza Geva 18915 Israel  
TEL: 04-653-5960 FAX: 04-653-1445

**SAUDI ARABIA (Distributor) Assaggaff Trading Est.**

P.O. Box 3385 Al-Amir Majed Street, Jeddah-21471, Saudi Arabia  
TEL: 02-6761574 FAX: 02-6708173