

Water-cooled Thermo-chiller *Series HRW*

Refrigerant-free and energy saving type using no compressor. Ideal for ordinary temperature and high temperature processes.

- Type of circulating fluid: Fluorinated fluids/Ethylene glycol aqueous solution/Clear water, Deionized water
- Temperature range setting: **68** to **194**°F (20 to 90°C)
- Cooling capacity: **2** kW/**8** kW/**15** kW/**30** kW
- Temperature stability: \pm **0.54**°F (\pm 0.3°C)

More effective energy-saving through use of an inverter pump



Inverter type
Power consumption
0.5 kWh/h
Facility water
0.32 gpm
(1.2 L/min)

HRG
HRH
HRZ
HRZD
HRW
HEC
HEB
HED
Technical Data
Related Products

● International standards:



SEMATECH
S2-93, S8-95

SEMI Standard
S2-0703, S8-1103, F47-0200

Energy-Saving and Refrigerant-free

Energy-saving and refrigerant-free (Ordinary temperature up to 194°F (90°C))

The water-cooled Thermo-chiller which does not use a compressor (refrigerant-free) is suitable for processes operating from ordinary temperature to 194°F (90°C). The energy-savings shown below can be achieved in comparison with existing models (depending on the conditions).

Power consumption: Max. 59% reduction (SMC comparison)

The power consumption can be reduced by direct heat exchange between the circulating fluid and facility water with no refrigerating circuit.

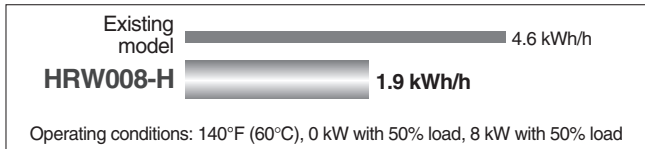

Operating conditions: 140°F (60°C), 0 kW with 50% load, 8 kW with 50% load

- Reduced running cost
- Contribution to the environmental preservation

Circulating fluid: Max. 13% reduction (SMC comparison)

Enhanced temperature control technology and the unique pump/tank construction achieved the reduced circulating fluid required for operation.

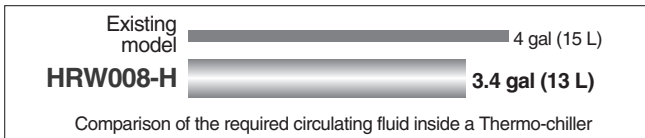

Comparison of the required circulating fluid inside a Thermo-chiller

- Reduced initial cost
- Contribution to the environmental preservation

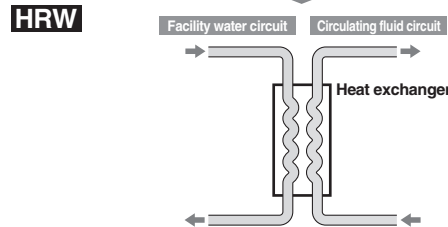
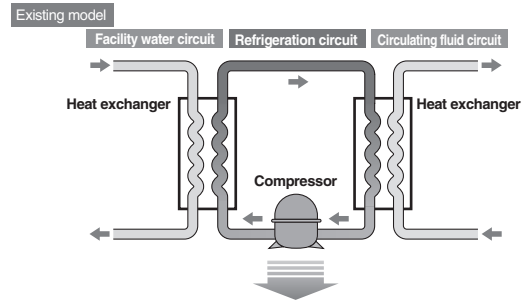

Facility water: Max. 89% reduction (SMC comparison)

The HRW series can achieve reduction in power consumption as it does not have a compressor, and reduction in the amount of facility water used because heat is exchanged directly with the circulating fluid.

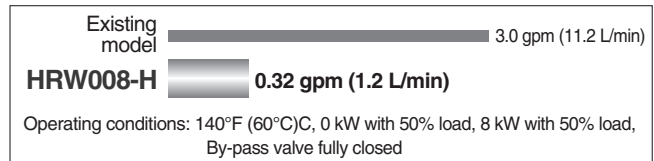

Operating conditions: 140°F (60°C), 0 kW with 50% load, 8 kW with 50% load, By-pass valve fully closed

- Reduced facilities investment
- Space saved facility water equipment
- Reduced running cost

Pump Inverter Type

More effective energy-saving is achieved through use of an *inverter pump*.

Power consumption: Max. 89% reduction (SMC comparison)

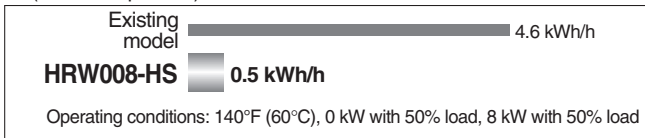

Operating conditions: 140°F (60°C), 0 kW with 50% load, 8 kW with 50% load

Facility water: Max. 89% reduction (SMC comparison)

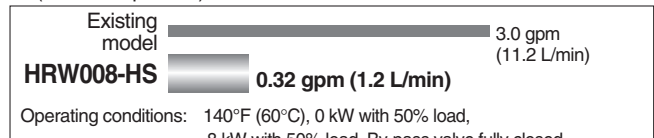

Operating conditions: 140°F (60°C), 0 kW with 50% load, 8 kW with 50% load, By-pass valve fully closed

Space-Saving

Installation area: Max. 45% reduction (SMC comparison)

(Forced exhaust from rear side)

By emitting the heat from the back, ventilation slits on the side are unnecessary offering reduced installation space.

Thermo-chiller with exhaust from the side:

Body space: W15.7in (400 mm) x D 33.3 in (845 mm)
Ventilation space: 3.9 in (100 mm)

HRW008-H : Body space: W15.0 in (380 mm) x D 26.2 in (665 mm)
Ventilation space: 0

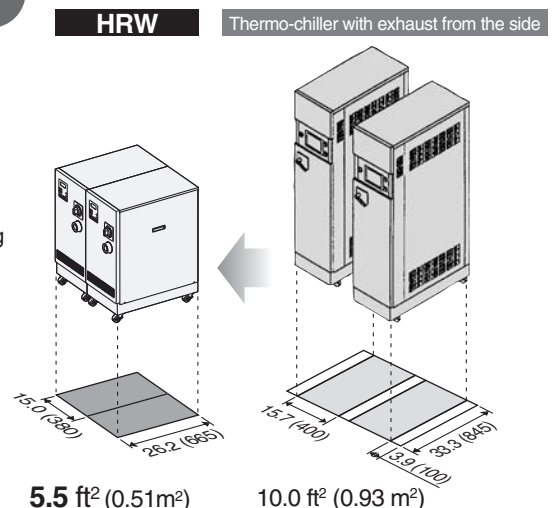

High Performance

- **Temperature stability: $\pm 0.54^{\circ}\text{F}$**
(when a load is stable)
Enhanced temperature control technology achieved $\pm 0.54^{\circ}\text{F}$ ($\pm 0.3^{\circ}\text{C}$) temperature stabilities when a load is stable.

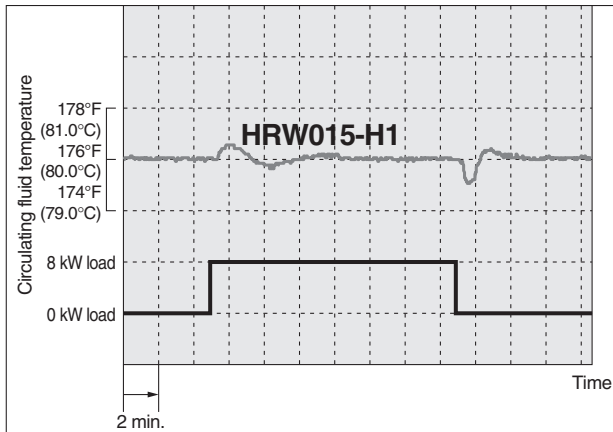

- **Cooling capacity: Max. 30 kW**
Up to 30 kW cooling capacity achieved.

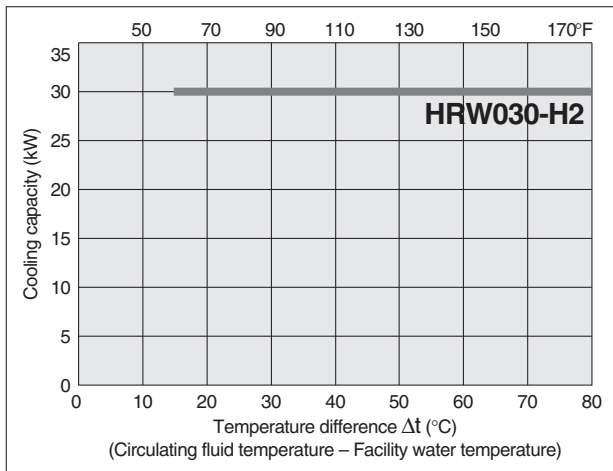

Easy maintenance

- Checking the electrical component parts accessible from the front side only

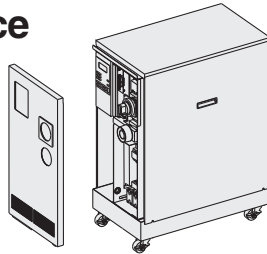

- Possible to replace the maintenance parts (such as a pump) without removing the pipings and discharging the circulating fluid.

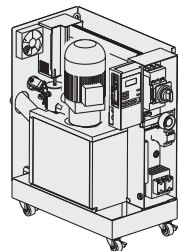

- Various alarm displays (Refer to page 117.)

Easy Maintenance

- **Circulating fluid automatic recovery function** (Refer to "Options" on page 119.)
Circulating fluid inside a Thermo-chiller tank can be recovered automatically. (Recovery volume: 3.2 gal (12 L))

- Reduced maintenance time
- Faster operation
- Reduced circulating liquid loss by evaporation or spill

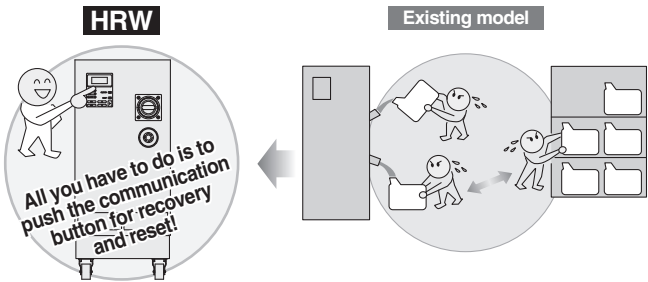

1. Normal operation

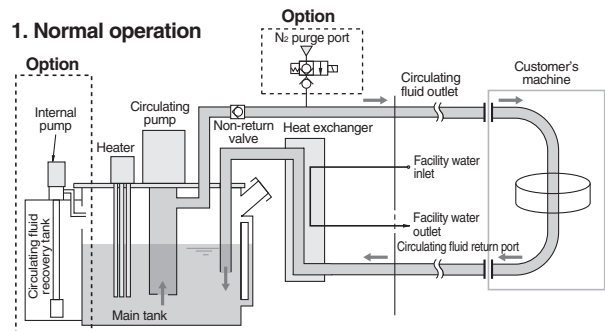

2. Circulating fluid recovery

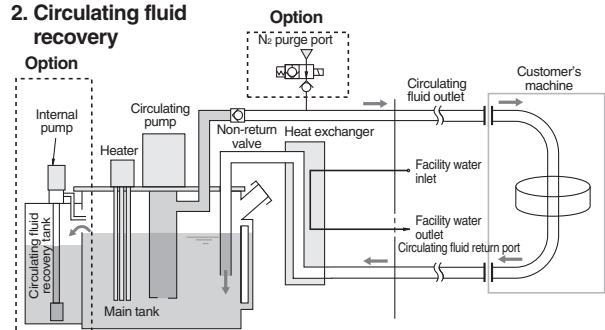

3. Fluid returns to the main tank from the circulating fluid recovery tank.

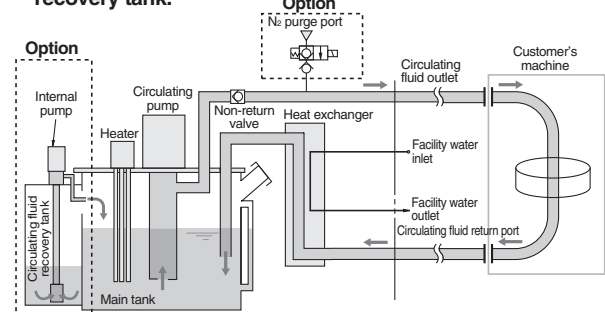

- **Circulating fluid electrical resistivity control function**
(Refer to "Options" on page 118.)
(DI control kit)

HRG

HRS

HRZ

HRZD

HRW

HEC

HEB

HED

Technical Data

Related Products

Electrical Resistivity Control

DI control kit

(Refer to "Options" on page 118.)

Electrical resistivity of circulating fluid (ethylene glycol aqueous solution and deionized water) can be controlled.

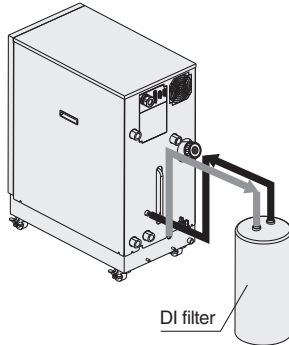

Communications

- Contact input/output signal
- Serial RS-485 communication
- Analog communication (Refer to "Options" on page 118.)
- DeviceNet communication (Refer to "Options" on page 118.)

DeviceNet™

Wetted parts adopt the materials compatible for various circulating fluids.

(Stainless steel, EPDM, etc.)

- Fluorinated fluids: Flourinert™ FC-40
GALDEN® HT200
- 60% ethylene glycol aqueous solution
- Deionized water/Clear water

Regarding the fluid other than the above, please contact SMC. Flourinert™ is a trademark of 3M. GALDEN® is a registered trademark of Solvay Solexis, Inc.

Construction and Principles

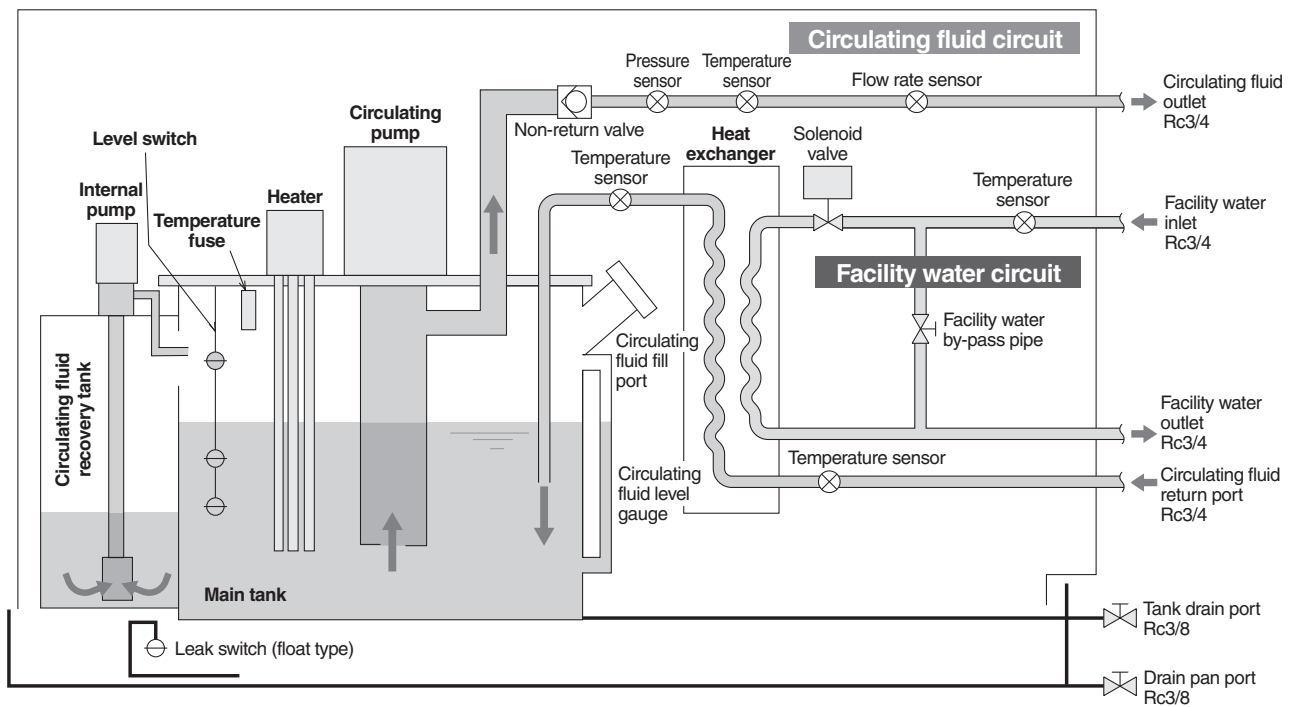

Circulating fluid circuit

With the **circulating pump**, circulating fluid will be discharged to the customer's machine side. After the circulating fluid will heat or cool the customer's machine side, it will be returned to the **main tank** via the **heat exchanger**.

When the automatic circulating fluid recovery function, which recovers the circulating fluid from the customer's machine, is selected (refer to page 99), a **sub-tank** for recovery is installed. The **internal pump** is used to transfer a circulating fluid from the **sub-tank** to the **main tank**.

Facility water circuit

When the circulating fluid temperature rises higher than the set temperature, open the **solenoid valve** to introduce facility water to the **heat exchanger**.

When the circulating fluid temperature falls back below the set temperature, close the **solenoid valve** to shut off facility water to the **heat exchanger**.

Application Examples

Semiconductor

Example: Temperature control of chamber electrode

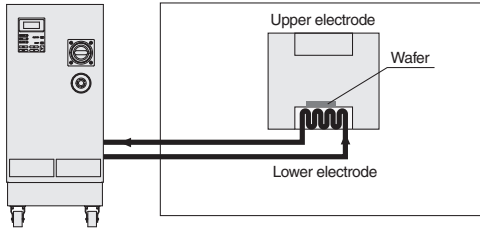

- Etching equipment
- Spatter equipment
- Cleaning equipment
- Coating equipment
- Dicing equipment
- Tester, etc.

Medical

Example: Blood preservation

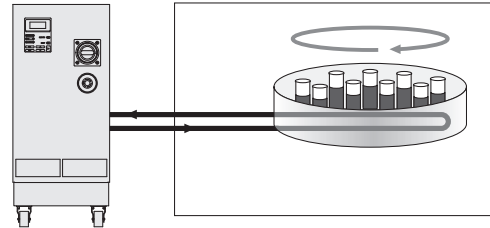

- X-ray instrument
- MRI
- Blood preservation equipment

Food

Example: Tofu (Bean curd) production

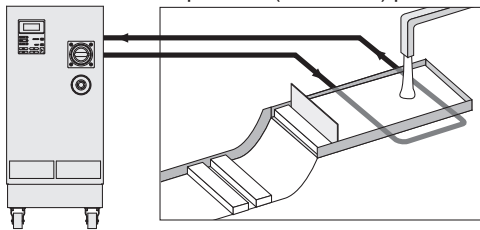

- Bottle-cleaning machine
 - Tofu (Bean curd) production equipment
 - Noodle-making machine, etc.
- Water temperature control for forming tofu by mixing the boiled soybean milk and bitter

Analysis

Example: Electronic microscope

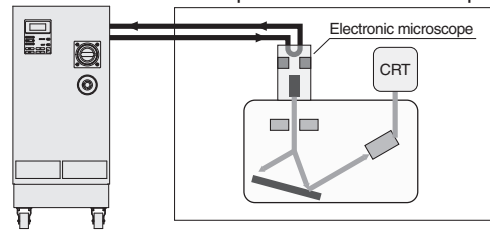

- Electron microscope
 - X-ray analytical instrument
 - Gas chromatography
 - Sugar level analytical instrument, etc.
- Prevents the distortion caused by the heat generated by the electronic gun in an electronic microscope.

Machine tool

Example: Laser machining

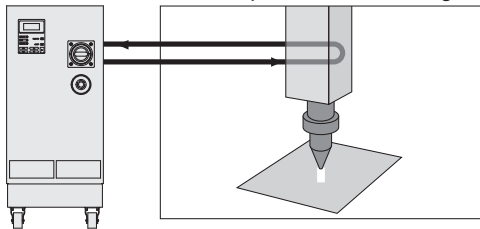

- Wire cutting
 - Grinder
 - Spot welding
 - Plasma welding
 - Laser machining, etc.
- Temperature-controlling the laser generating tube enables the laser wave length to be optimised, improving the accuracy of the machined cross sectional area.

Printing

Example: Printing temperature control

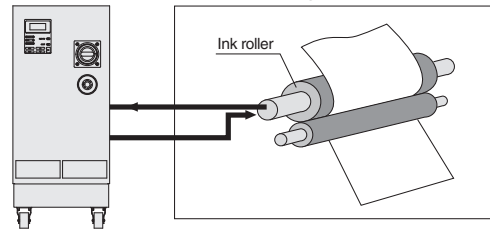

- Offset printing machine
 - Automatic developing machine
 - UV equipment, etc.
- Temperature-controlling the ink roller enables to control the evaporation amount and viscosity of an ink and optimise the tint of colors.

Molding

Example: Injection molding

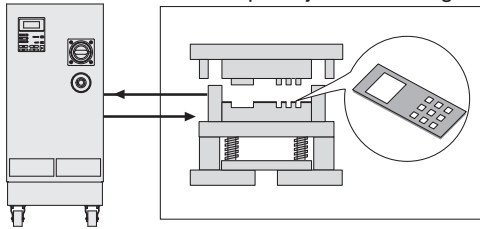

- Plastic molding
 - Rubber molding
 - Wire cable coating machine
 - Injection molding, etc.
- Temperature-controlling the mold results in improved product quality.

HRG
HRS
HRZ
HRZD
HRW
HEC
HEB
HED
Technical Data
Related Products

CONTENTS

Series HRW

Model Selection	
• Guide to Model Selection	Page 104
• Required Cooling Capacity Calculation.....	Page 105, 106
• Precautions on Model Selection	Page 106
• Circulating Fluid Typical Physical Property Values	Page 107
● Fluorinated Fluid Type	
How to Order/Specifications	Page 108
Cooling Capacity/Heating Capacity/ Pump Capacity	Page 109
● Ethylene Glycol Type	
How to Order/Specifications	Page 110
Cooling Capacity/Heating Capacity/ Pumping Capacity	Page 111
● Clear/Deionized Water Type	
How to Order/Specifications	Page 112
Cooling Capacity/Heating Capacity/ Pumping Capacity	Page 113
● Common Specifications	
Dimensions	Page 114
Communication Function	Page 115
• Contact Input/Output	Page 115
• Serial RS-485	Page 116
• Connector Location	Page 116
Operation Panel Display	Page 117
Alarm	Page 117
● Options	
• Analog Communication	Page 118
• DeviceNet Communication	Page 118
• NPT Fitting	Page 118
• DI Control Kit	Page 118
• Circulating Fluid Automatic Recovery.....	Page 119
● Optional Accessories	
• By-pass Piping Set.....	Page 120
• Anti-quake Bracket	Page 120
• 4-Port Manifold	Page 121
• DI Filter	Page 121
• Insulating Material for DI Filter	Page 121
• Contaminant Filter	Page 122
• 60% Ethylene Glycol Aqueous Solution	Page 122
• Concentration Meter	Page 122
Specific Product Precautions	Page 123 to 125

HRG

HRS

HRZ

HRZD

HRW

HEC

HEB

HED

Technical
Data

Related
Products

Series HRW Model Selection

Guide to Model Selection

1. How much is the temperature in degrees centigrade for the circulating fluid?

Temperature range which can be set with the Thermo-chiller

H: 68 to 195°F (20°C to 90°C)

Example) Customer requirement: 122°F (50°C)

2. What kind of the circulating fluids will be used?

Relationship between circulating fluid (which can be used with the Thermo-chiller) and temperature

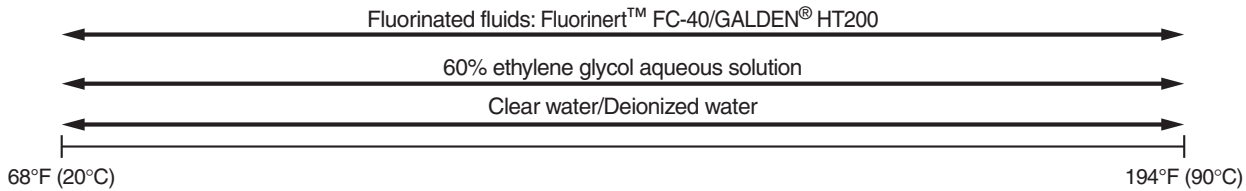

Example) Customer requirement: Clear water

3. How much is the temperature in degrees centigrade for the facility water?

Temperature range which can be set with the Thermo-chiller

10°C to 35°C

Example) Facility water temperature of customer's machine: 15°C

Temperature difference between the circulating fluid and facility water is: $50 - 15 = 95^\circ\text{F}$ (35°C).

4. What is the kW for the required cooling capacity?

Example) Customer requirement: 20 kW

Plot the point where the temperature difference between the circulating fluid and facility water (95°F (35°C)) intersects the cooling capacity (20 kW) in the cooling capacity graph.

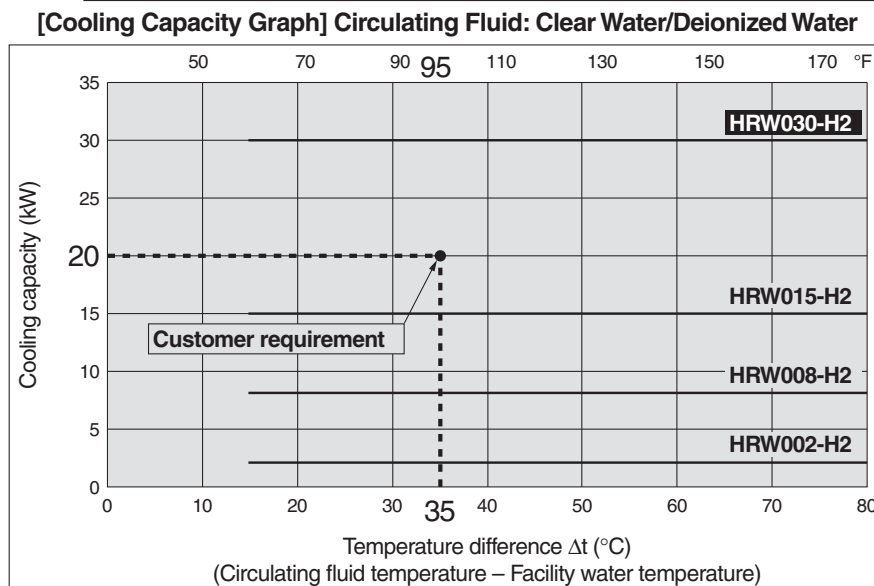

The point plotted in the graph is the requirement from your customer. Select the Thermo-chiller models exceeding this point. In this case, select the **HRW030-H2**.

Required Cooling Capacity Calculation

Example 1: When the heat generation amount in the customer's machine is known.

Heat generation amount **Q**: 3.5 kW

Cooling capacity = Considering a safety factor of 20%, $3.5 \times 1.2 = 4.2 \text{ kW}$

Example 2: When the heat generation amount in the customer's machine is not known.

Obtain the temperature difference between inlet and outlet by circulating the circulating fluid inside the customer's machine.

Heat generation amount **Q** : Unknown
 Circulating fluid temperature difference $\Delta T (= T2 - T1)$: 6.0°C (6.0 K)
 Circulating fluid outlet temperature **T1** : 20°C (293.15 K)
 Circulating fluid return temperature **T2** : 26°C (299.15 K)
 Circulating fluid flow rate **L** : 20 L/min
 Circulating fluid : Fluorinated fluid
 Density γ : $1.80 \times 10^3 \text{ kg/m}^3$
 Specific heat **C**:
 $0.96 \times 10^3 \text{ J/(kg}\cdot\text{K)}$
 (at 20°C)

* Refer to page 107 for the typical physical property values by circulating fluid.

$$Q = \frac{\Delta T \times L \times \gamma \times C}{60 \times 1000}$$

$$= \frac{6.0 \times 20 \times 1.80 \times 10^3 \times 0.96 \times 10^3}{60 \times 1000}$$

$$= 3456 \text{ W} = 3.5 \text{ kW}$$

Cooling capacity = Considering a safety factor of 20%,
 $3.5 \times 1.2 = 4.2 \text{ kW}$

Example of conventional measurement units (Reference)

Unknown
 6.0°C
 20°C
 26°C
 1.2 m³/h
 Fluorinated fluid
 Density γ : $1.80 \times 10^3 \text{ kg/m}^3$
 Specific heat **C**: 0.23 kcal/kg·°C
 (at 20°C)

* Refer to page 107 for the typical physical property values by circulating fluid.

$$Q = \frac{\Delta T \times L \times \gamma \times C}{860}$$

$$= \frac{6.0 \times 1.2 \times 1.80 \times 10^3 \times 0.23}{860}$$

$$= 3.5 \text{ kW}$$

Cooling capacity = Considering a safety factor of 20%,
 $3.5 \times 1.2 = 4.2 \text{ kW}$

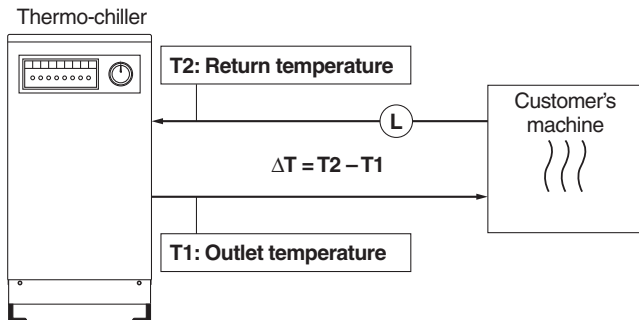

HRG

HRS

HRZ

HRZD

HRW

HEC

HEB

HED

Technical Data

Related Products

Required Cooling Capacity Calculation

Example 3. When there is no heat generation, and when cooling the object below a certain temperature and period of time.

Cooled substance total volume V : 60 L
 Cooling time h : 15 min
 Cooling temperature difference ΔT : 20°C (20 K) (70°C – 50°C → 20°C)
 Facility water temperature : 20°C (293.15 K)
 Circulating fluid : Fluorinated fluid
 Density γ : 1.74 x 10³ kg/m³
 Specific heat C : 1.05 x 10³ J/(kg·K)
 (at 50°C)

* Refer to page 107 for the typical physical property values by circulating fluid.

$$Q = \frac{\Delta T \times V \times \gamma \times C}{h \times 60 \times 1000}$$

$$\frac{20 \times 60 \times 1.74 \times 10^3 \times 1.05 \times 10^3}{15 \times 60 \times 1000} = 2436 \text{ W} = 2.4 \text{ kW}$$

Cooling capacity = Considering a safety factor of 20%,

$$2.4 \times 1.2 = 2.9 \text{ kW (When the circulating fluid temperature is 50°C.)}$$

(In this case, selected Thermo-chiller model will be the HRW008-H.)

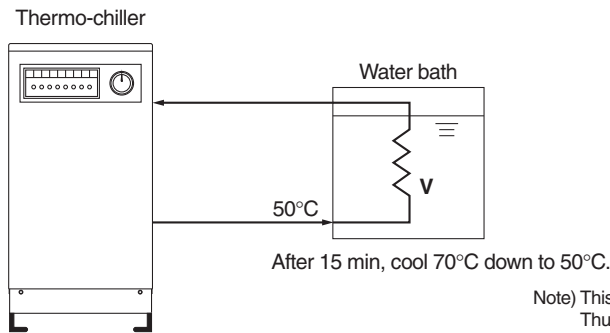

Note) This is the calculated value by changing the fluid temperature only.
 Thus, it varies substantially depending on the water bath or piping material or shape.

Example of conventional measurement units (Reference)

0.06 m³
 0.25 h
 20°C
 20°C
 Fluorinated fluid
 Density γ : 1.74 x 10³ kg/m³
 Specific heat C : 0.25 kcal/kg·°C
 (at 50°C)

* Refer to page 107 for the typical physical property values by circulating fluid.

$$Q = \frac{\Delta T \times V \times \gamma \times C}{h \times 860}$$

$$= \frac{20 \times 0.06 \times 1.74 \times 10^3 \times 0.25}{0.25 \times 860}$$

$$= 2.4 \text{ kW}$$

Cooling capacity = Considering a safety factor of 20%,

$$2.4 \times 1.2 = 2.9 \text{ kW (When the circulating fluid temperature is 50°C.)}$$

(In this case, selected Thermo-chiller model will be the HRW008-H.)

Precautions on Model Selection

1. Temperature difference between the circulating fluid and facility water

The HRW series exchanges heat between the circulating fluid and facility water directly, so it may not be possible to lower the circulating fluid temperature to the set temperature if the facility water temperature is too high. Check that the facility water temperature can be maintained for the circulating fluid temperature referring to the cooling capacity graph of each model before using.

2. Heating capacity

When setting the circulating fluid temperature at a higher temperature than the room temperature, the circulating fluid temperature will be heated with the Thermo-chiller. Heating capacity varies depending on the circulating fluid temperature. Also, the heating capacity varies depending on the circulating fluid temperature. Consider the heat radiation amount or thermal capacity of the customer's equipment. Check beforehand if the required heating capacity is provided, based on the heating capacity graph for the respective model.

3. Pump capacity

<Circulating fluid flow rate>

Pump capacity varies depending on the model selected from the HRW series. Also, circulating fluid flow varies depending on the circulating fluid discharge pressure. Consider the installation height difference between our Thermo-chiller and a customer's machine, and the piping resistance such as circulating fluid pipings, or piping size, or piping curves in the machine. Check beforehand if the required flow rate is achieved, using the pump capacity curves for each respective model.

<Circulating fluid discharge pressure>

Circulating fluid discharge pressure has the possibility to increase up to the maximum pressure in the pump capacity curves for the respective model. Check beforehand if the circulating fluid pipings or circulating fluid circuit of the customer's machine are fully durable against this pressure.

Circulating Fluid Typical Physical Property Values

* The below shown are reference values.
Please contact circulating fluid supplier for details.

Fluorinated Fluids

Physical property value Temperature	Density γ	Specific heat C	
	[kg/m ³] [g/L]	[J/(kg·K)]	[[kcal/kg·°C]]
-10°C	1.87 x 10 ³	0.87 x 10 ³	0.21
20°C	1.80 x 10 ³	0.96 x 10 ³	0.23
50°C	1.74 x 10 ³	1.05 x 10 ³	0.25
80°C	1.67 x 10 ³	1.14 x 10 ³	0.27

60% Ethylene Glycol Aqueous Solution

Physical property value Temperature	Density γ	Specific heat C	
	[kg/m ³] [g/L]	[J/(kg·K)]	[[kcal/kg·°C]]
-10°C	1.10 x 10 ³	3.02 x 10 ³	0.72
20°C	1.08 x 10 ³	3.15 x 10 ³	0.75
50°C	1.06 x 10 ³	3.27 x 10 ³	0.78
80°C	1.04 x 10 ³	3.40 x 10 ³	0.81

Water

Density γ : 1 x 10³ [kg/m³] [g/L]

Specific heat C: 4.2 x 10³ [J/(kg·K)] (1.0 [kcal/kg·°C])

HRG

HRH

HRZ

HRZD

HRW

HEC

HEB

HED

Technical Data

Related Products

Thermo-chiller **Fluorinated Fluid Type**

Series **HRW**



SEMI

How to Order

Fluorinated Fluid Type

HRW **002** - H **□** - **□**

Cooling capacity

Symbol	Cooling capacity
002	2 kW
008	8 kW
015	15 kW
030	30 kW

Temperature range setting

Symbol	Temperature range setting
H	68 to 194°F (20 to 90°C)

Option

Symbol	Option
Nil	None
C	Analog communication
D	DeviceNet communication
N	NPT fitting
Z	Circulating fluid automatic recovery

Pump inverter control

Symbol	Pump inverter control
Nil	None
S	Applicable (Pump inverter type)

Specifications (For details, please consult our "Product Specifications" information.)

Model	HRW002-H HRW002-HS	HRW008-H HRW008-HS	HRW015-H HRW015-HS	HRW030-H HRW030-HS		
Cooling method	Water-cooled					
Ambient temperature/humidity ^{Note 1)}	Temperature: 50 to 95°F (10 to 35°C), Humidity: 30 to 70%RH					
Circulating fluid system	Circulating fluid ^{Note 2)}	Fluorinert™ FC-40/GALDEN® HT200				
	Temperature range setting ^{Note 1)}	68 to 194°F (20 to 90°C)				
	Cooling capacity (50/60 Hz common) (kW)	2	8	15	29	
	Conditions	Circulating fluid temperature	Facility water temperature +27°F (15°C)			
		Facility water temperature	50 to 95°F (10 to 35°C)			
		Circulating fluid rated flow	1.1 gpm (4 L/min)	7.9 gpm (30 L/min)	10.6 gpm (40 L/min)	10.6 gpm (40 L/min)
		Facility water required flow rate	2.6 gpm (10 L/min)	5.3 gpm (20 L/min)	6.6 gpm (25 L/min)	10.6 gpm (40 L/min)
	Temperature stability ^{Note 3)}	±0.54°F (±0.3°C)				
	Pump capacity ^{Note 4)} (50/60 Hz)(MPa)	0.40/0.60 (at 4 L/min)	0.45/0.65 (at 30 L/min)	0.40/0.60 (at 40 L/min)	0.40/0.60 (at 40 L/min)	
	Circulating fluid flow range ^{Note 5)} (L/min)	0.8 to 4.2 gpm (3 to 16 L/min)		2.4 to 13.2 gpm (9 to 50 L/min)		
Tank capacity ^{Note 6)}	Approx. 3.4 gal (13 L)		Approx. 3.7 gal (14 L)			
Circulating fluid recovery tank volume ^{Note 7)}	3.2 gal (12 L)					
Port size	Rc3/4					
Wetted parts material	Copper brazing (Heat exchanger), Stainless steel, EPDM, Silicone, PPS, Fluororesin					
Facility water system	Temperature range	50 to 95°F (10 to 35°C)				
	Required flow rate ^{Note 8)}	2.6 gpm (10 L/min)	5.3 gpm (20 L/min)	6.6 gpm (25 L/min)	10.6 gpm (40 L/min)	
	Inlet pressure range	44 to 102 psi (0.3 to 0.7 MPa)				
	Port size	Rc3/4				
Wetted parts material	Copper brazing (Heat exchanger), Stainless steel, EPDM, Silicone, Bronze, Brass					
Electrical system	Power supply	3-phase 200/200 to 208 VAC ±10%				
	Max. operating current (A)	26				
	Breaker capacity (A)	30				
	Communications	Serial RS-485 (D-sub 9 pin) and Contact input/output (D-sub 25 pin)				
Dimensions ^{Note 9)}	W15 in (380mm) x D26.2 in (665mm) x H33.9 in (860 mm)					
Weight ^{Note 10)}	Approx. 198 lbs (90 kg)		Approx. 220 lbs (100 kg)			
Safety standards	UL, CE marking, SEMI (S2-0703, S8-1103, F47-0200), SEMATECH (S2-93, S8-95)					

Note 1) It should have no condensation.

Note 2) Fluorinert™ is a trademark of 3M and GALDEN® is a registered trademark of Solvay Solexis, Inc. Regarding the fluid other than the above, please contact SMC.

Note 3) Outlet temperature when the circulating fluid and facility water are rated flow, and the circulating fluid outlet and return port are directly connected. Installation environment, power supply, and facility water are within specification range and stable. Value obtained 10 minutes after the external load is stabilized. It may be out of ±0.54°F (±0.3°C) in some other operating conditions.

Note 4) The capacity at the circulating fluid outlet when the circulating fluid temperature is 68°F (20°C). Pump capacity at 60 Hz indicates the maximum capacity of the HRW□□□-HS (pump inverter type).

Note 5) Applicable to the HRW□□□-HS (pump inverter type) only.

Note 6) Minimum volume required for operating only the Thermo-chiller. (Circulating fluid temperature: 68°F (20°C), including the Thermo-chiller's internal pipings or heat exchanger)

Note 7) The automatic circulating fluid recovering function will be provided by selecting option Z for collecting the circulating fluid inside an external piping.

Note 8) Required flow rate for cooling capacity or maintaining the temperature stability.

Note 9) Panel dimensions. These dimensions do not include possible protrusions such as a breaker handle.

Note 10) Weight in the dry state without circulating fluids

Cooling Capacity

HRW002-H/008-H/015-H/030-H
HRW002-HS/008-HS/015-HS/030-HS

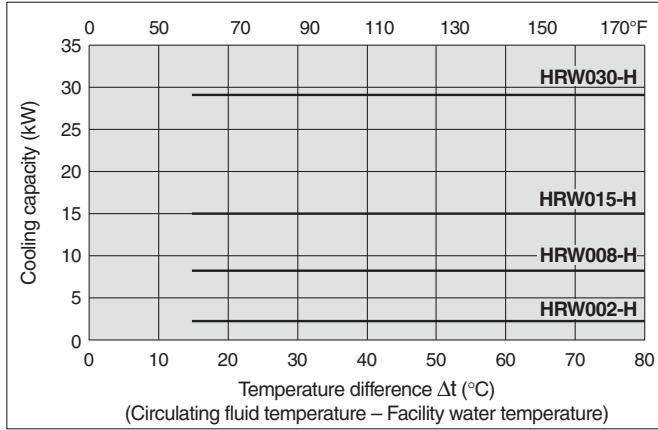

Heating Capacity

HRW002-H/008-H/015-H/030-H
HRW002-HS/008-HS/015-HS/030-HS

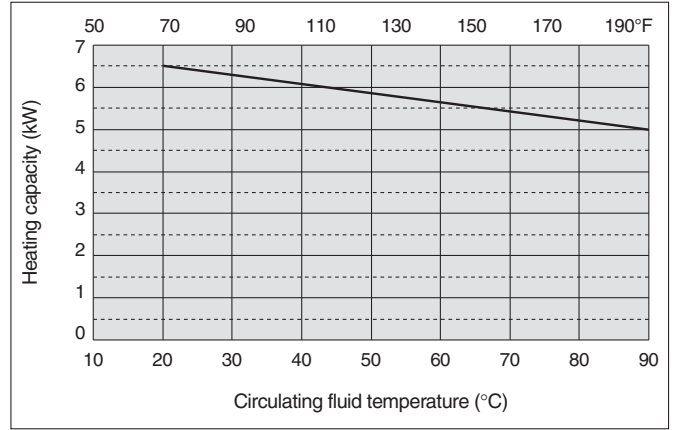

* When pump inverter is operating at frequency of 60 Hz (maximum).

Pump Capacity

HRW002-H
HRW002-HS
Circulating fluid: Fluorinated fluids
Circulating fluid temperature: 68°F (20°C)

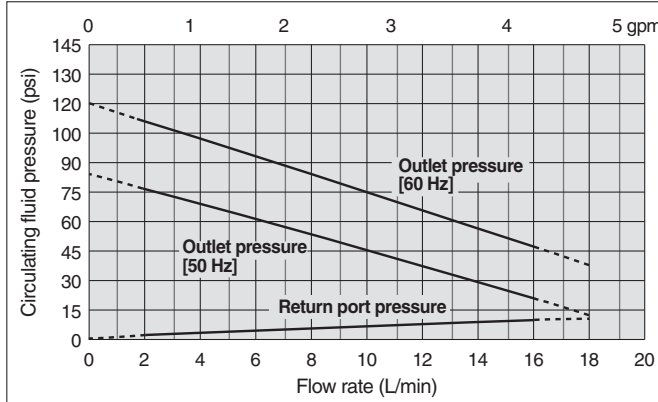

* If the circulating fluid flow drops below 0.53 gpm (2 L/min), the shutdown alarm activates and operation stops. Do not use the product when the flow exceeds 4.23 gpm (16 L/min), since the flow cannot be displayed accurately.
* Pump capacity at 60 Hz indicates the maximum capacity of the HRW002-HS (pump inverter type).

HRW008-H/015-H/030-H
HRW008-HS/015-HS/030-HS
Circulating fluid: Fluorinated fluids
Circulating fluid temperature: 68°F (20°C)

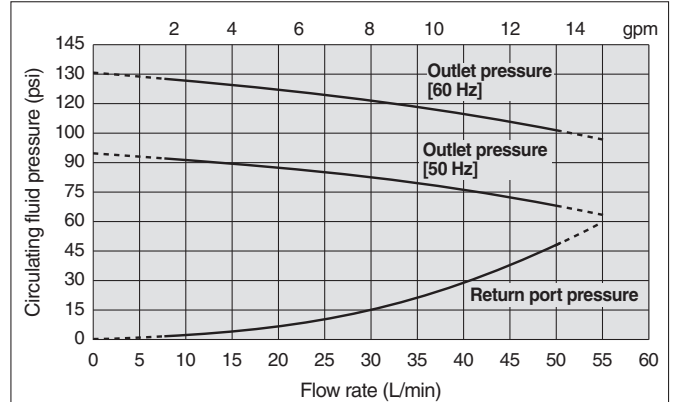

* If the circulating fluid flow drops below 2.1 gpm (8 L/min), the shutdown alarm activates and operation stops. Do not use the product when the flow exceeds 13.2 gpm (50 L/min), since the flow cannot be displayed accurately.
* Pump capacity at 60 Hz indicates the maximum capacity of the HRW008-HS/015-HS/030-HS (pump inverter type).

HRG
HRS
HRZ
HRZD
HRW
HEC
HEB
HED
Technical Data
Related Products

Thermo-chiller Ethylene Glycol Type

Series *HRW*



SEMI

How to Order

Ethylene Glycol Type

HRW 002 - H 1 -

Cooling capacity

Symbol	Cooling capacity
002	2 kW
008	8 kW
015	15 kW
030	30 kW

Temperature range setting

Symbol	Temperature range setting
H	68 to 194°F (20 to 90°C)

Ethylene glycol type

Option

Symbol	Option
Nil	None
C	Analog communication
D	DeviceNet communication
N	NPT fitting
Y	DI control kit
Z	Circulating fluid automatic recovery

Pump inverter control

Symbol	Pump inverter control
Nil	None
S	Applicable (Pump inverter type)

Specifications (For details, please consult our "Product Specifications" information.)

Model	HRW002-H1 HRW002-H1S	HRW008-H1 HRW008-H1S	HRW015-H1 HRW015-H1S	HRW030-H1 HRW030-H1S
Cooling method	Water-cooled			
Ambient temperature/humidity <small>Note 1)</small>	Temperature: 50 to 95°F (10 to 35°C), Humidity: 30 to 70%RH			
Circulating fluid <small>Note 2)</small>	60% ethylene glycol aqueous solution			
Temperature range setting <small>Note 1)</small>	68 to 194°F (20 to 90°C)			
Cooling capacity (50/60 Hz common) (kW)	2	8	15	27
Conditions	Circulating fluid temperature			
	Facility water temperature +27°F (15°C)			
	50 to 95 °F (10 to 35°C)			
	Circulating fluid rated flow	1.1 gpm (4 L/min)	4.0 gpm (15 L/min)	7.9 gpm (30 L/min)
Facility water required flow rate	2.6 gpm (10 L/min)	4.0 gpm (15 L/min)	6.6 gpm (25 L/min)	10.6 gpm (40 L/min)
Temperature stability <small>Note 3)</small>	±0.54°F (±0.3°C)			
Pump capacity <small>Note 4)</small> (50/60 Hz)	0.35/0.55 (at 4 L/min)	0.45/0.65 (at 15 L/min)	0.40/0.60 (at 30 L/min)	0.35/0.55 (at 40 L/min)
Circulating fluid flow range <small>Note 5)</small>	0.8 to 4.2 gpm (3 to 16 L/min)	2.4 to 13.2 gpm (9 to 50 L/min)		
Tank capacity <small>Note 6)</small>	Approx. 3.4 gal (13 L)			
Circulating fluid recovery tank volume <small>Note 7)</small>	3.2 gal (12 L)			
Port size	Rc3/4			
Wetted parts material	Nickel brazing (Heat exchanger), Stainless steel, EPDM, Silicone, PPS, Fluororesin			
Temperature range	50 to 95°F (10 to 35°C)			
Required flow rate <small>Note 8)</small>	2.6 gpml (10 L/min)	4.0 gpm (15 L/min)	6.6 gpm (25 L/min)	10.6 gpm (40 L/min)
Inlet pressure range	44 to 102 psi (0.3 to 0.7 MPa)			
Port size	Rc3/4			
Wetted parts material	Nickel brazing (Heat exchanger), Stainless steel, EPDM, Silicone, Bronze, Brass			
Power supply	3-phase 200/200 to 208 VAC ±10%			
Max. operating current (A)	26			
Breaker capacity (A)	30			
Communications	Serial RS-485 (D-sub 9 pin) and Contact input/output (D-sub 25 pin)			
Dimensions <small>Note 9)</small>	W15 in (380mm) x D 26.2 in (665mm) x H33.9 in (860mm)			
Weight <small>Note 10)</small>	Approx. 198 lbs (90 kg)			
Safety standards	UL, CE marking, SEMI (S2-0703, S8-1103, F47-0200), SEMATECH (S2-93, S8-95)			

Note 1) It should have no condensation.

Note 2) Dilute pure ethylene glycol with clear water. Additives invading wetting parts material such as preservatives cannot be used.

Note 3) Outlet temperature when the circulating fluid and facility water are rated flow, and the circulating fluid outlet and return port are directly connected. Installation environment, power supply, and facility water are within specification range and stable. Value obtained 10 minutes after the external load is stabilized (after stabilization with no load for HRW030-H1). It may be out of this range when a DI control kit (option Y) is used or in some other operating conditions.

Note 4) The capacity at the circulating fluid outlet when the circulating fluid temperature is 68°F (20°C). Pump capacity at 60 Hz indicates the maximum capacity of the HRW□□□-H1S (pump inverter type).

Note 5) Applicable to the HRW□□□-H1S (pump inverter type) only.

Note 6) Minimum volume required for operating only the Thermo-chiller. (Circulating fluid temperature: 68°F (20°C), including the Thermo-chiller's internal pipings or heat exchanger)

Note 7) The automatic circulating fluid recovering function will be provided by selecting option Z for collecting the circulating fluid inside an external piping.

Note 8) Required flow rate for cooling capacity or maintaining the temperature stability.

Note 9) Panel dimensions. These dimensions do not include possible protrusions such as a breaker handle.

Note 10) Weight in the dry state without circulating fluids

Cooling Capacity

HRW002-H1/008-H1/015-H1/030-H1
HRW002-H1S/008-H1S/015-H1S/030-H1S

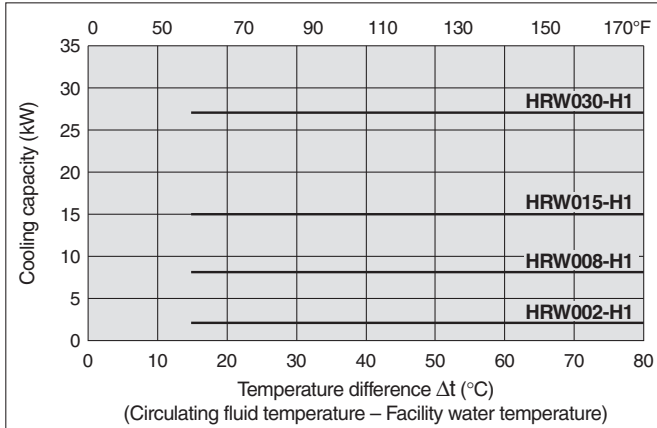

Heating Capacity

HRW002-H1/008-H1/015-H1/030-H1
HRW002-H1S/008-H1S/015-H1S/030-H1S

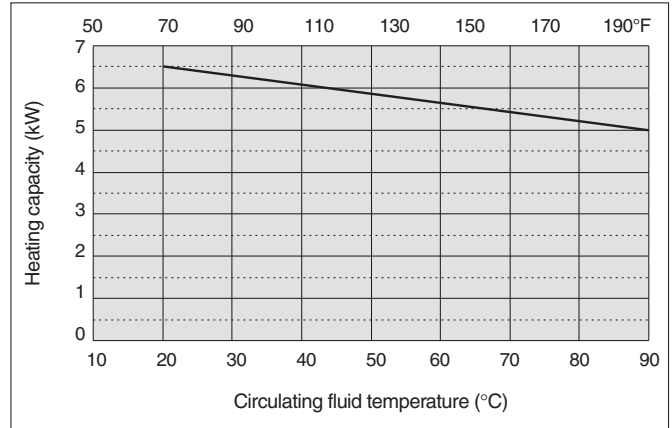

Pump Capacity

HRW002-H1
HRW002-H1S

Circulating fluid: 60% ethylene glycol
Circulating fluid temperature: 68°F (20°C)

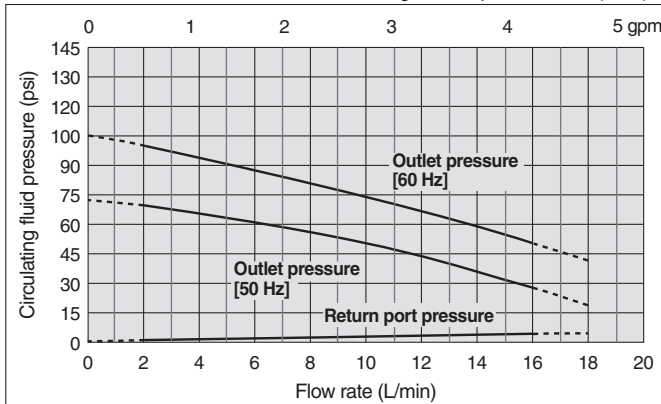

- * If the circulating fluid flow drops below 0.53 gpm (2 L/min), the shutdown alarm activates and operation stops. Do not use the product when the flow exceeds 4.23 gpm (16 L/min), since the flow cannot be displayed accurately.
- * Pump capacity at 60 Hz indicates the maximum capacity of the HRW002-H1S (pump inverter type).

HRW008-H1/015-H1/030-H1
HRW008-H1S/015-H1S/030-H1S

Circulating fluid: 60% ethylene glycol
Circulating fluid temperature: 68°F (20°C)

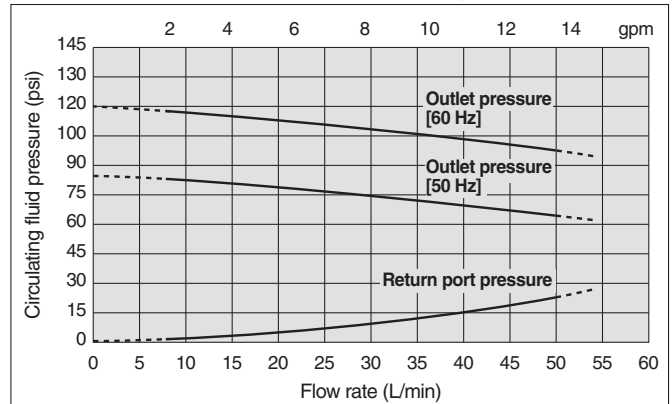

- * If the circulating fluid flow drops below 2.1 gpm (8 L/min), the shutdown alarm activates and operation stops. Do not use the product when the flow exceeds 13.2 gpm (50 L/min), since the flow cannot be displayed accurately.
- * Pump capacity at 60 Hz indicates the maximum capacity of the HRW008-H1S/015-H1S/030-H1S (pump inverter type).

HRG
HRS
HRZ
HRZD
HRW
HEC
HEB
HED
Technical Data
Related Products

Thermo-chiller Clear/Deionized Water Type

Series *HRW*



SEMI

How to Order

Clear/Deionized Water Type

HRW 002 - H 2 - [] - []

Cooling capacity ↓

Symbol	Cooling capacity
002	2 kW
008	8 kW
015	15 kW
030	30 kW

Temperature range setting ↓

Symbol	Temperature range setting
H	68 to 194°F (20 to 90°C)

Clear/Deionized water type ↓

Option ↓

Symbol	Option
Nil	None
C	Analog communication
D	DeviceNet communication
N	NPT fitting
Y	DI control kit
Z	Circulating fluid automatic recovery

Pump inverter control ↓

Symbol	Pump inverter control
Nil	None
S	Applicable (Pump inverter type)

Specifications (For details, please consult our "Product Specifications" information.)

Model	HRW002-H2 HRW002-H2S	HRW008-H2 HRW008-H2S	HRW015-H2 HRW015-H2S	HRW030-H2 HRW030-H2S		
Cooling method	Water-cooled					
Ambient temperature/humidity <small>Note 1)</small>	Temperature: 50 to 95°F (10 to 35°C), Humidity: 30 to 70%RH					
Circulating fluid system	Circulating fluid <small>Note 2)</small>	Clear water, Deionized water				
	Temperature range setting <small>Note 1)</small>	68 to 194°F (20 to 90°C)				
	Cooling capacity (50/60 Hz common) (kW)	2	8	15	30	
	Conditions	Circulating fluid temperature	Facility water temperature +27°F (15°C)			
		Facility water temperature	50 to 95°C (10 to 35°C)			
		Circulating fluid rated flow	1.1 gpm (4 L/min)	4.0 gpm (15 L/min)	7.9 gpm (30 L/min)	10.6 gpm (40 L/min)
		Facility water required flow rate	2.6 gpm (10 L/min)	4.0 gpm (15 L/min)	6.6 gpm (25 L/min)	10.6 gpm (40 L/min)
	Temperature stability <small>Note 3)</small>	±0.54°F (±0.3°C)				
	Pump capacity <small>Note 4)</small> (50/60 Hz)	0.35/0.55 (at 4 L/min)	0.45/0.65 (at 15 L/min)	0.40/0.60 (at 30 L/min)	0.35/0.55 (at 40 L/min)	
	Circulating fluid flow range <small>Note 5)</small>	0.8 to 4.2 gpm (3 to 16 L/min)	2.4 to 13.2 gpm (9 to 50 L/min)			
Tank capacity <small>Note 6)</small>	Approx. 3.4 gal (13 L)					
Circulating fluid recovery tank volume <small>Note 7)</small>	3.2 gal (12 L)					
Port size	Rc3/4					
Wetted parts material	Nickel brazing (Heat exchanger), Stainless steel, EPDM, Silicone, PPS, Fluororesin					
Facility water system	Temperature range	50 to 95°F (10 to 35°C)				
	Required flow rate <small>Note 8)</small>	2.6 gpm (10 L/min)	4.0 gpm (15 L/min)	6.6 gpm (25 L/min)	10.6 gpm (40 L/min)	
	Inlet pressure range	44 to 102 psi (0.3 to 0.7 MPa)				
	Port size	Rc3/4				
Wetted parts material	Nickel brazing (Heat exchanger), Stainless steel, EPDM, Silicone, Bronze, Brass					
Electrical system	Power supply	3-phase 200/200 to 208 VAC ±10%				
	Max. operating current (A)	26				
	Breaker capacity (A)	30				
	Communications	Serial RS-485 (D-sub 9 pin) and Contact input/output (D-sub 25 pin)				
Dimensions <small>Note 9)</small>	W15in (380 mm) x D 26.2 in (665 mm) x H33.9 in (860 mm)					
Weight <small>Note 10)</small>	Approx. 198 lbs (90 kg)					
Safety standards	UL, CE marking, SEMI (S2-0703, S8-1103, F47-0200), SEMATECH (S2-93, S8-95)					

Note 1) It should have no condensation.

Note 2) If clear water or deionized water is used, please use water that conforms to Water Quality Standards of the Japan Refrigeration and Air Conditioning Industry Association (JRA GL-02-1994/cooling water system - circulation type - make-up water). The electrical conductivity of the deionized water used as the fluid varies depending on the operating conditions.

Note 3) Outlet temperature when the circulating fluid and facility water are rated flow, and the circulating fluid outlet and return port are directly connected. Installation environment, power supply, and facility water are within specification range and stable. Value obtained 10 minutes after the external load is stabilized (after stabilization with no load for HRW030-H2). It may be out of this range when a DI control kit (option Y) is used or in some other operating conditions.

Note 4) The capacity at the circulating fluid outlet when the circulating fluid temperature is 68°F (20°C). Pump capacity at 60 Hz indicates the maximum capacity of the HRW□□□-H2S (pump inverter type).

Note 5) Applicable to the HRW□□□-H2S (pump inverter type) only.

Note 6) Minimum volume required for operating only the Thermo-chiller. (Circulating fluid temperature: 68°F (20°C), including the Thermo-chiller's internal pipings or heat exchanger)

Note 7) The automatic circulating fluid recovering function will be provided by selecting option Z for collecting the circulating fluid inside an external piping.

Note 8) Required flow rate for cooling capacity or maintaining the temperature stability. Note 9) Panel dimensions. These dimensions do not include possible protrusions such as a breaker handle.

Note 10) Weight in the dry state without circulating fluids



Cooling Capacity

HRW002-H2/008-H2/015-H2/030-H2
HRW002-H2S/008-H2S/015-H2S/030-H2S

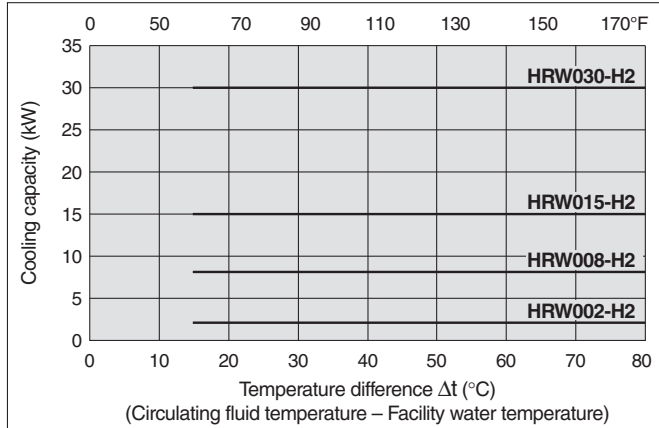

Heating Capacity

HRW002-H2/008-H2/015-H2/030-H2
HRW002-H2S/008-H2S/015-H2S/030-H2S

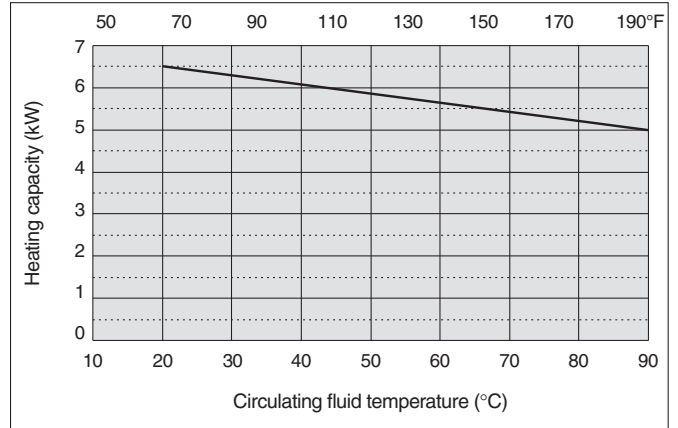

Pump Capacity

HRW002-H2
HRW002-H2S

Circulating fluid: Clear water
Circulating fluid temperature: 68°F (20°C)

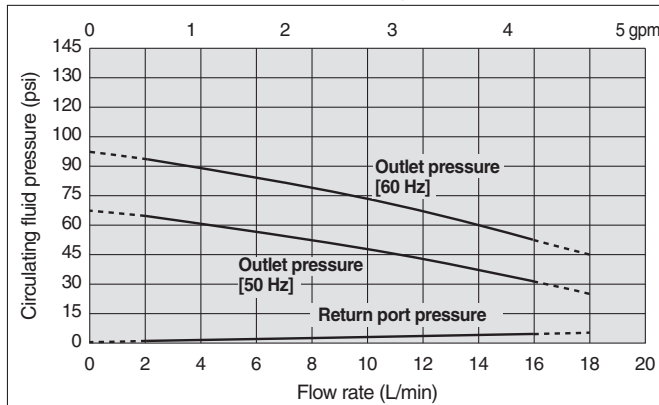

- * If the circulating fluid flow drops below 0.53 gpm (2 L/min), the shutdown alarm activates and operation stops. Do not use the product when the flow exceeds 4.23 gpm (16 L/min), since the flow cannot be displayed accurately.
- * Pump capacity at 60 Hz indicates the maximum capacity of the HRW002-H2S (pump inverter type).

HRW008-H2/015-H2/030-H2
HRW008-H2S/015-H2S/030-H2S

Circulating fluid: Clear water
Circulating fluid temperature: 68°F (20°C)

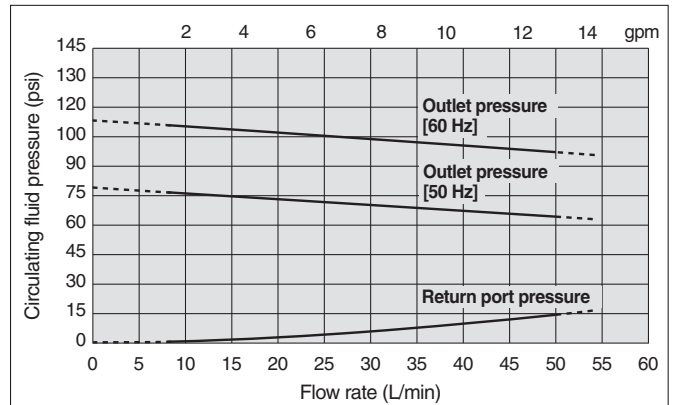

- * If the circulating fluid flow drops below 2.1 gpm (8 L/min), the shutdown alarm activates and operation stops. Do not use the product when the flow exceeds 13.2 gpm (50 L/min), since the flow cannot be displayed accurately.
- * Pump capacity at 60 Hz indicates the maximum capacity of the HRW008-H2S/015-H2S/030-H2S (pump inverter type).

HRG
HRS
HRZ
HRZD
HRW
HEC
HEB
HED
Technical Data
Related Products

Series HRW

Common Specifications

Dimensions

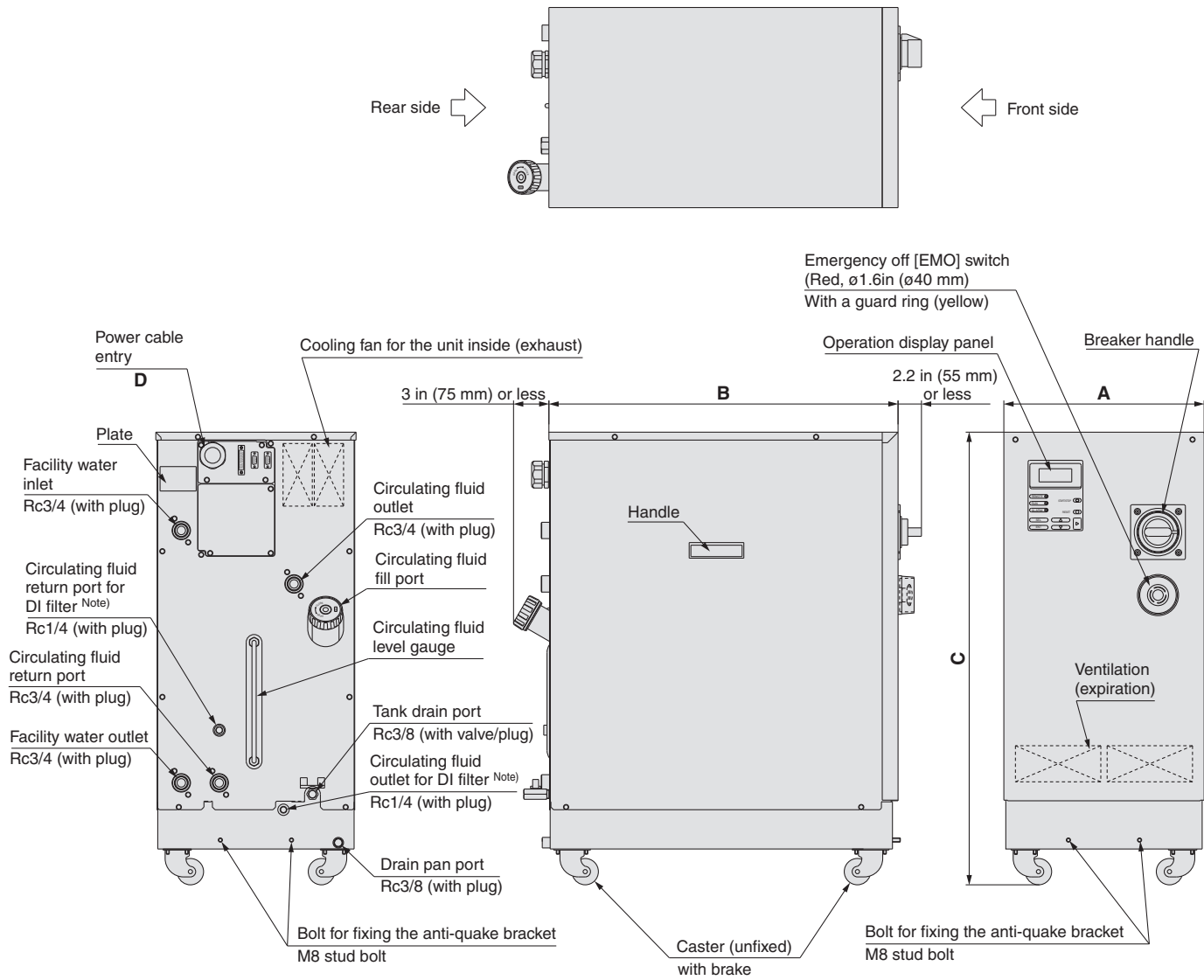

Note) Only when the DI control kit (option Y) is selected.

Unit: Inch (mm)

Model			A	B	C	D
Fluorinated fluid type	Ethylene glycol type	Clear/Deionized water type				
HRW002-H	HRW002-H1	HRW002-H2	15 (380)	26.2 (665)	33.9 (860)	$\phi 0.7 \times 0.81$ ($\phi 18.5$ to 20.5)
HRW008-H	HRW008-H1	HRW008-H2				
HRW015-H	HRW015-H1	HRW015-H2				
HRW030-H	HRW030-H1	HRW030-H2				

Communication Function (For details, please consult our "Communication Specifications" information.)

Contact Input/Output

Item	Specifications	
Connector no.	P1	
Connector type (on this product side)	D-sub 25 P type, Female connector	
Fixing bolt size	M2.6 x 0.45	
Input signal	Insulation method	Photocoupler
	Rated input voltage	24 VDC
	Operating voltage range	21.6 to 26.4 VDC
	Rated input current	5 mA TYP
	Input impedance	4.7 kΩ
Output signal	Rated load voltage	48 VAC or less/30 VDC or less
	Maximum load current (total)	When using the power supply of the Thermo-chiller: 200 mA DC (resistance load/inductive load) When using the power supply of the customer's machine: 800 mA AC/DC (resistance load/inductive load)
Alarm signal	Rated load voltage	48 VAC or less/30 VDC or less
	Maximum load current	800 mA AC/DC (resistance load/inductive load)
EMO signal	Rated load voltage	48 VAC or less/30 VDC or less
	Maximum load current	800 mA AC/DC (resistance load/inductive load)

Circuit diagram

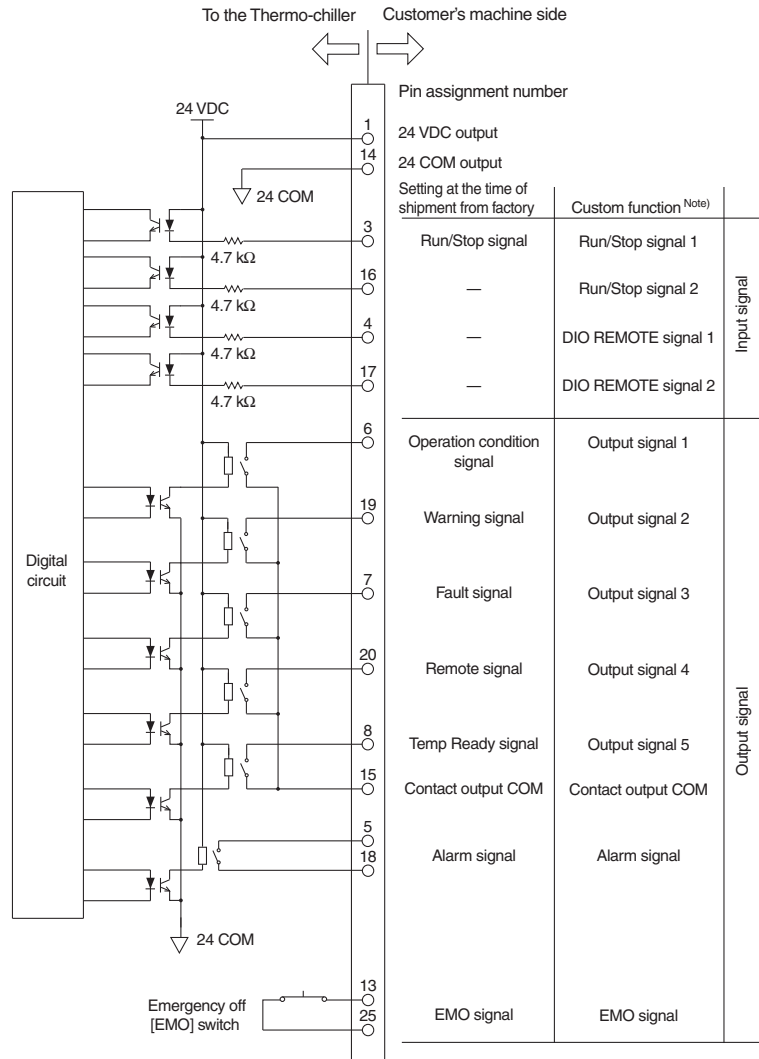

Note) The custom function is equipped for contact input/output. Using the custom function enables the customer to set the signal type for contact input/output or pin assignment numbers. For details, please consult "Communication Specifications" information.

HRG
HRS
HRZ
HRZD
HRW
HEC
HEB
HED
Technical Data
Related Products

Series HRW

Communication Function (For details, please consult our "Communication Specifications" information.)

Serial RS-485

The serial RS-485 enables the following items to be written and read out.

<Writing>

Run/Stop

Circulating fluid temperature setting

Circulating fluid automatic recovery start/stop*¹

<Readout>

Circulating fluid present temperature

Circulating fluid flow

Circulating fluid discharge pressure

Circulating fluid electrical resistivity*²

Alarm occurrence information

Status (operating condition) information

*¹ Only when the circulating fluid automatic recovery function (option Z) is selected.

*² Only when the DI control kit (option Y) is selected.

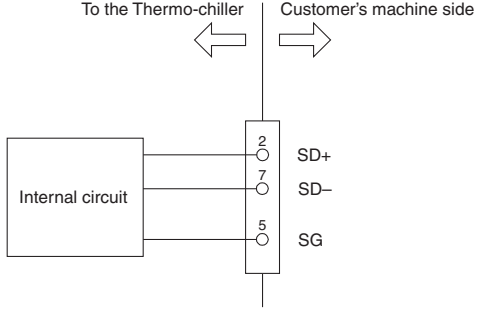
Item	Specifications
Connector no.	P2
Connector type (on this product side)	D-sub 9 P type, Female connector
Fixing bolt size	M2.6 x 0.45
Standards	EIA RS485
Protocol	Modicon Modbus
Circuit diagram	

Connector location

P3: Not used for the maintenance purpose port
D-sub 9 (Male receptacle)

P2: Serial RS-485
D-sub 9 (Female receptacle)

P1: Contact input/output
D-sub 25 (Female receptacle)

Power cable entry

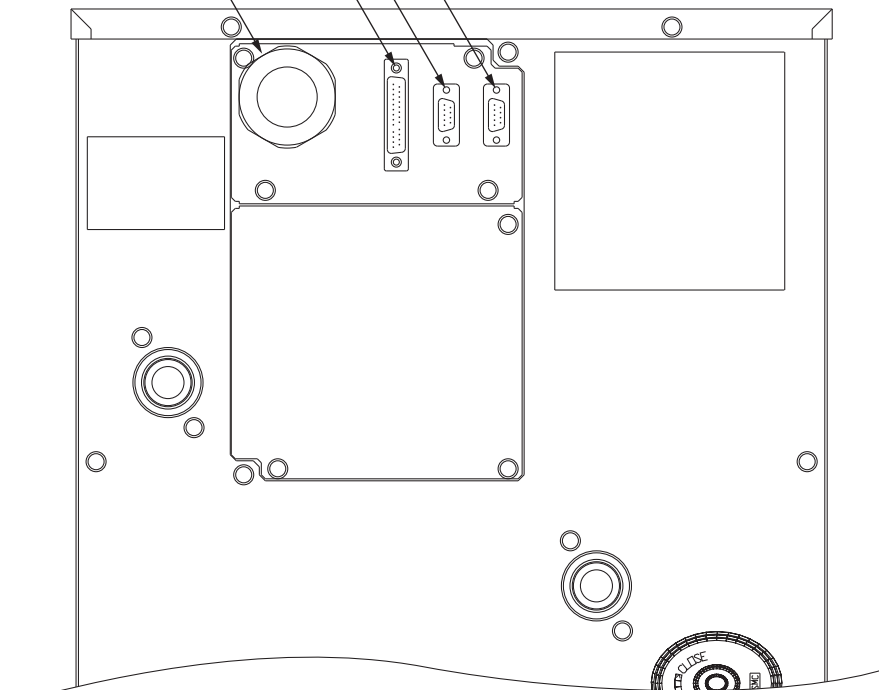

Rear side

Operation Display Panel

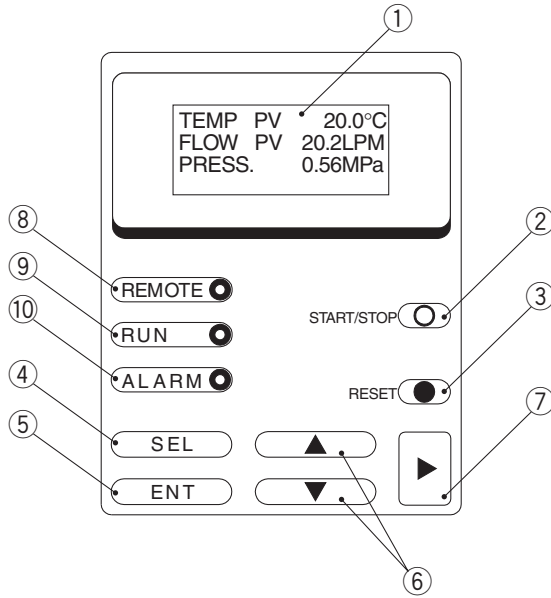

No.	Description	Function
①	LCD	Operating condition of this unit/Circulating fluid discharge temperature/Circulating fluid flow/ Circulating fluid discharge pressure/Setting value/Alarm message, etc. are displayed.
②	[START/STOP] key	Starts/Stops the operation.
③	[RESET] key	Stops the alarm buzzing. Resets the alarm.
④	[SEL] key	Switches the display.
⑤	[ENT] key	Decides the settings.
⑥	[▲][▼] key	Moves the cursor and changes the setting values.
⑦	[▶] key	Moves the cursor.
⑧	[REMOTE] indicator	Lights up when the unit is in the remote status.
⑨	[RUN] indicator	Lights up when the unit is in the operating status.
⑩	[ALARM] indicator	Lights up when the unit is alarming.

Alarm

This unit can display 23 kinds of alarm messages as standard. Also, it can read out the serial RS-485 communication.

Alarm code	Alarm message	Operation status	Main reason
01	Water Leak Detect FLT	Stop	Liquid deposits in the drain pan of this unit.
02	Incorrect Phase Error FLT	Stop	The power supply to this unit is incorrect.
05	Reservoir Low Level FLT	Stop	The amount of circulating fluid tank is running low.
06	Reservoir Low Level WRN	Continue	The amount of circulating fluid tank is running low.
07	Reservoir High Level WRN	Continue	The amount of circulating fluid in the tank has increased.
08	Temp. Fuse Cutout FLT	Stop	Temperature of the circulating fluid tank is raised.
09	Reservoir High Temp. FLT	Stop	Temperature of the circulating fluid has exceeded the limitation.
10	Return High Temp. WRN	Continue	Temperature of returning circulating fluid has exceeded the limit.
11	Reservoir High Temp. WRN	Continue	Temperature of the circulating fluid has exceeded the limitation set by the customer.
12	Return Low Flow FLT	Stop	The circulating fluid flow has gone below the limit.
13	Return Low Flow WRN	Continue	Flow rate of the Thermo-chiller has dropped below the set value.
15	Pump Breaker Trip FLT	Stop	The protective equipment in the circulating fluid driving line has started.
17	Interlock Fuse Cutout FLT	Stop	Overcurrent is flown to the control circuit.
18	DC Power Fuse Cutout WRN	Continue	Overcurrent has flowed to the (optional) solenoid valve. (Only for the automatic circulating fluid recovery function - option Z)
19	FAN Motor Stop WRN	Continue	Cooling fan inside the compressor has stopped.
21	Controller Error FLT	Stop	The error occurred in the control systems.
22	Memory Data Error FLT	Stop	The data stored in the controller of this unit went wrong.
23	Communication Error WRN	Continue	The serial communications between this unit and customer's system has been suspended.
24	DI Low Level WRN	Continue	DI level of the circulating fluid has gone below the limitation set by the customer. (Only for DI control kit - option Y)
25	Pump Inverter Error FLT	Stop	The error occurred in the circulating pump inverter. This alarm is applicable to the HRW□□□-H□S only.
26	DNET Comm. Error FLT	Stop	The DeviceNet communications between this unit and customer's system has been suspended. (Only for DeviceNet communication specification - option D)
27	DNET Comm. Error WRN	Continue	An error has occurred in the DeviceNet communication system of this unit. (Only for DeviceNet communication specification - option D)
29	F.Water Low Temp. WRN	Continue	Temperature of facility water has dropped below the set temperature.
30	F.Water High Temp. WRN	Continue	Temperature of facility water has exceeded the set temperature.

HRG

HRS

HRZ

HRZD

HRW

HEC

HEB

HED

Technical Data

Related Products

Series HRW Options

Note) Options have to be selected when ordering the Thermo-chiller. It is not possible to add them after purchasing the unit.

C Option symbol Analog Communication

HRW - - - C
Analog communication

In addition to the standard contact input/output signal communication and the serial RS-485 communication, analog communication function can be added. The analog communication function enables to write and read out the following items.

<Writing>	<Readout>
Circulating fluid temperature setting	Circulating fluid present temperature
	Electrical resistivity*

* Only when the DI control kit (option Y) is selected.

Scaling voltage - circulating fluid temperature can be set arbitrarily by the customer.
For details, please consult our "Communication Specifications" information.

D Option symbol DeviceNet Communication

HRW - - - D *DeviceNet™*
DeviceNet communication

In addition to the standard contact input/output signal communication and the serial RS-485 communication, DeviceNet function can be added. DeviceNet function enables to write and read out the following items.

<Writing>	<Readout>
Run/Stop	Circulating fluid present temperature
Circulating fluid temperature setting	Circulating fluid flow
Circulating fluid automatic recovery start/stop* ¹	Circulating fluid discharge pressure
	Electrical resistivity* ²
	Alarm occurrence information
	Status (operating condition) information

*¹ Only when the circulating fluid automatic recovery function (option Z) is selected.

*² Only when the DI control kit (option Y) is selected.

For details, please consult our "Communication Specifications" information.

N Option symbol NPT Fitting

HRW - - - N
NPT fitting

An adapter is included to change the connection parts of circulating fluid piping and facility water piping to NPT thread type. The adapter must be installed by the customer.

Y Option symbol DI Control Kit

HRW - - - Y
DI control kit

Select this option if you want to maintain the electrical resistivity (DI level) of the circulating fluid at a certain level. However, some components have to be fitted by customer. For details, refer to specification table for this option.

Please note that this is not applicable to the fluorinated liquid type.

Applicable model		HRW0 <input type="checkbox"/> <input type="checkbox"/> -H1-Y	HRW0 <input type="checkbox"/> <input type="checkbox"/> -H2-Y
Allowable circulating fluid	—	60% ethylene glycol aqueous solution	Deionized water
DI level display range	MΩ·cm	0 to 20	
DI level set range	MΩ·cm	0 to 20 ^{Note)}	
Solenoid valve hysteresis for control	MΩ·cm	0 to 0.9	
DI level reduction alarm set range	MΩ·cm	0 to 20	

Note) The DI filter is needed to control the DI level. (SMC Part No.: HRZ-DF001)

Please purchase additionally because the DI filter is not included in this option. Also, if necessary, additionally purchase the insulating material for the DI filter. (SMC Part No.: HRZ-DF002)

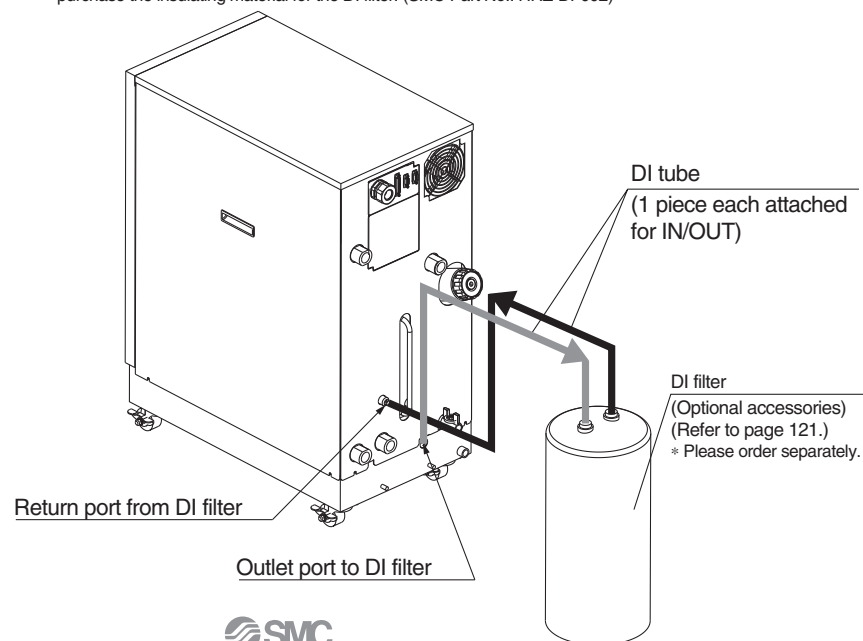

* Install the DI filter outside the Thermo-chiller for piping. Secure the space for installing the DI filter in the rear side of the Thermo-chiller.

* It may go outside of the temperature stability range of ±0.3°C when this option is used in some operating conditions.

Z Option symbol**Circulating Fluid Automatic Recovery**

HRW - - - **Z**

●
Circulating fluid
automatic recovery

Select this option for customers who want to use the circulating fluid automatic recovery function.

The automatic recovery function is a device which can recover the circulating fluid inside pipings into a sub-tank of the Thermo-chiller by the external communication or operation display panel.

Some components need to be fitted by the customer. For details, consult "Product Specifications" information for these options.

Applicable model	Common for all models
Circulating fluid recoverable volume ^{Note 1)}	3.2 gal (12 L)
Purge gas	Nitrogen gas
Purge gas supply port	Self-align fitting for O.D. $\phi 0.3$ in ($\phi 8$ mm) ^{Note 2)}
Purge gas supply pressure	58 to 102 psi (0.4 to 0.7 MPa)
Purge gas filtration	0.01 or less
Regulator set pressure	22 to 44 psi (0.15 to 0.3 MPa) ^{Note 3)}
Recoverable circulating fluid temperature	50 to 104°F (10 to 40°C)
Recovery start/stop	Start: External communication ^{Note 4)} or operation display panel/Stop: Automatic
Timeout error	Timer from recovery start to completion Stops recovering when the timer turns to set time. Possible set range: 60 to 300 sec, at the time of shipping from the factory: 300 sec
Height difference with the customer system side	32.8 ft (10 m) or less

Note 1) This is the space volume of the sub-tank when the liquid level of the circulating fluid is within the specification. Guideline of the recovery volume is 80% of the circulating fluid recoverable volume.

Note 2) Before piping, clean inside the pipings with air blow, etc. Use the piping with no dust generation by purge gas. When using resin tube, where necessary, use insert fittings, etc. in order not to deform the tubings when connecting to self-align fittings.

Note 3) At the time of shipping from factory, it is set to 29 psi (0.2 MPa).

Note 4) For details, please consult our "Communication Specifications" information.

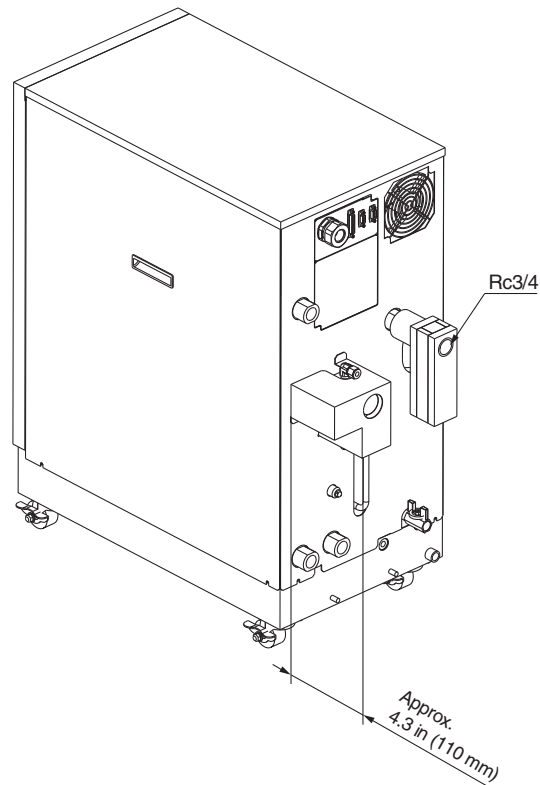

HRG

HRS

HRZ

HRZD

HRW

HEC

HEB

HED

Technical
DataRelated
Products

Series HRW

Optional Accessories

By-pass Piping Set

Note) Necessary to be fitted by the customer.

When the circulating fluid goes below the rated flow, cooling capacity will be reduced and the temperature stability will be badly affected. In such a case, use the by-pass piping set.

Part no.	Applicable model
HRW-BP001	Common for all models

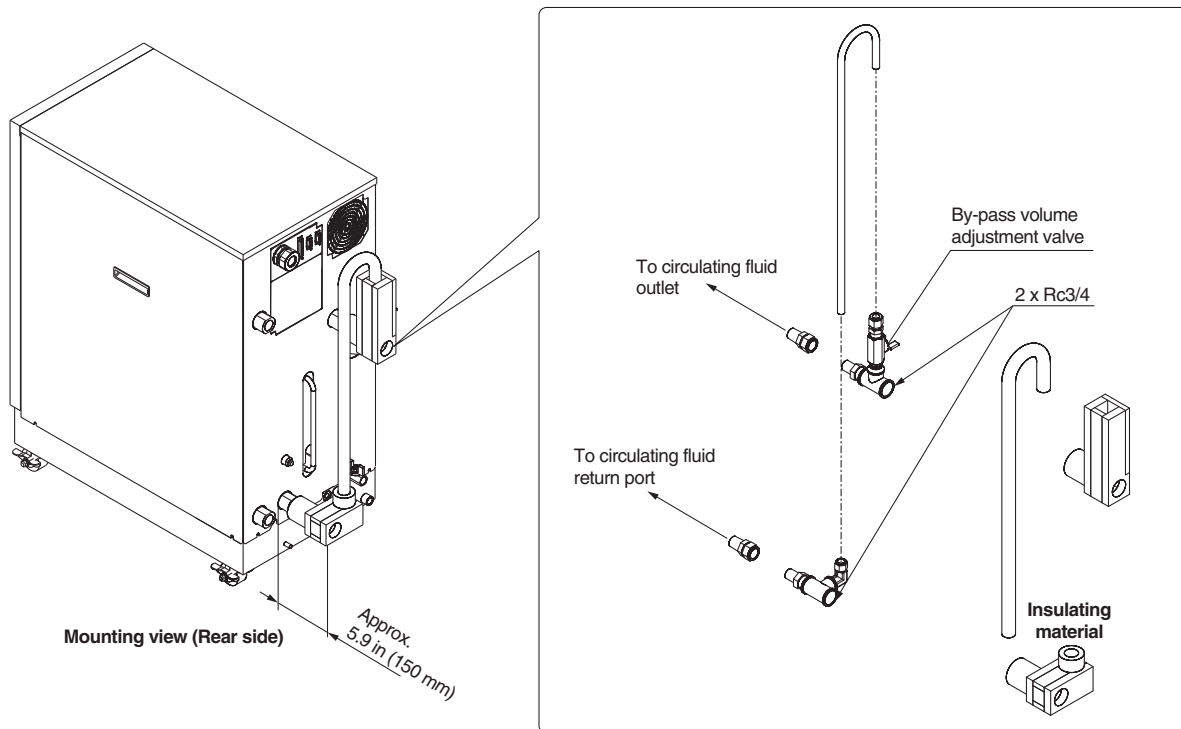

Anti-quake Bracket

Unit: in (mm)

Bracket for earthquakes
Prepare the anchor bolts (M12) which are suited to the floor material by the customer.

Part no.	Applicable model
HRZ-TK002	Common for all models

Note) 2 pieces per set (for 1 unit) (HRZ-TK002)

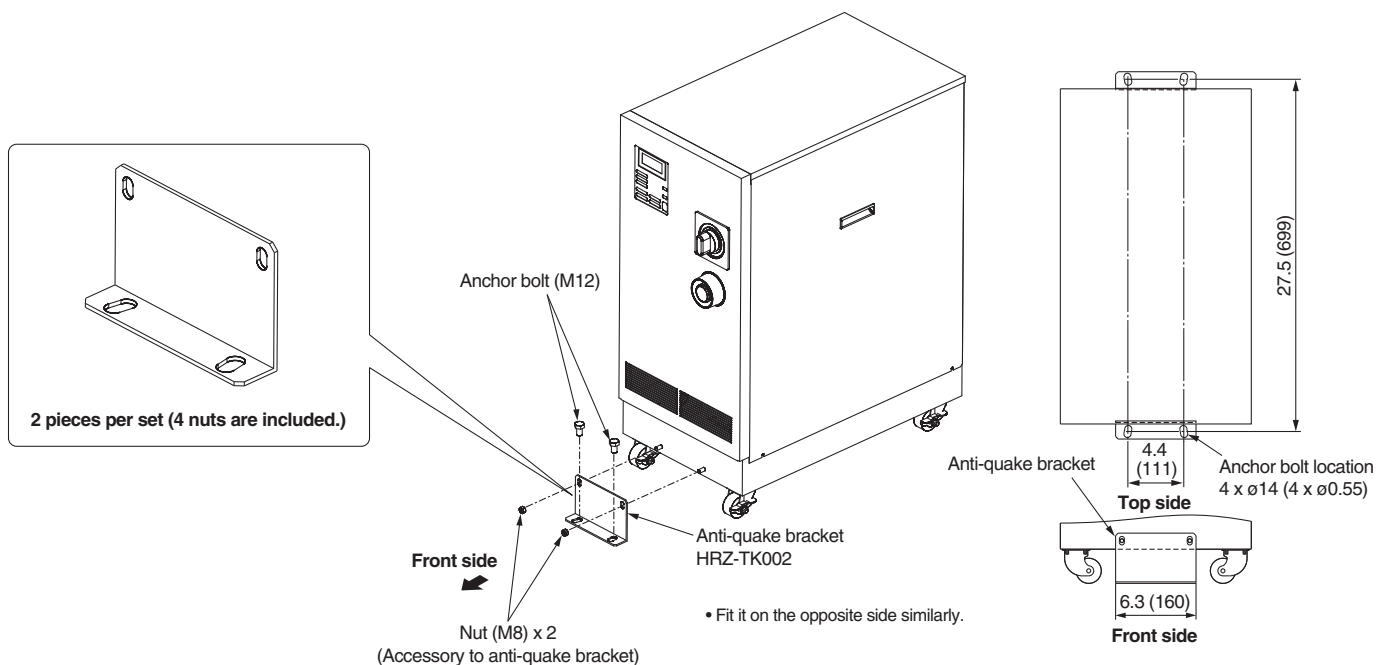

4-Port Manifold

4-branching the circulating fluid enables 4 temperature controls at the maximum with the 1 unit Thermo-chiller. Order the heat insulator for 4 port manifold (HRW-MA002) separately if necessary.

Part no.	Applicable model
HRW-MA001	Common for all models
HRW-MA002	

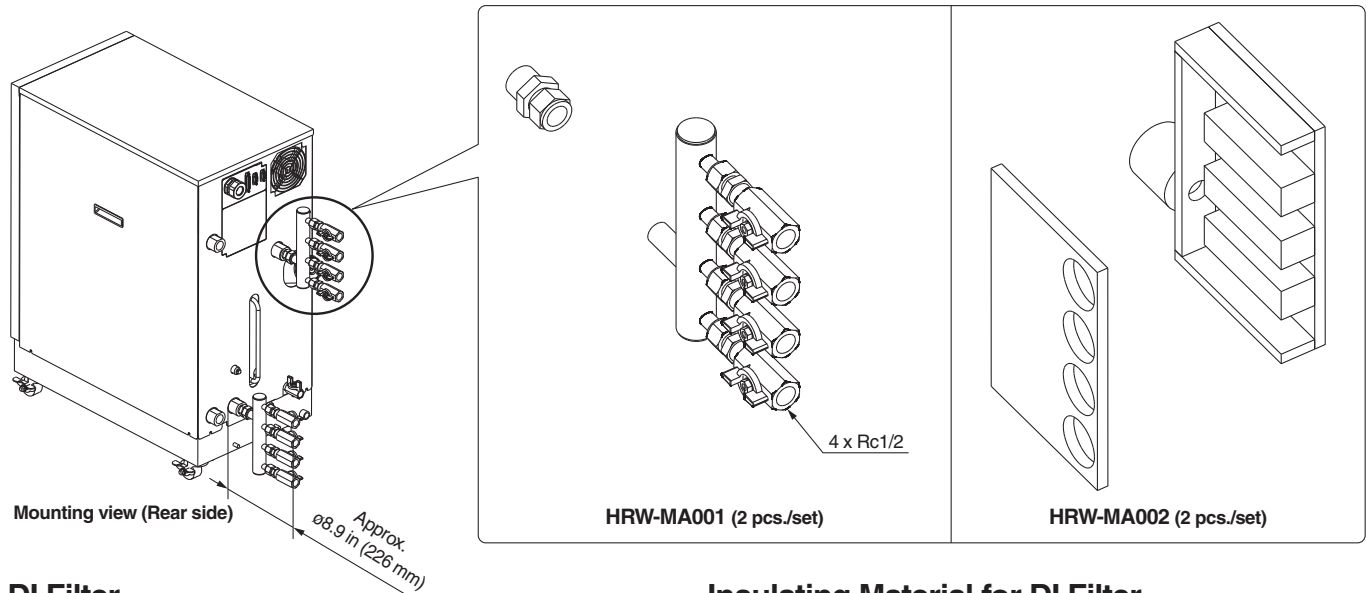

DI Filter

This is the ion replacement resin to maintain the electric resistivity of the circulating fluid. Customers who selected the DI control kit (option Y) need to purchase the DI filter separately.

Insulating Material for DI Filter

When the DI filter is used at a high temperature, we recommend that you use this insulating material to protect the radiated heat from the DI filter or possible burns. We also recommend that you use this to prevent heat absorption from the DI filter and to avoid forming condensation.

Part no.	Applicable model
HRZ-DF002	Common for all models which can select the DI control kit. (option Y)

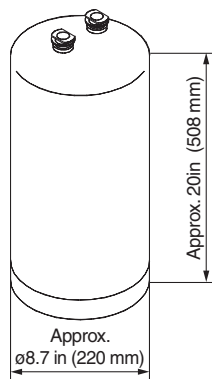

Weight: Approx. 44 lbs (20 kg)

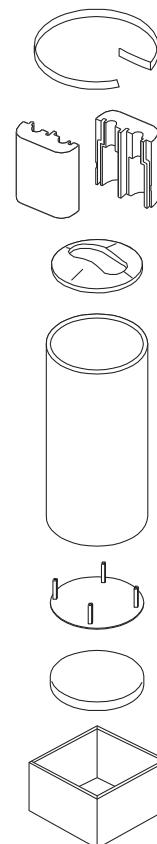

HRG

HRS

HRZ

HRZD

HRW

HEC

HEB

HED

Technical Data

Related Products

Series HRW

Contaminant Filter

A filter mounted in the circulating fluid circuit to eliminate the dust which is contained in the circulating fluid. (Filtration: 20 μm) It is provided with its own heat insulator.

Part no.	Applicable model
HRW-CF001	Common for all models
HRW-CF002	

Note) The internal element of the contaminant filter (Part no.: HRW-CF002) is a replacement part. The period in service depends on the operating conditions.

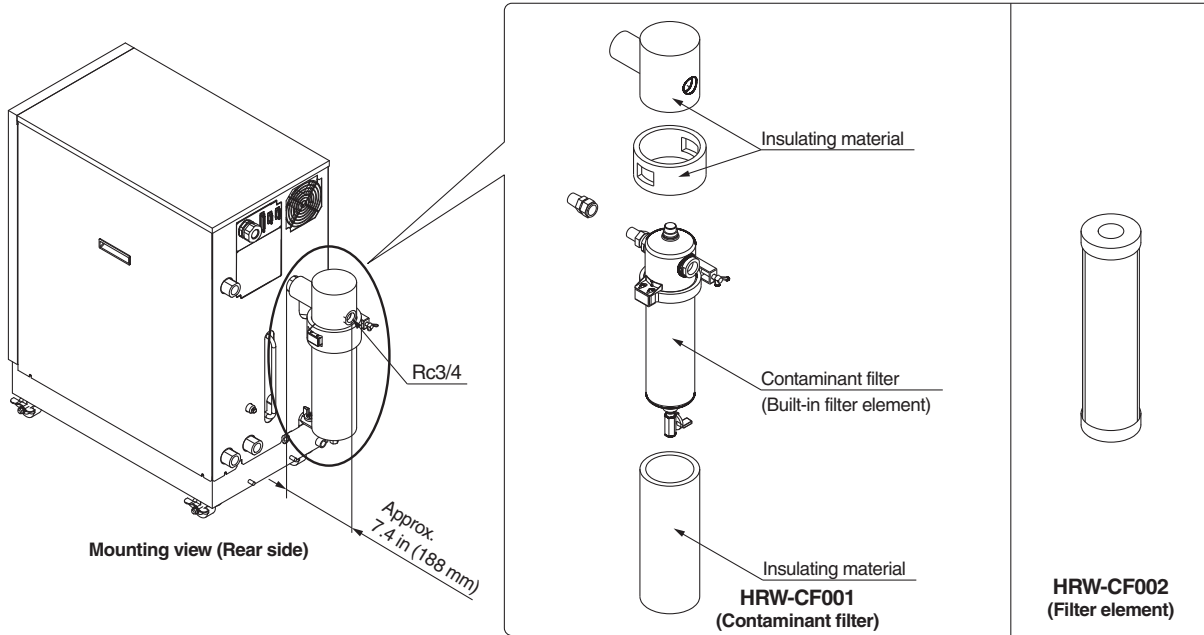

60% Ethylene Glycol Aqueous Solution

This solution can be used as a circulating fluid for ethylene glycol-type Thermo-chillers. (Capacity: 2.6 gal (10 L))

Part no.	Applicable model
HRZ-BR001	Common for all ethylene glycol-type models

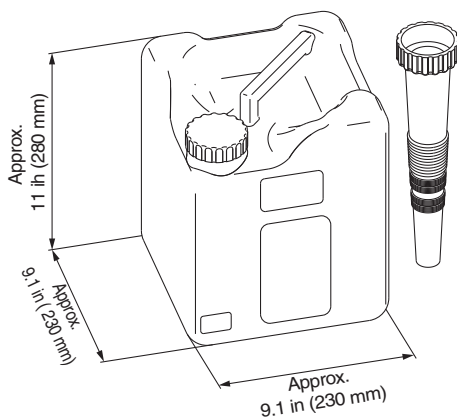

Concentration Meter

This meter can be used to control the concentration of ethylene glycol aqueous solution regularly.

Part no.	Applicable model
HRZ-BR002	Common for all ethylene glycol-type models

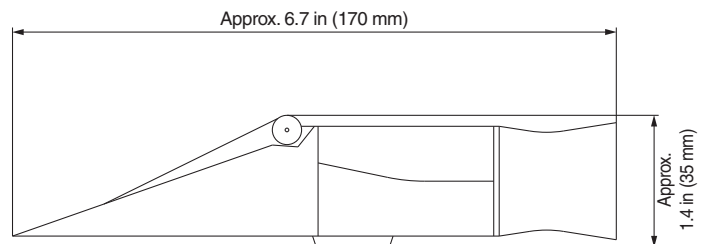



Series HRW Specific Product Precautions 1

Be sure to read this before handling. Refer to back page 1 for Safety Instructions and back pages 2 to 5 for Temperature Control Equipment Precautions.

Design

Warning

1. This catalog shows the specifications of a single unit.

- For details, please consult our "Product Specifications" and thoroughly consider the adaptability between the customer's system and this unit.
- Although the protection circuit as a single unit is installed, the customer is requested to carry out the safety design for the whole system.

Selection

Caution

1. Model selection

In order to select the correct Thermo-chiller model, the amount of thermal generation from the customer's system, the operating circulating fluid, and its circulating flow are required. Select a model, by referring to the guideline to model selection on page 104.

2. Option selection

Options have to be selected when ordering the Thermo-chiller. It is not possible to add them after purchasing the unit.

Handling

Warning

1. Thoroughly read the Operation Manual.

Read the Operation Manual completely before operation, and keep this manual available whenever necessary.

Operating Environment/Storage Environment

Caution

1. Do not use in the following environment because it will lead to a breakdown.

- Environment like written in "Temperature Control Equipment Precautions."
- Locations where spatter will adhere to when welding.
- Locations where it is likely that the leakage of flammable gas may occur.
- Locations where the ambient temperature exceeds the limits as mentioned below.
During operation 50 to 95°F (10 to 35°C)
During storage 32 to 122°F (0 to 50°C) (but as long as water or circulating fluid are not left inside the pipings)
- Locations where the ambient relative humidity exceeds the limit as mentioned below.
During operation 30% to 70%
During storage 15% to 85%
- (Inside the operation facilities) locations where there is not sufficient space for maintenance.
- In locations where the ambient pressure exceeds the atmospheric pressure.

2. The Thermo-chiller does not have clean room specification. It generates dust from the pump inside the unit and the cooling fan for the unit inside.

Circulating Fluid

Caution

- Avoid oil or other foreign objects entering the circulating fluid.
- Use ethylene glycol that does not contain additives such as preservatives.
- The condensation of ethylene glycol aqueous solution must be 60% or less. If the condensation is too high, the pump will be overloaded, resulting in occurrence of "Pump Breaker Trip FLT".
- Avoid water moisture entering the fluorinated fluid.
- Use clear water (including for diluting ethylene glycol aqueous solution) which must meet the water quality standards as mentioned below.

Clear Water (as Circulating Fluid) Quality Standards

The Japan Refrigeration and Air Conditioning Industry Association
JRA GL-02-1994 "Cooling water system – Circulation type – Make-up water"

	Item	Unit	Standard value	Influence	
				Corrosion	Scale generation
Standard item	pH (at 77°F (25°C))	—	6.0 to 8.0	○	○
	Electrical conductivity (77°F)	[μS/cm]	100* to 300*	○	○
	Chloride ion (Cl ⁻)	[mg/L]	50 or less	○	
	Sulfuric acid ion (SO ₄ ²⁻)	[mg/L]	50 or less	○	
	Acid consumption amount (at pH4.8)	[mg/L]	50 or less		○
	Total hardness	[mg/L]	70 or less		○
	Calcium hardness (CaCO ₃)	[mg/L]	50 or less		○
	Ionic state silica (SiO ₂)	[mg/L]	30 or less		○
Reference item	Iron (Fe)	[mg/L]	0.3 or less	○	○
	Copper (Cu)	[mg/L]	0.1 or less	○	
	Sulfide ion (S ₂ ⁻)	[mg/L]	Should not be detected.	○	
	Ammonium ion (NH ₄ ⁺)	[mg/L]	0.1 or less	○	
	Residual chlorine (Cl)	[mg/L]	0.3 or less	○	
	Free carbon (CO ₂)	[mg/L]	4.0 or less	○	

* In the case of [MΩ·cm], it will be 0.003 to 0.01.

○: Factors that have an effect on corrosion or scale generation.

• Even if the water quality standards are met, complete prevention of corrosion is not guaranteed.

Transportation/Transfer/Movement

Warning

1. Transportation by forklift

- It is not possible to hang this product.
- The fork insertion position is either on the left side face or right side face of the unit. Be careful not to bump the fork against a caster or level foot and be sure to put through the fork to the opposite side.
- Be careful not to bump the fork to the cover panel or piping ports.

2. Transportation by casters

- This product is heavy and should be moved by at least two people.
- Do not grip the pipings on the rear side or the handles of the panel.

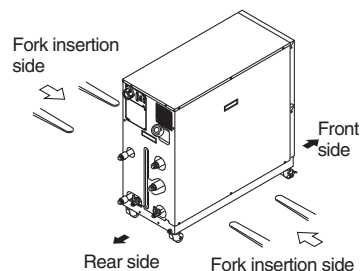



Series HRW Specific Product Precautions 2

Be sure to read this before handling. Refer to back page 1 for Safety Instructions and back pages 2 to 5 for Temperature Control Equipment Precautions.

Mounting/Installation

⚠ Caution

1. Avoid using this product outdoors.
2. Install on a rigid floor which can withstand this product's weight.
3. Please install a suitable anchor bolt for the anti-quake bracket taking into consideration the customers floor material.
4. Avoid placing heavy objects on this product.

Piping

⚠ Caution

1. Regarding the circulating fluid pipings, consider carefully the suitability for shutoff pressure, temperature and circulating fluid.

If the operating performance specifications are regularly exceeded, the pipings may burst during operation.

2. The surface of the circulating fluid pipings should be covered with the insulating materials which can effectively confine the heat.

Absorbing the heat from the surface of pipings may reduce the cooling capacity performance and the heating capacity may be shortened due to heat radiation.

3. When using fluorinated liquid as the circulating fluid, do not use pipe tape.

Liquid leakage may occur around the pipe tape.

For sealant, we recommend that you use the following sealant: SMC Part No., HRZ-S0003 (Silicone sealant)

4. For the circulating fluid pipings, use clean pipings which have no dust, oil or water moisture inside the pipings, and blow with air prior to undertaking any piping works.

If any dust, oil or water moisture enters the circulating fluid circuit, inferior cooling performance or equipment failure due to frozen water may occur, resulting in bubbles in the circulating fluid inside the tank.

5. Select the circulating fluid pipings which can exceed the required rated flow.

For the rated flow, refer to the pump capacity table.

6. For the circulating fluid piping connection, install a drain pan just in case the circulating fluid may leak.

7. Do not return the circulating fluid to the unit by installing a pump in the customer system.

Electrical Wiring

⚠ Caution

1. Power supply and signal cable should be prepared by the customer.

2. Provide a stable power supply which is not affected by surge or distortion.

If the voltage increase ratio (dV/dt) at the zero cross should exceed 40 V/200 μ sec., it may result in a malfunction.

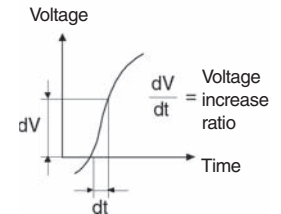

3. This product is installed with a breaker with the following operating characteristics.

For the customer's machine (inlet side), use a breaker whose operating time is equal to or longer than the breaker of this product. If a breaker with shorter operating time is connected, the customer's machine could be cut off due to the inrush current of the motor of this product.

Breaker Operating Characteristics

Common for all models

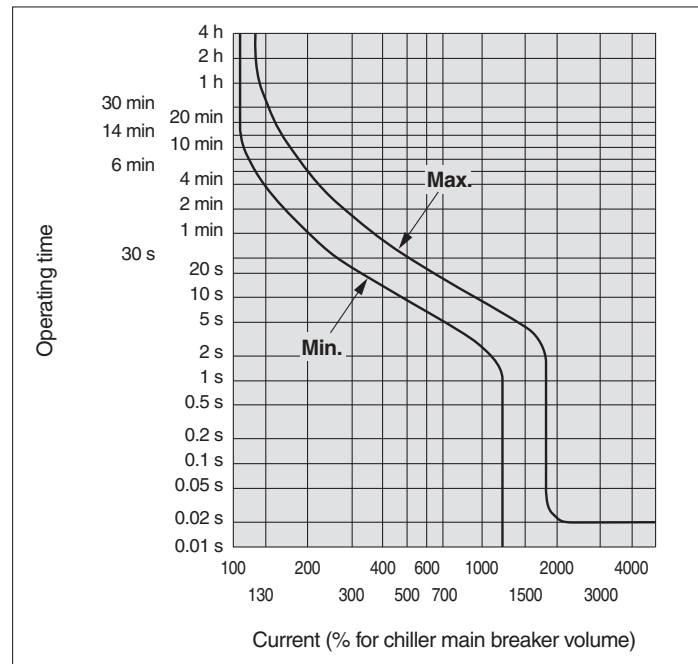



Series HRW Specific Product Precautions 3

Be sure to read this before handling. Refer to back page 1 for Safety Instructions and back pages 2 to 5 for Temperature Control Equipment Precautions.

Operation

Caution

1. Confirmation before operation

1. The circulating fluid should be within the specified range of "HIGH" and "LOW".
2. Be sure to tighten the cap for the circulating fluid port until the click sound is heard.

2. Emergency stop method

In the case of an emergency, press down the EMO switch which is fitted on the front face of this product.

Maintenance

Warning

1. Do not operate the switch with wet hands or touch electrical parts such as an electrical plug. This will lead to an electrical shock.
2. Do not splash water directly on this product for cleaning. This will lead to an electrical shock or a fire.
3. When the panel was removed for the purpose of inspection or cleaning, mount the panel after works were done.

If the panel is still open, or running the equipment with the panel removed, it may cause an injury or electric shock.

Caution

1. In order to prevent a sudden product failure of the unit, replace the replacement parts every 36 months.
2. Perform an inspection of the circulating fluid every 3 months.
 1. In the case of fluorinated fluids:
Discharge the circulating liquid and avoid any dirty objects, or water moisture, or foreign objects entering the system.
 2. In the case of ethylene glycol aqueous solution:
Maintain the condensation at 60%.
 3. In case of clear water, deionized water:
Replacement is recommended.
3. Check the water quality of facility water every 3 months.

Regarding the water quality standards for facility water, refer to "Temperature Control Equipment Precautions".

HRG

HRS

HRZ

HRZD

HRW

HEC

HEB

HED

Technical
Data

Related
Products