

Specifications

Model	NAR425	NAR435	NAR625	NAR635	NAR825	NAR835	NAR925	NAR935
Port Size	1/4 • 3/8 • 1/2		3/4 • 1		1 1/4 • 1 1/2		2	
Proof pressure psig (MPa)	220 (1.5)							
Max. operating pressure psig (MPa)	150 (1.0)							
Temperature	23~140° F (-5° ~ 60° C)							
Pressure regulating range psig (MPa)	7-120 (0.05~0.83)	3-30 (0.02~0.2)	7-120 (0.05~0.83)	3-30 (0.02~0.2)	7-120 (0.05~0.83)	3-30 (0.02~0.2)	7-120 (0.05~0.83)	3-30 (0.02~0.2)
Body	ADC, AC2A-F	ADC, AC2A-F	ADC, AC2A-F	ADC, AC2A-F	AC2A-F	AC2A-F	AC2A-F	AC2A-F
Bonnet	ADC							
Chamber	ADC, AC2A-F	ADC, AC2A-F	ADC, AC2A-F	ADC, AC2A-F	AC2A-F	AC2A-F	AC2A-F	AC2A-F
Valve guide	ZDC, AC2A-F	ZDC, AC2A-F	ZDC, AC2A-F	ZDC, AC2A-F	AC2A-F	AC2A-F	AC2A-F	AC2A-F
Weight lbs (kgf)	1.54 (0.7)		2.43 (1.1)		5.51 (2.5)		9.92 (4.5)	
Option	Bracket	B24P		B25P		—		—
	Gauge	K50A-MP1.0-N02M (0~160 psig) Std. NAR O 25						
		K50A-MP2.0-N02M (0~30 psig) Std. NAR O 35						

How To Order

NAR **4** **25** — **N** **02** **B** — **R**

Body size
 4 — 1/2
 6 — 1
 8 — 1 1/2
 9 — 2

Pressure regulating range
 25 — 7-120 psig
 35 — 3-30 psig

Pipe size (NPT)
 02 — 1/4
 04 — 1/2
 06 — 3/4
 10 — 1
 12 — 1 1/4
 14 — 1 1/2
 20 — 2

Option
 Nil — None
 R — IN-OUT Reversal (Right→Left)

Accessory
 Nil — None
 B — Bracket
 G — Gauge

Flow and Pressure Characteristics

NAR425, 435, 625, 635, 825, 835, 925, 935

Flow characteristics Condition: Supply pressure 100 psig

Pressure characteristics

Supply Pressure - 100 psi (0.7 MPa)
 Secondary Pressure - 30 psi (0.2 MPa)
 Flow - 0.7SCFM (20l/min)

NAR425 NPT 1/2

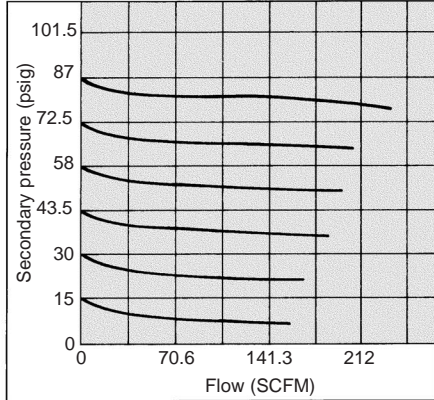

NAR435 NPT 1/2

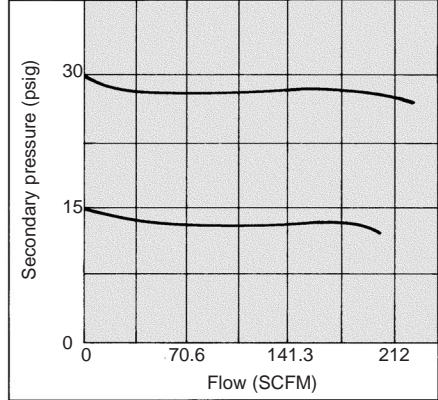

NAR425/435 NPT 1/2

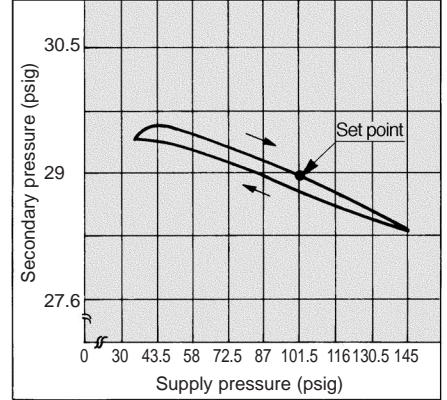

NAR625 NPT 1

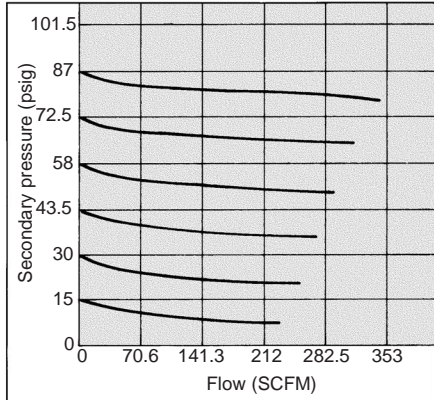

NAR635 NPT 1

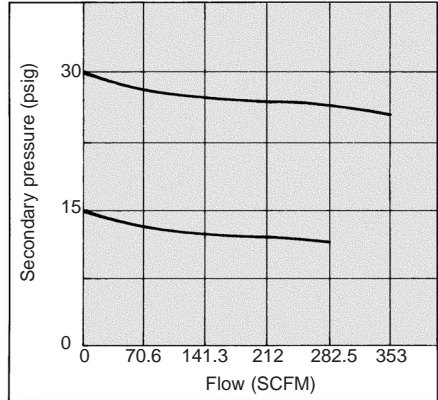

NAR625/635 NPT 1

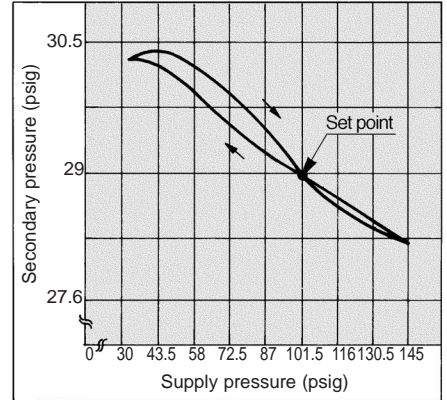

NAR825 NPT 1/2

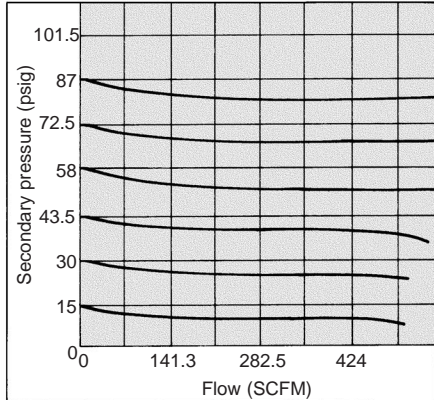

NAR835 NPT 1/2

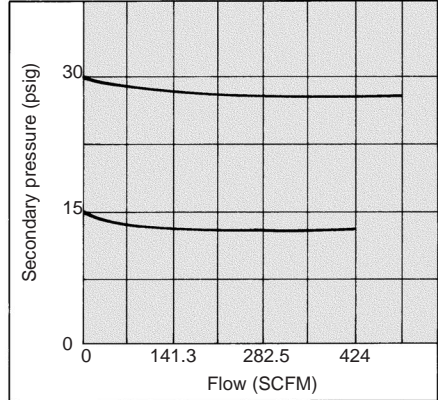

NAR825/835 NPT 1/2

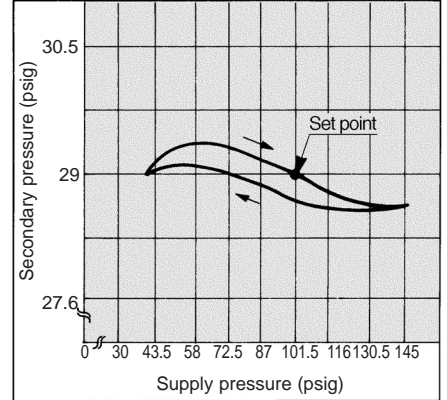

NAR925 NPT 2

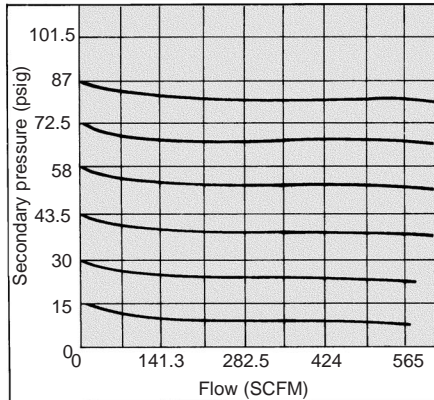

NAR935 NPT 2

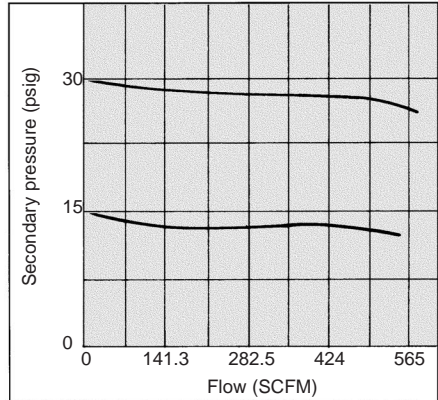

NAR925/935 NPT 2

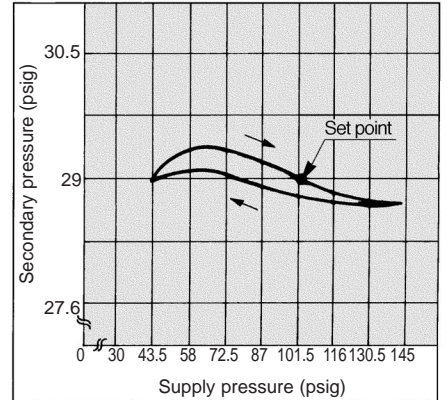

Construction

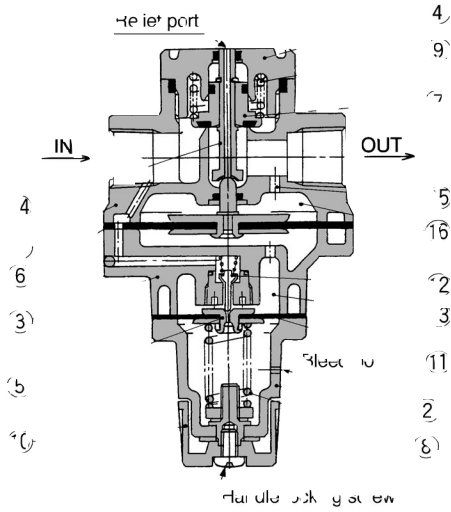

No.	Name	Material	Model			
			NAR425•435	NAR625•635	NAR825•835	NAR925•935
⑤	Exhaust valve assembly	—	132586A	132586A	132586A	132586A
⑥	Main valve diaphragm assembly	—	132581A	132659A	13275A	13285A
⑦	Valve assembly	—	132572A	132653A	132752A	132829A
⑧	Regulating spring	SWPB	135053(NAR425) 135025(NAR435)	135053(NAR625) 135025(NAR635)	135053(NAR825) 135025(NAR835)	135053(NAR925) 135025(NAR935)
⑨	Valve spring	SUS304	135211	132656	132713	13289
⑪	Pilot Diaphragm	—	135019-1A	135019-1A	135019-1A	135019-1A
	Repair Kit	—	KT-AR4□5	KT-AR6□5	KT-AR8□5	KT-AR9□5

Dimensions

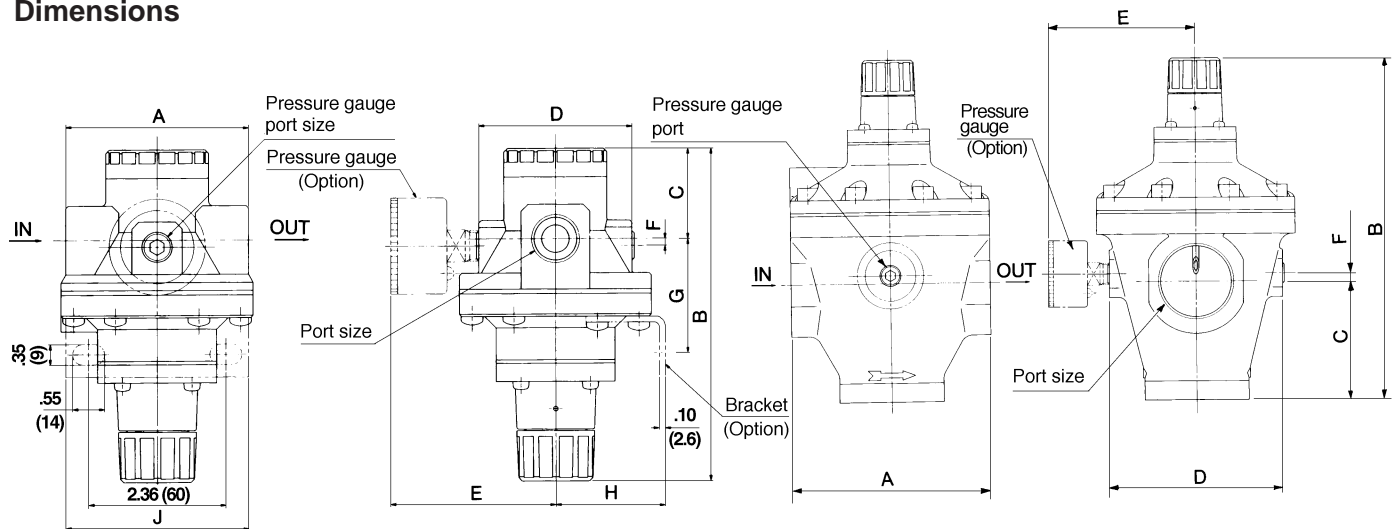

Model	A	B	C	D	E	F	Bracket Dimensions		
							G	H	J
NAR425•435	3.15 (80)	5.55 (141)	1.46 (37)	2.64 (67)	3.01 (76.5)	0.12 (3)	1.83 (46.5)	1.89 (48)	3.15 (80)
NAR625•635	3.86 (98)	5.98 (151.9)	1.57 (40)	3.07 (78)	3.23 (82)	0.28 (7)	3.35 (85)	2.05 (52)	3.54 (90)
NAR825•835	4.96 (126)	8.54 (216.9)	2.95 (75)	4.33 (110)	3.86 (98)	0.20 (5)	—	—	—
NAR925•935	6.30 (160)	9.53 (242)	3.50 (89)	5.51 (140)	4.45 (113)	0.39 (10)	—	—	—