

Series VQ5000

Base Mounted

Plug-in/Plug Lead: Single Unit

Model

Series	Number of solenoids		Model		Port size	Flow Characteristics						Response time (ms)			Weight (kg)
						1 → 4/2 (P → A/B)			4/2 → 5/3 (A/B → EA/EB)			Standard 1 W	Low wattage 0.5 W	AC	
						C _d (dm ³ /(s·bar))	b	C _v	C _d (dm ³ /(s·bar))	b	C _v				
VQ5000	2 position	Single	Metal seal	VQ51 ₅ 0	Rc 1/2	12	0.14	2.9	14	0.18	3.4	35 or less	38 or less	38 or less	0.59 (0.67)
			Rubber seal	VQ51 ₅ 1		16	0.33	4.4	17	0.31	4.7	40 or less	43 or less	43 or less	0.58 (0.66)
		Double	Metal seal	VQ52 ₅ 0		12	0.14	2.9	14	0.18	3.4	20 or less	23 or less	23 or less	0.62 (0.70)
			Rubber seal	VQ52 ₅ 1		16	0.33	4.4	17	0.31	4.7	25 or less	28 or less	28 or less	0.60 (0.68)
	3 position	Closed center	Metal seal	VQ53 ₅ 0		11	0.24	2.6	11	0.23	2.8	50 or less	53 or less	53 or less	0.65 (0.73)
			Rubber seal	VQ53 ₅ 1		12	0.33	3.4	13	0.37	3.7	60 or less	63 or less	63 or less	0.58 (0.66)
		Exhaust center	Metal seal	VQ54 ₅ 0		12	0.13	2.9	14	0.18	3.4	50 or less	53 or less	53 or less	0.65 (0.73)
			Rubber seal	VQ54 ₅ 1		14	0.39	3.9	16	0.35	4.5	60 or less	63 or less	63 or less	0.58 (0.66)
		Pressure center	Metal seal	VQ55 ₅ 0		12	0.23	2.9	13	0.24	3.3	50 or less	53 or less	53 or less	0.65 (0.73)
			Rubber seal	VQ55 ₅ 1		13	0.32	3.4	14	0.40	3.9	60 or less	63 or less	63 or less	0.58 (0.66)
		Double check	Metal seal	VQ56 ₅ 0		8.0	—	—	8.5	—	—	62 or less	65 or less	65 or less	1.17 (1.25)
			Rubber seal	VQ56 ₅ 1		8.3	—	—	9.0	—	—	75 or less	78 or less	78 or less	1.10 (1.18)

Note) Value for valve on sub-plate.



JIS Symbol

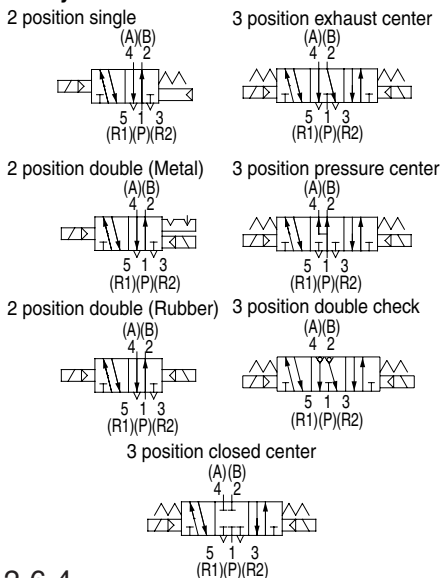

Standard Specifications

Valve specifications	Valve construction	Metal seal	Rubber seal	
	Fluid	Air/Inert gas		
	Maximum operating pressure ⁽³⁾	1.0 MPa		
	Min. operating pressure	Single	0.10 MPa	0.20 MPa
		Double	0.10 MPa	0.15 MPa
		3 position	0.15 MPa	0.20 MPa
	Proof pressure	1.5 MPa		
	Ambient and fluid temperature	-5 to 50°C ⁽¹⁾		
	Lubrication	Not required		
	Manual override	Push type/Locking type (Tool required) Option		
Shock/Vibration resistance	150/30 m/s ² ⁽²⁾			
Protection structure	Dust tight (IP65 compatible)			
Solenoid specifications	Coil rated voltage	12, 24 VDC, 100, 110, 200, 220 VAC (50/60 Hz)		
	Allowable voltage fluctuation	±10% of rated voltage		
	Coil insulation type	Class B or equivalent		
	Power consumption (Current)	24 VDC	1 W DC (42 mA), 0.5 W DC (21 mA) ⁽³⁾	
		12 VDC	1 W DC (83 mA), 0.5 W DC (42 mA) Note ⁽³⁾	
100 VAC		Inrush 1.2 VA (12 mA), Holding 1.2 VA (12 mA)		
110 VAC		Inrush 1.3 VA (11.7 mA), Holding 1.3 VA (11.7 mA)		
200 VAC		Inrush 2.4 VA (12 mA), Holding 2.4 VA (12 mA)		
220 VAC	Inrush 2.6 VA (11.7 mA), Holding 2.6 VA (11.7 mA)			



Note 1) Use dry air to prevent condensation when operating at low temperatures.

Note 2) Impact resistance: No malfunction occurred when it is tested with a drop tester in the axial direction and at the right angles to the main valve and armature in both energized and de-energized states every once for each condition. (Values at the initial period)

Vibration resistance: No malfunction occurred in a one-sweep test between 45 and 2000 Hz. Test was performed at both energized and de-energized states in the axial direction and at the right angles to the main valve and armature. (Values at the initial period)

Note 3) Values inside () denote the low wattage (0.5 W) specifications.

Plug-in/Plug Lead: Single Unit Series VQ5000

Plug Lead Type

Grommet

2 position single: VQ515⁰-□^G_H

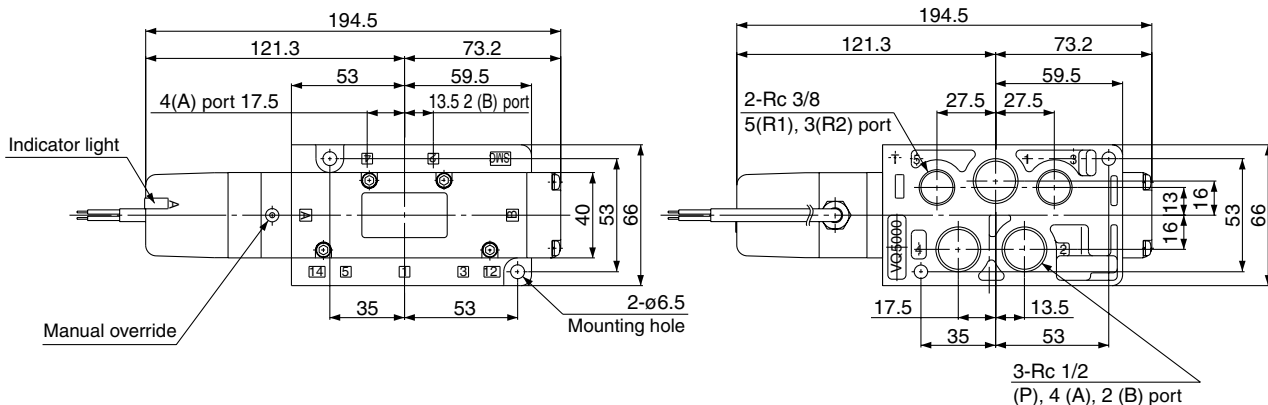

VQC

SQ

VQ0

VQ4

VQ5

VQZ

VQD

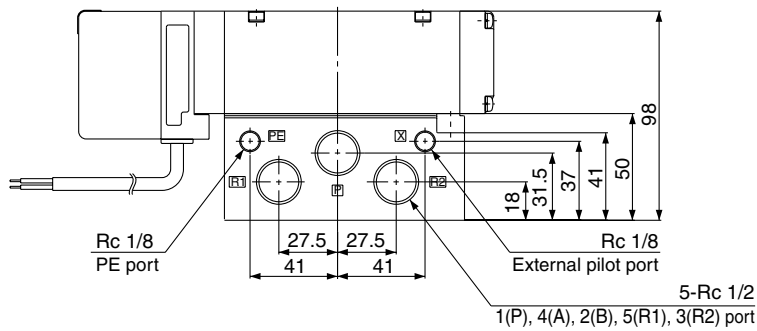

Bottom ported drawing

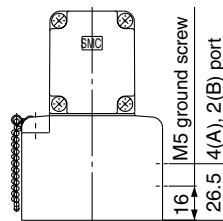

2 position double: VQ525⁰-□^G_H

3 position closed center: VQ535⁰-□^G_H

3 position exhaust center: VQ545⁰-□^G_H

3 position pressure center: VQ555⁰-□^G_H

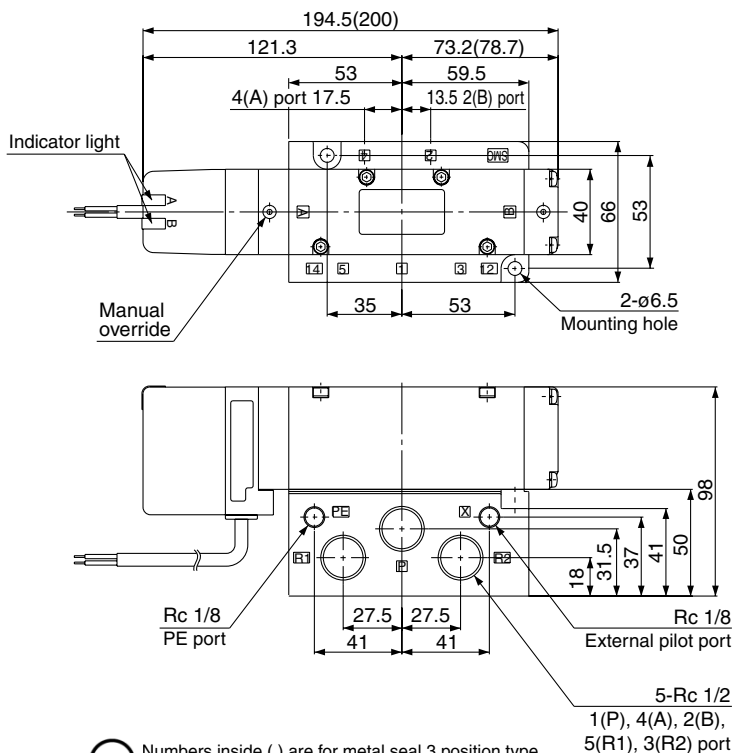

Numbers inside () are for metal seal 3 position type

3 position double check: VQ565⁰-□^G_H

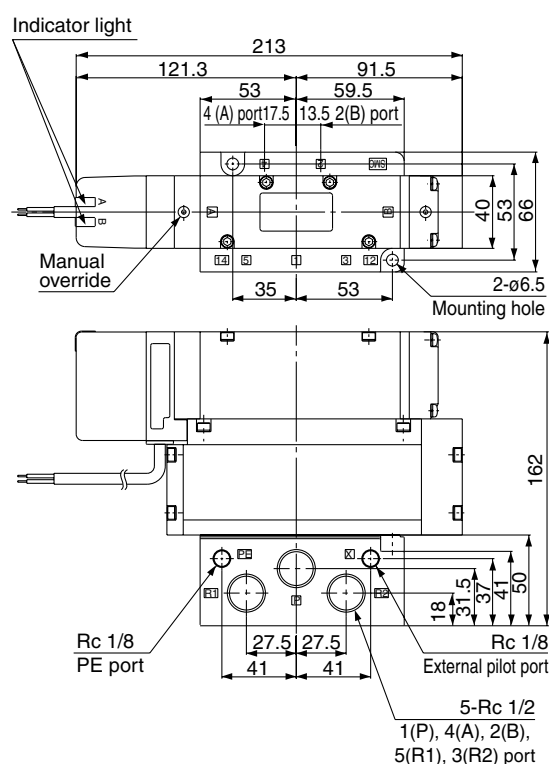

Series VQ5000

Base Mounted

Plug Lead Unit: C Kit (Connector Kit)

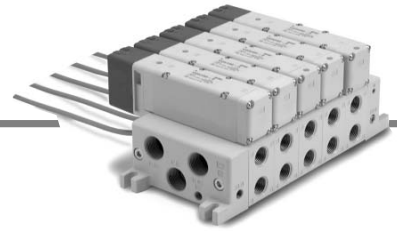

How to Order Manifold

VV5Q 5 5 - 08 03 C-W

Series	
5	VQ5000
Manifold	
5	Plug lead unit
Stations	
01	1 station
⋮	⋮
12	12 stations
Cylinder port	
03	Rc 3/8
04	Rc 1/2
B	Bottom ported Rc 1/2
CM	Mixed

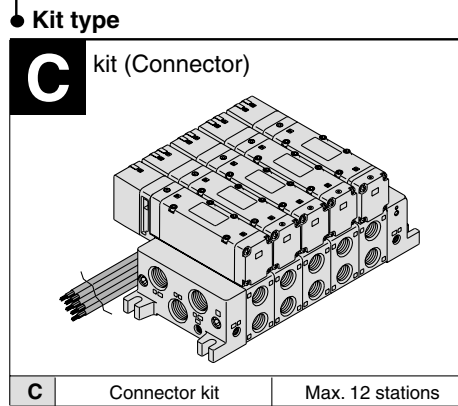

C	Connector kit	Max. 12 stations
----------	---------------	------------------

Option

Symbol	Option
Nil	None
CD1 ^{Note}	Exhaust cleaner for Rc 1: D side exhaust
CD2 ^{Note}	Exhaust cleaner for Rc 1 1/2: D side exhaust
CU1 ^{Note}	Exhaust cleaner for Rc 1: U side exhaust
CU2 ^{Note}	Exhaust cleaner for Rc 1 1/2: U side exhaust
SB	Direct exhaust with silencer box: Exhaust from both U and D sides
SD ^{Note}	Direct exhaust with silencer box: D side exhaust
SU ^{Note}	Direct exhaust with silencer box: U side exhaust
W	IP65 enclosure

Note) Combination of [C_D^U] and [S_D^U] is not possible.



Refer to page 2-6-2 (Grommet style) for wiring specifications.

How to Order Valves

VQ 5 1 5 0 - 5 G

Series	
5	VQ5000
Type of actuation	
1	2 position single
2	2 position double
3	3 position closed center
4	3 position exhaust center
5	3 position pressure center
6	3 position double check

Seal	
0	Metal seal
1	Rubber seal

Function	
Nil	Standard type (1 W)
Y ⁽¹⁾	Low wattage type (0.5 W)
R ⁽²⁾	External pilot

Note 1) Applicable to DC specification.
 Note 2) Refer to page 2-6-39 for details on external pilot specifications.



Note 3) When two or more symbols are specified, indicate them alphabetically.

Coil voltage			
1	100 VAC (50/60 Hz)	4	220 VAC (50/60 Hz)
2	200 VAC (50/60 Hz)	5	24 VDC
3	110 VAC (50/60 Hz)	6	12 VDC

Enclosure

Nil	Dusttight
W	Dusttight/Low jetproof type (IP65)

Manual override

Nil: Non-locking push type (Tool required)

B: Locking type (Tool required)

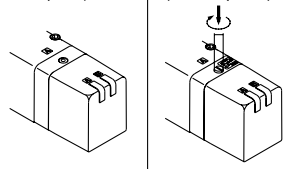

Light/Surge voltage suppressor

Nil	Yes
E	Without light, with surge voltage suppressor

Electrical entry

Grommet	G Lead wire length 0.6 m	
	H Lead wire length 1.5 m	

How to Order Manifold Assembly

Specify the part numbers for valves and options together beneath the manifold base part number.

<Example> Connector kit

W5Q55-05042C-z-1 set — Manifold base part no.
 * VQ5150-5G 2 sets — Valve part no. (Stations 1 and 2)
 * VQ5250-5G 2 sets — Valve part no. (Stations 3 and 4)
 * VQ5350-5G 1 set — Valve part no. (Station 5)

Prefix the asterisk to the part nos. of the solenoid valve, etc.

Enter in order starting from the first station on the D side. When entry of part numbers becomes complicated, indicate in the manifold specification sheet.

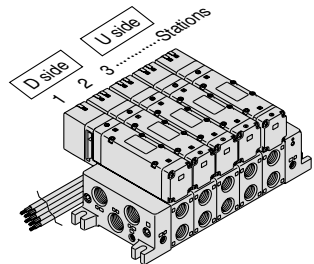

Manifold Specifications

Series	Base model	Type of connection	Porting specifications			Maximum applicable stations	Applicable solenoid valve	5 station weight (kg)
			4(A), 2(B) port location	Port size ^{Note)}				
				1(P), 5(R1), 3(R2)	4(A), 2(B)			
VQ5000	VV5Q55-□□□	■ C kit-Grommet	Side	Rc 3/4 Option (Direct exhaust with silencer box)	Rc 3/8 Rc 1/2	2 to 12 stations	VQ5□50 VQ5□51	3.7 • Except solenoid valve weight
			Bottom		Rc 1/2			

Note) For details about international standard threads other than Rc threads, refer to "Option" on page 2-6-39.

Flow Characteristics at the Number of Manifold Stations (Operated individually)

Model	Passage/Stations		Station 1	Station 5	Station 10
2 position metal seal VQ5 ₂ 100	1 → 4/2 (P → A/B)	C [dm ³ /(s-bar)]	11	11	11
		b	0.24	0.24	0.24
		Cv	2.7	2.7	2.7
	4/2 → 5/3 (A/B → EA/EB)	C [dm ³ /(s-bar)]	12	12	12
		b	0.14	0.14	0.14
		Cv	2.9	2.9	2.9
2 position rubber seal VQ5 ₂ 01	1 → 4/2 (→ RA/B)	C [dm ³ /(s-bar)]	12	12	12
		b	0.33	0.33	0.33
		Cv	3.4	3.4	3.4
	4/2 → 5/3 (A/B → EA/EB)	C [dm ³ /(s-bar)]	16	16	16
		b	0.33	0.33	0.33
		Cv	4.4	4.4	4.4

Note) For port size Rc 1/2

Manifold Option

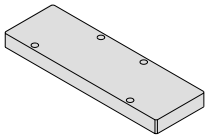
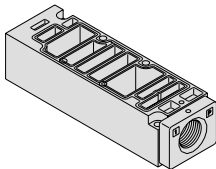
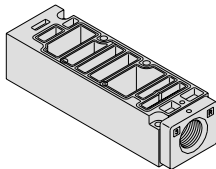
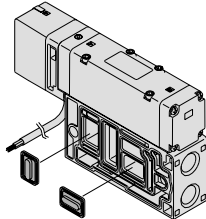
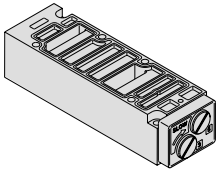
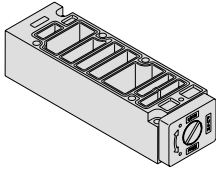
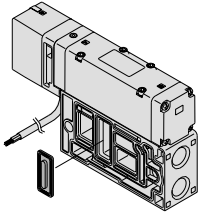
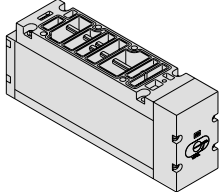
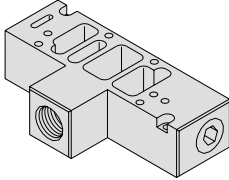
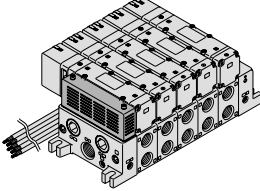
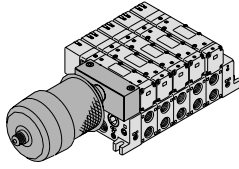
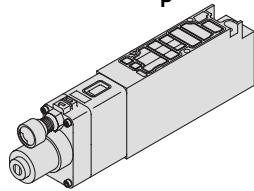
Blanking plate assembly VVQ5000-10A-5 	Individual SUP spacer VVQ5000-P-5⁰³₀₄ 	Individual EXH spacer VVQ5000-R-5⁰³₀₄ 	EXH block plate VVQ5000-16A-2 
Throttle valve spacer VVQ5000-20A-5 	SUP stop valve spacer VVQ5000-37A-5 	SUP block plate VVQ5000-16A-1 	Double check spacer with residual pressure release valve VVQ5000-25A-5 
Release valve spacer VVQ5000-24A-5D 	Direct exhaust with silencerbox [-S□] 	For exhaust cleaner mounting [-C□□] 	Interface regulator ARBQ5000-00-^A_B-5 

• Refer to pages 2-6-34 to 2-6-39 for detailed dimensions of each option.
 For replacement parts, refer to page 2-6-43.



VQC

SQ

VQ0

VQ4

VQ5

VQZ

VQD

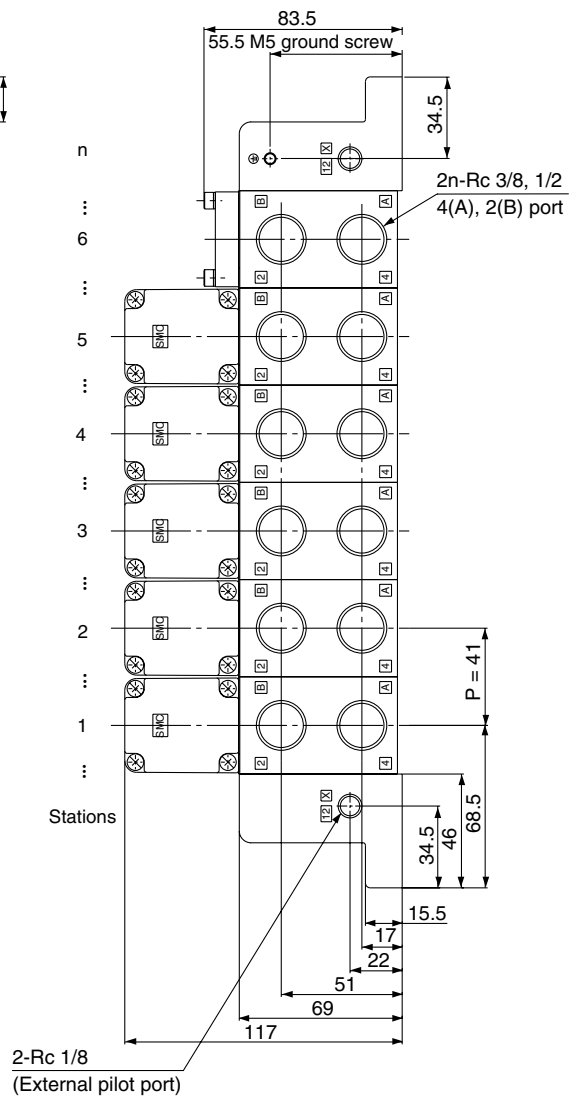
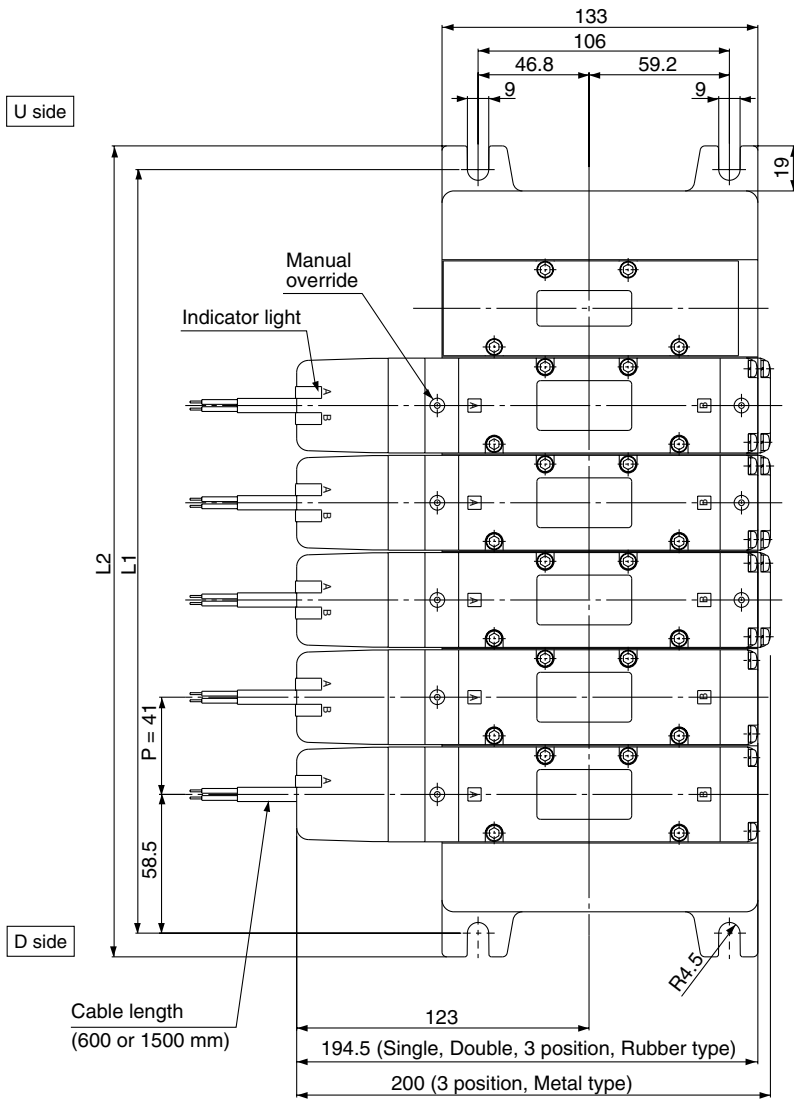
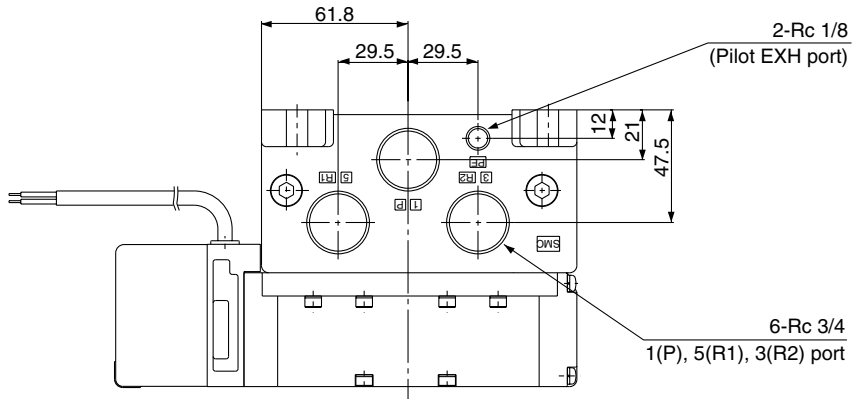

Bottom ported drawing

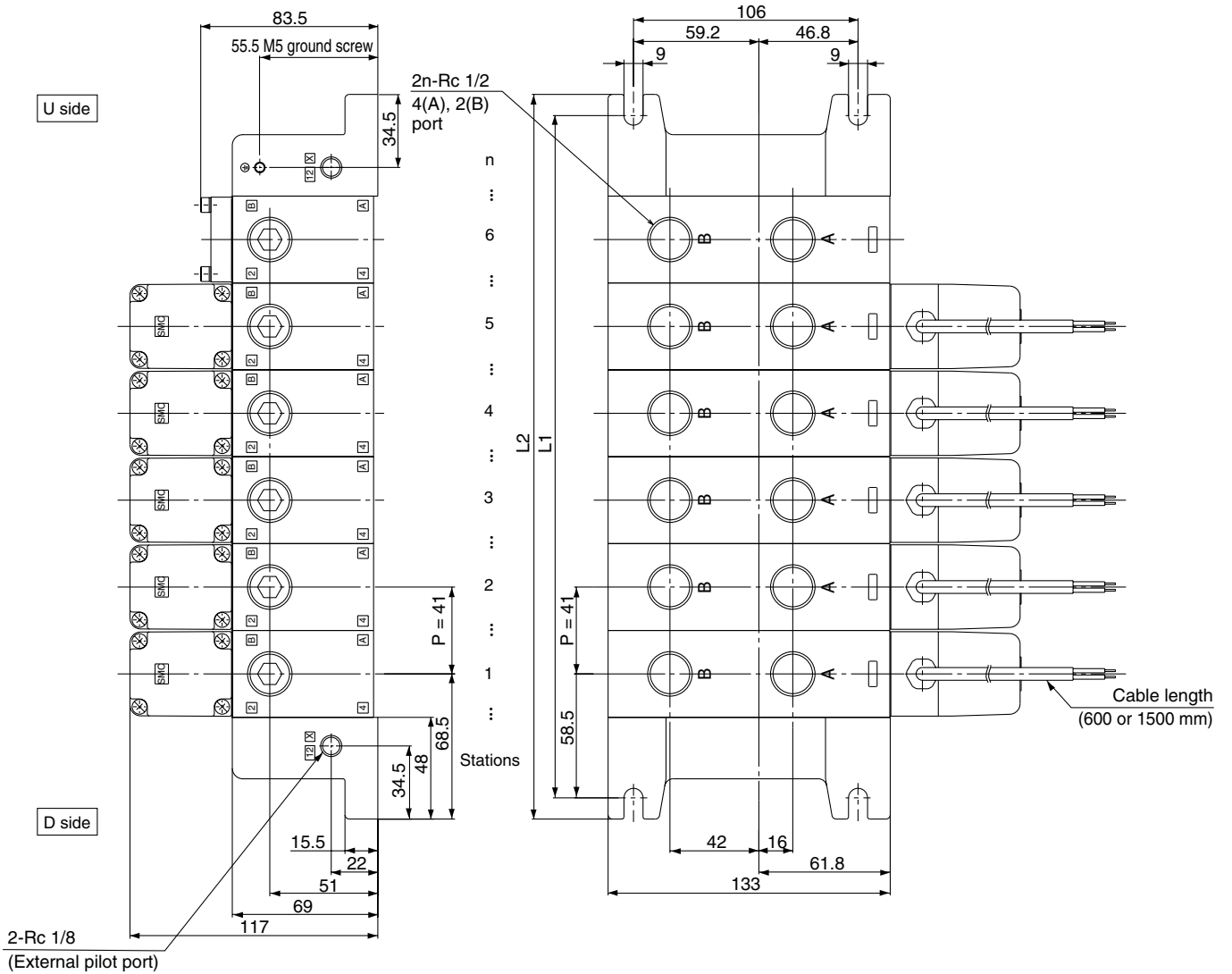

- VQC
- SQ
- VQ0
- VQ4
- VQ5**
- VQZ
- VQD

Dimensions

Formula: $L_1 = 41n + 76$, $L_2 = 41n + 96$
 n: Stations (Maximum 12 stations)

L \ n	1	2	3	4	5	6	7	8	9	10	11	12
L1	117	158	199	240	281	322	363	404	445	486	527	568
L2	137	178	219	260	301	342	383	424	465	506	547	588

Series VQ5000

Manifold Option Parts

Blanking plate assembly

- VVQ5000-10A-1 (Plug-in type)
- VVQ5000-10A-5 (Plug lead type)

It is used by attaching on the manifold block for being prepared for removing a valve for maintenance reasons or planning to mount a spare valve, etc.

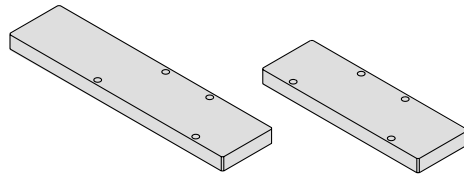

Plug-in type

Plug lead type

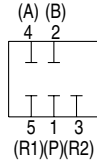

Circuit diagram

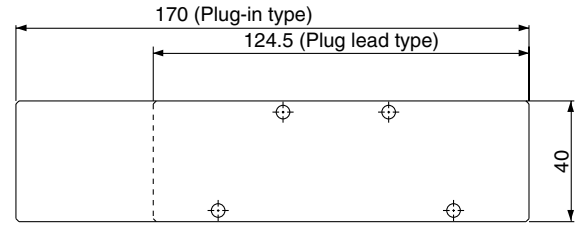

Individual SUP spacer

- VVQ5000-P-1-⁰³/₀₄ (Plug-in type)
- VVQ5000-P-5-⁰³/₀₄ (Plug lead type)

By mounting individual SUP spacers on a manifold block, it is possible to provide individual supply ports for each valve.

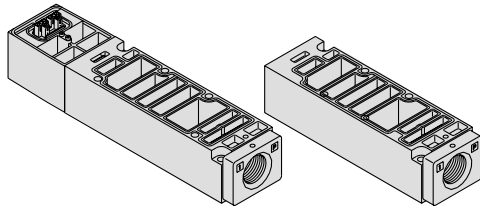

Plug-in type

Plug lead type

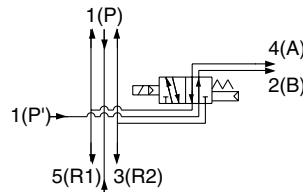

Circuit diagram

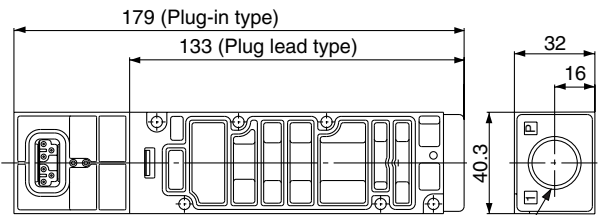

Individual EXH spacer

- VVQ5000-R-1-⁰³/₀₄ (Plug-in type)
- VVQ5000-R-5-⁰³/₀₄ (Plug lead type)

By mounting individual EXH spacers on a manifold block, exhaust ports can be provided individually for each valve. (Common EXH type)

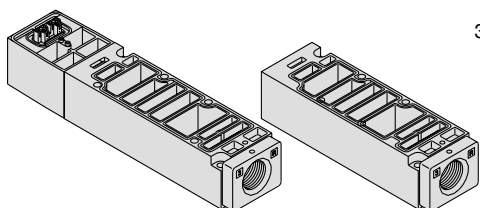

Plug-in type

Plug lead type

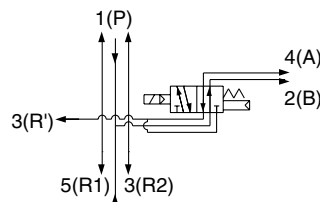

Circuit diagram

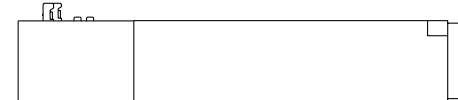
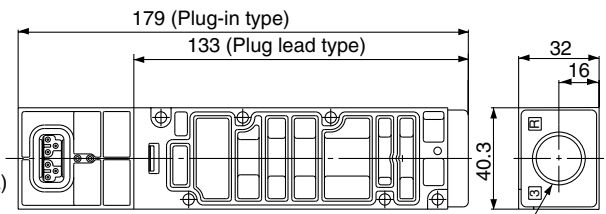

Throttle valve spacer

VVQ5000-20A-1 (Plug-in type)
VVQ5000-20A-5 (Plug lead type)

A throttle valve spacer is mounted on a manifold block to control cylinder speed by throttling exhaust air flow.

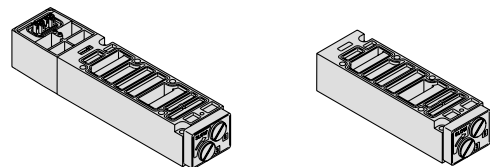

Plug-in type

Plug lead type

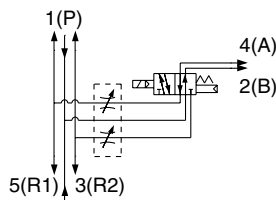

Circuit diagram

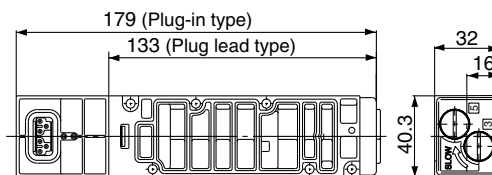

SUP stop valve spacer

VVQ5000-37A-1 (Plug-in type)
VVQ5000-37A-5 (Plug lead type)

A SUP stop valve spacer is mounted on a manifold block, making it possible to individually shut off supply air to each valve.

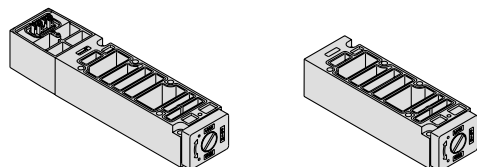

Plug-in type

Plug lead type

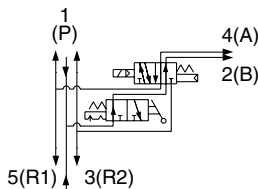

Circuit diagram

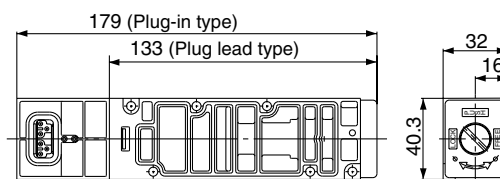

Release valve spacer: For D side mounting

VVQ5000-24A-1D (Plug-in type)
VVQ5000-24A-5D (Plug lead type)

A VQ51□□ (single) valve can be used as an air release valve by combining it with a release valve spacer.
Note) 2 position double and 3 position cannot be mounted.

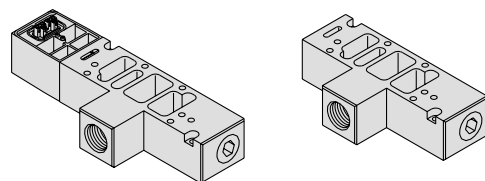

Plug-in type

Plug lead type

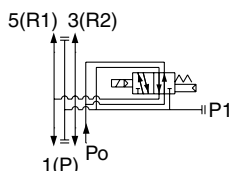

Circuit diagram

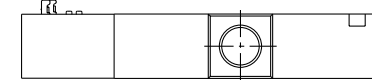
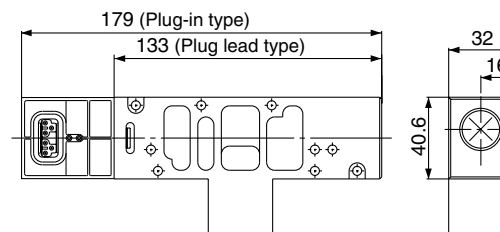

SUP block plate

VVQ5000-16A-1

EXH block plate

VVQ5000-16A-2

When different pressures, high and low, are supplied to manifold, a SUP block plate is inserted between the stations under different pressures.

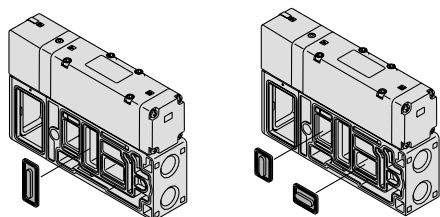

< SUP blocking plate >

< EXH blocking plate >

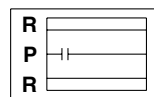
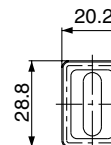
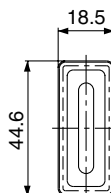

SUP passage blocked

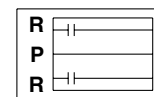

EXH passage blocked

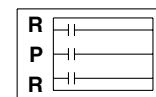

SUP/EXH passage blocked

VQC

SQ

VQ0

VQ4

VQ5

VQZ

VQD

Series VQ5000

Manifold Option Parts

Double check spacer with residual pressure release valve

VVQ5000-25A-1 (Plug-in type)
 VVQ5000-25A-5 (Plug lead type)

Can hold an intermediate cylinder position for an extended time.

When combined with a double check spacer with built-in double check valve, it is unaffected by air leakage between the spool valves, making it possible to hold a cylinder at an intermediate stopping position for an extended time.

Further, a combination of a 2 position type (VQ5₂ □□) and a double check spacer can be used for drop prevention.

Plug-in type

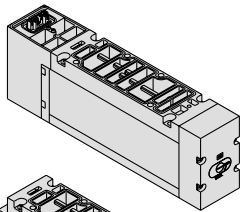

Plug lead type

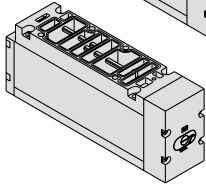

Specifications

Double check spacer part no.	VVQ5000-25A- ₁ / ₅			
	Intermediate stop	Drop prevention		
Applicable solenoid valve	VQ54□□	VQ5 ₂ □□		
Leakage N cm ³ /min	One solenoid energized	1(P)	5 (R1) 3 (R2)	320 or less
		Both solenoids unenergized	1(P)	
	Both solenoids unenergized	4(A)	5 (R1)	0
		2(B)	3 (R2)	

* Supply pressure: 0.5 MPa

Caution

Handling Precautions

- In the case of 3 position double check (VZS65₃□□), check the leakage from piping and fittings in between valve and cylinder by means of synthetic detergent solutions, and ensure that there is no such leakage found there. Also check the leakage from cylinder seal and piston seal. If there is any leakage, sometimes the cylinder, when valve is de-energized, can move without stopping at intermediate position.
- Use caution, as excessive throttling of the double check spacer exhaust can cause a loss of intermediate stopping accuracy and malfunction.
- Combination with a 3 position VQ5₃□□ is not possible.
- Set the cylinder load so that the cylinder pressure will be within two times that of the supply pressure.

Direct exhaust with silencer box

VV5Q5₁-□□□-SD (D side exhaust)
 VV5Q5₁-□□□-SU (U side exhaust)
 VV5Q5₁-□□□-SB (Double side exhaust)

The EXH outlet is placed on the top side of the manifold end plate. The built-in silencer provides highly effective noise reduction. (Noise reduction of 35 dB or more)

Note) Note that when excessive drainage occurs in the air supply, the drainage will be released along with the exhaust.

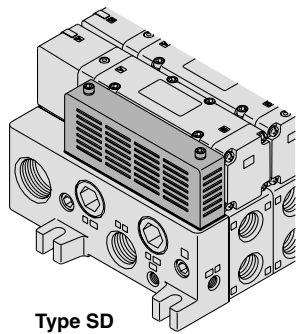
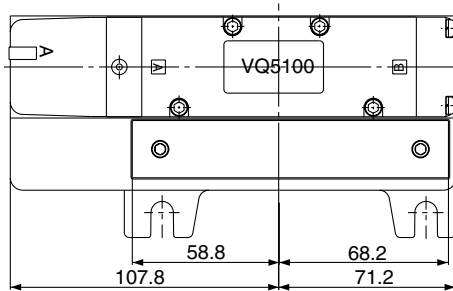

Type SD

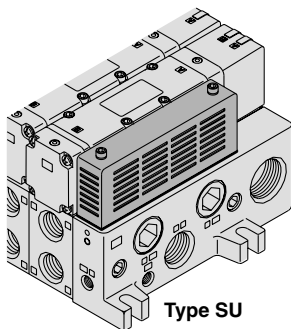

Type SU

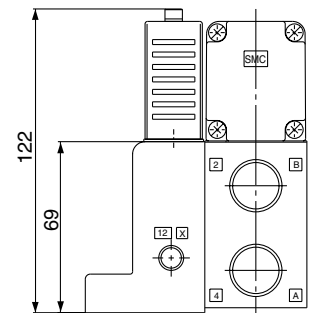
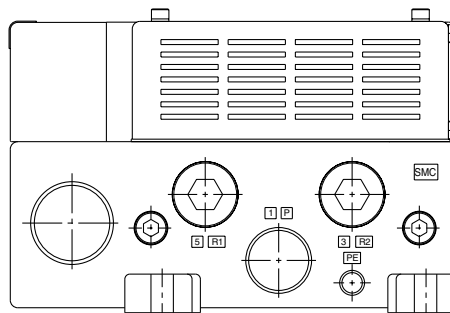

Note) The drawing shows a VV5Q51-□□□-SD.

Manifold mounted exhaust cleaner

VV5Q5¹-□□□-CD (D side mounting)
VV5Q5¹-□□□-CU (U side mounting)

An adapter plate for exhaust cleaner mounting is provided on the top of the manifold end plate. The exhaust cleaner collects drainage and oil mist (99.9% or more) and is highly effective for noise reduction. (Noise reduction of 35 dB or more)

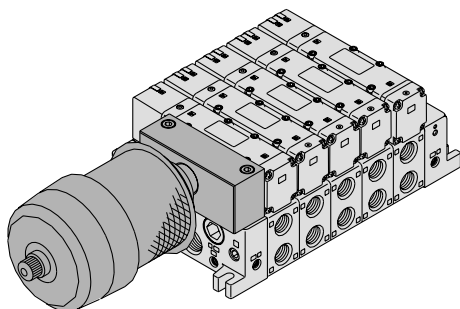

Applicable exhaust cleaners

AMC610-10 (Port size Rc 1), AMC810-14 (Port size Rc 1 1/2)

- Note 1) Exhaust cleaner: AMC610-10 and MC810-14 are not included. (Order separately)
- Note 2) Mount so that the exhaust cleaner is at the lower side.
- Note 3) For details about the exhaust cleaner, refer to Best Pneumatics vol.5.

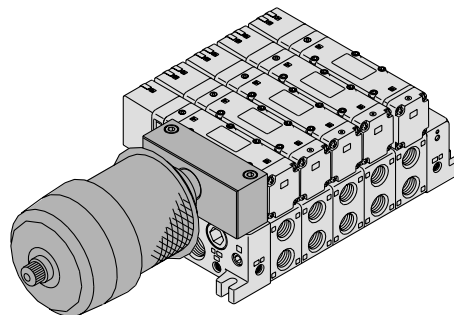

- VQC
- SQ
- VQ0
- VQ4
- VQ5**
- VQZ
- VQD

Plug-in type

Plug lead type

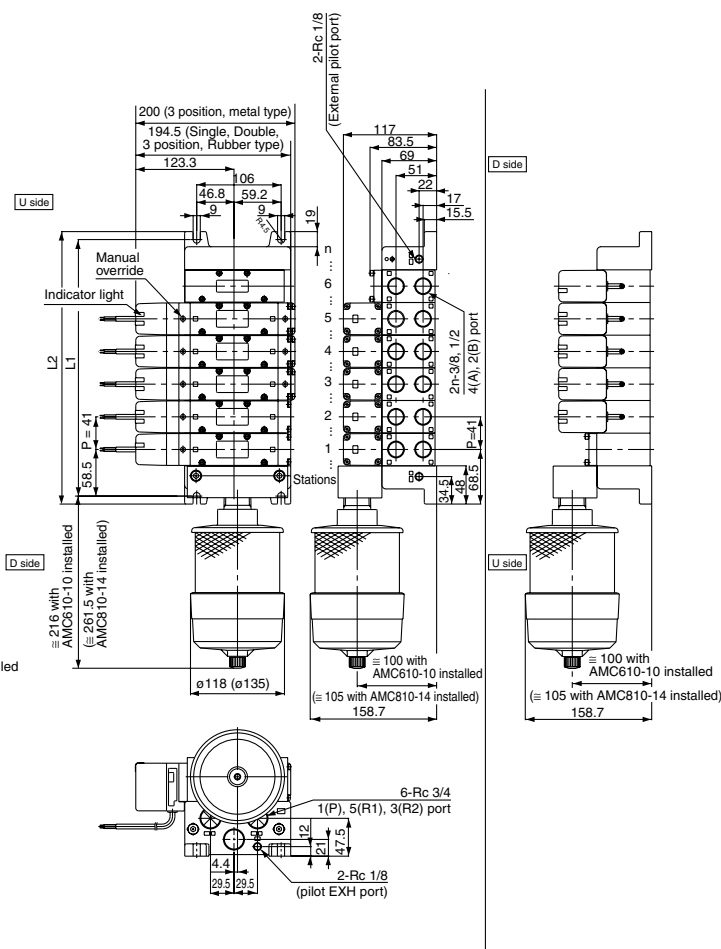
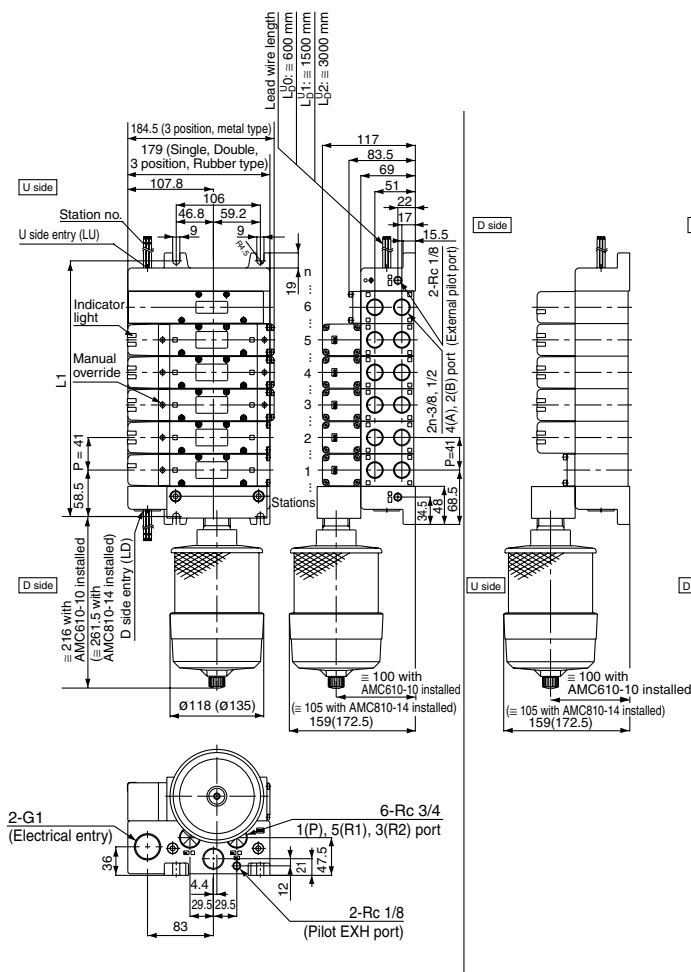

Dimensions

Formula: $L1 = 41n + 76$, $L2 = 41n + 96$
 n: Stations (Maximum 12 stations)

L	n	2	3	4	5	6	7	8	9	10	11	12
L1		158	199	240	281	322	363	404	445	486	527	568
L2		178	219	260	301	342	383	424	465	506	547	588

Dimensions

Formula: $L1 = 41n + 76$, $L2 = 41n + 96$
 n: Stations (Maximum 12 stations)

L	n	2	3	4	5	6	7	8	9	10	11	12
L1		158	199	240	281	322	363	404	445	486	527	568
L2		178	219	260	301	342	383	424	465	506	547	588

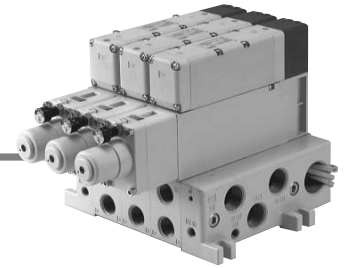

Manifold Option Parts

Interface regulator (P, A, B port regulation)

ARBQ5000-00-□-1 (Plug-in type)

ARBQ5000-00-□-5 (Plug lead type)

By mounting a spacer regulator on the manifold block, it enables to regulate pressure per every valve.

Specifications

Interface regulator		ARBQ5000					
Regulating port		A		B		P	
Applicable solenoid valve		Plug-in	Plug lead	Plug-in	Plug lead	Plug-in	Plug lead
Maximum operating pressure		1.0 MPa					
Set pressure range		0.05 to 0.85 MPa					
Fluid		Air					
Ambient and fluid temperature		-5 to 60°C (No freezing)					
Port size for connection of pressure gauge		M5 x 0.8					
Weight (kg)		0.79	0.74	0.78	0.73	0.79	0.74
Effective area at supply side (mm ²) S at P1 = 0.7 MPa/P2 = 0.5 MPa	P → A	33		75		29	
	P → B	64		33		28	
Effective area at exhaust side (mm ²) S at P2 = 0.5 MPa	A → EA	36		75		78	
	B → EB	68		38		69	

- Note 1) Set the pressure within the operating pressure range of the solenoid valve.
- Note 2) Use a spacer regulator by pressurizing from the P port on the base except the case of being used as a dual pressure valve. Besides, P port regulation is not allowed to use.
- Note 3) When using a perfect spacer, assemble a valve, a spacer regulator and a perfect spacer in this order to use it.
- Note 4) When using in A port regulation, B port regulation by closed center, since there is a problem in its operation, please contact SMC.
- Note 5) Dusttight/splash proof enclosure (IP65) is not available with interface regulator.

How to Order

Solenoid valve	Interface regulator	Regulating port
VQ5□□ (Plug-in type)	ARBQ5000-00-A-1	A
	ARBQ5000-00-B-1	B
	ARBQ5000-00-P-1	P
VQ5□5□ (Plug lead type)	ARBQ5000-00-A-5	A
	ARBQ5000-00-B-5	B
	ARBQ5000-00-P-5	P

Dimensions

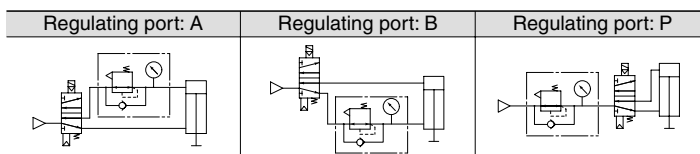
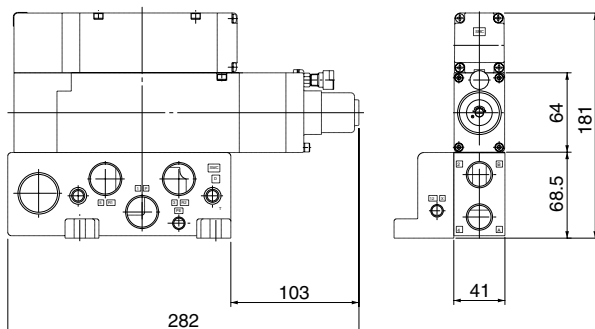

Flow Characteristics

Conditions Inlet pressure: 0.7 MPa

ARBQ5000-00-A (P → A)

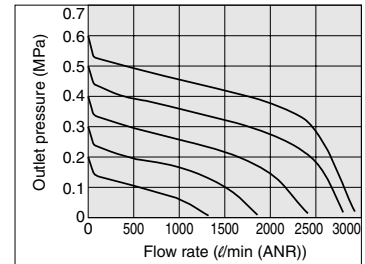

ARBQ5000-00-B (P → B)

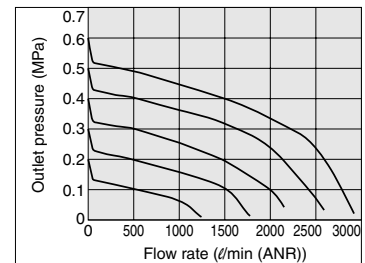

ARBQ5000-00-P (P → A)

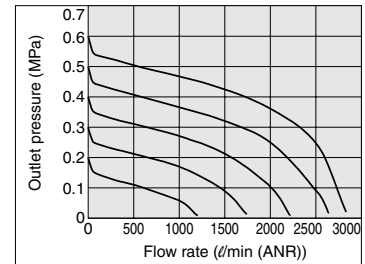

ARBQ5000-00-P (P → B)

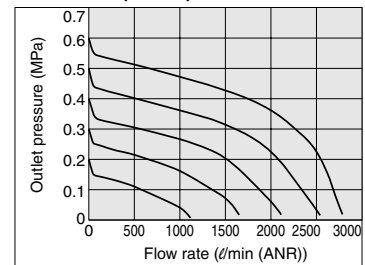

Pressure Characteristics

Conditions

Inlet pressure: 0.7 MPa

Outlet pressure: 0.2 MPa

Flow rate: 20 l/min(ANR)

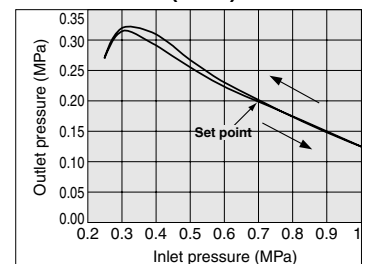

Option

External Pilot Specifications

When the supply pressure is

- lower than the minimum solenoid valve operating pressure of 0.1 to 0.2 MPa, or when it drops below this level,
- used for reverse pressure (R port pressure) or cylinder pressure (A, B port pressure),
- used for vacuum specifications (please contact SMC), it can be used for external pilot specifications.

Order a valve by adding the external pilot specification [R] to the part number.

External pilot is available as standard for manifolds and options.

How to Order Manifold

VQ5100 **R** — 5 — 04

● External pilot specifications

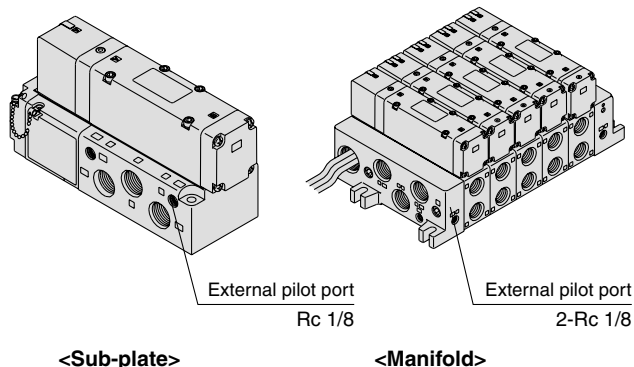

Note) Mixed mounting of internal and external pilots is possible

Pressure Specifications

Valve construction		Metal seal	Rubber seal
Operating pressure range		Vacuum to 1.0 MPa	
External pilot ^{Note)} pressure range	Single	0.1 to 1.0 MPa (0.1 to 0.7 MPa)	0.2 to 1.0 MPa (0.2 to 0.7 MPa)
	Double		0.15 to 1.0 MPa (0.15 to 0.7 MPa)
	3 position	0.15 to 1.0 MPa (0.15 to 0.7 MPa)	0.2 to 1.0 MPa (0.2 to 0.7 MPa)

Note) Values inside () denote the low wattage (0.5 W) specifications.

International Thread Standards Other than Rc

Rc specifications are standard for all ports, however, NPT, NPTF and G are available for international markets.

Add the appropriate symbol following the port size in the standard part number.

How to Order Single Valves (Example)

VQ5100 — 5 — 04

● Cylinder port
● Port size

● Thread type
1(P), 5(R1), 3(R2) and 4(A),
2(B) port

Nil	Rc
N	NPT
T	NPTF
F	G

How to Order Manifold

VV5Q51 — 08 — 03 FU1

● Cylinder port
● Port size

● Thread type
1(P), 5(R1), 3(R2) and 4(A),
2(B) port

Nil	Rc
N	NPT
T	NPTF
F	G

How to Order Sub-plates and Options (Example)

VQ5000 — P — B 04 (Sub-plate)

VVQ5000 — P — 1 — 04 (Option)

● Port size

● Thread type

Nil	Rc
N	NPT
T	NPTF
F	G

VQC

SQ

VQ0

VQ4

VQ5

VQZ

VQD

Series VQ5000 Construction

Plug Lead Unit

Metal seal

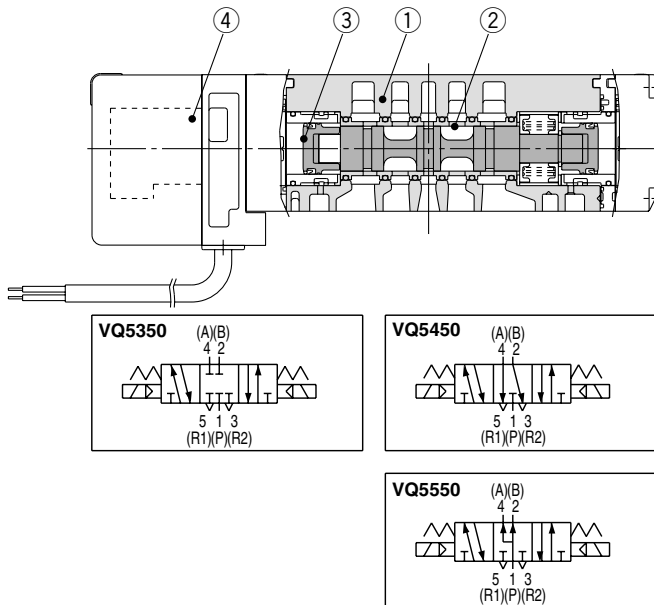
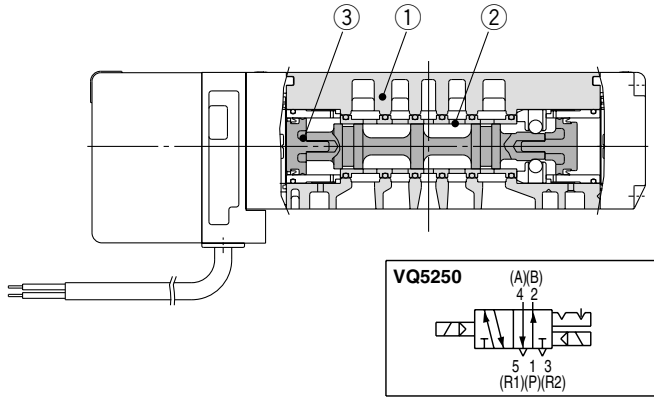
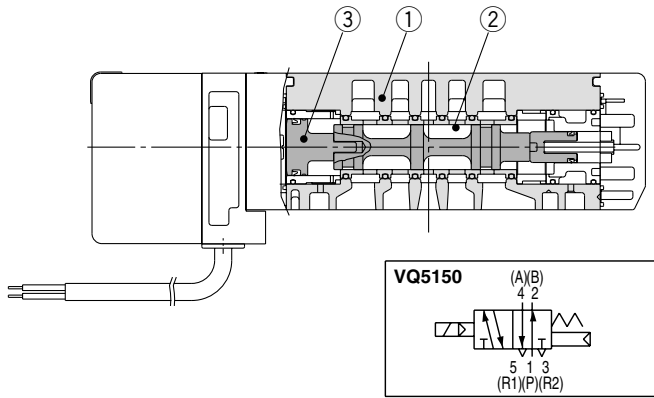

Component Parts

Number	Description	Material	Note
①	Body	Aluminum die-casted	
②	Spool/Sleeve	Stainless steel	
③	Piston	Resin	

Replacement Parts

④	Pilot valve assembly	VQZ111P-□	* Coil rated voltage Example) 24 VDC: 5
---	----------------------	-----------	--

Rubber seal type

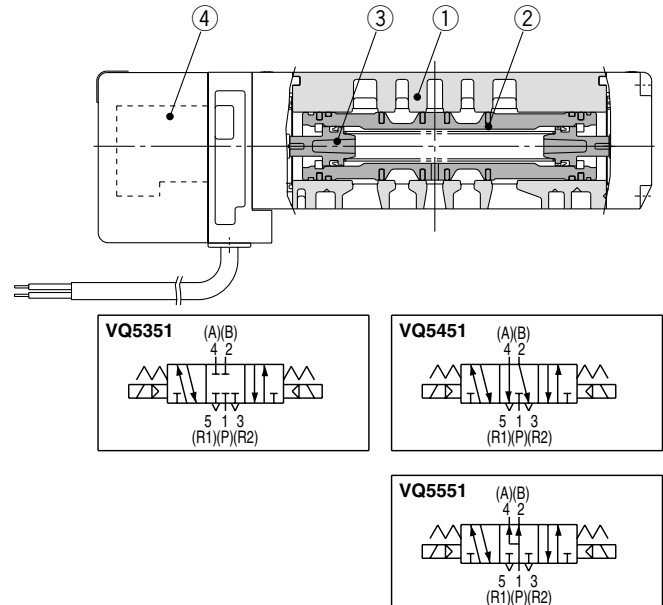
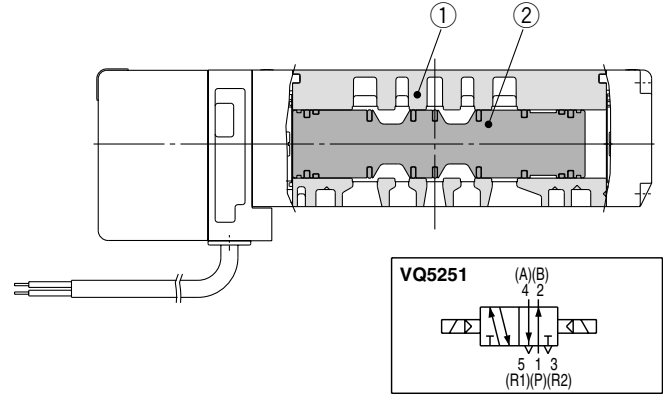
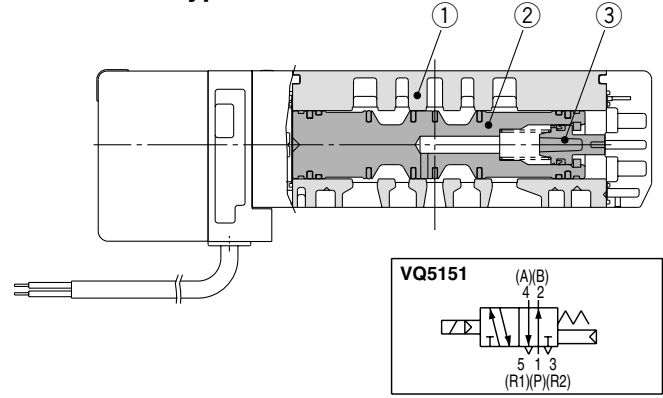

Component Parts

Number	Description	Material	Note
①	Body	Aluminum die-casted	
②	Spool valve	Aluminum, NBR	
③	Piston	Resin	

Replacement Parts

④	Pilot valve assembly	VQZ111P-□	* Coil rated voltage Example) 24 VDC: 5
---	----------------------	-----------	--

VQC

SQ

VQ0

VQ4

VQ5

VQZ

VQD